

FREUD

Double Flute

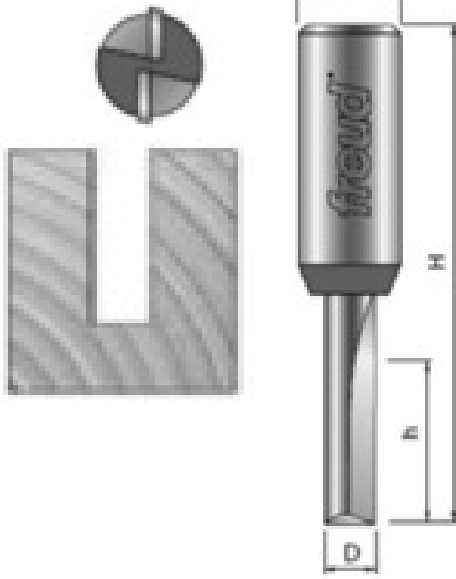

ROUTER BITS

DoubleFlute Straight Bits - Metric Version

PART	(D) OVERALL DIA.	(R) CARBIDE HEIGHT	(A) SHANK DIA.	(H) OVERALL LENGTH	PRICE
04-502*	2mm	5/32	1/4	1-1/2	\$12.85
04-508*	3mm	5/16	1/4	1-3/4	\$13.09
04-512*	5mm	1-5/32	1/4	2	\$13.41
04-520	10mm	1-1/4	1/4	2-3/8	\$19.92
04-524	12mm	3/4	1/4	2-1/64	\$19.46
04-528	12mm	1-1/4	1/4	2-3/8	\$19.92
04-532	15mm	3/4	1/4	2-1/4	\$19.60
04-536	15mm	1-1/4	1/4	2-5/8	\$23.17
04-540	16mm	3/4	1/4	2-1/4	\$19.74
04-544	16mm	1-1/4	1/4	2-5/8	\$23.24
04-548	18mm	3/4	1/4	2	\$19.92
04-552	20mm	3/4	1/4	2	\$22.33
12-520	10mm	1-1/4	1/2	2-3/4	\$21.04
12-530	12mm	1-1/4	1/2	2-3/4	\$22.33
12-544	16mm	1-1/4	1/2	2-3/4	\$23.38

*: Solid Carbide

Brick Molding Bit

PART	PROFILE DESIGN	OVERALL DIA. (D)	CARBIDE HEIGHT (h)	SHANK DIA. (A)	OVERALL LENGTH (H)	PRICE
99-460	Brick Molding 1180	3-1/2	1/2	1/2	3	\$92..26

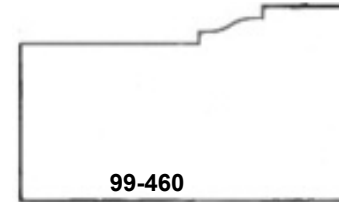

Below are bits that we have in stock and on special sale.

PART #	PRICE	PART #	PRICE	PART #	PRICE	PART #	PRICE
42-106	\$15.30	98-505	\$131.22	99-020	\$40.85	99-218	\$35.00
42-118	\$21.04	98-507	\$131.22	99-021	\$71.72	99-286	\$159.95
54-760	\$35.74	98-509	\$131.22	99-022	\$72.63	99-290	\$99.19
89-102	\$129.58	98-514	\$131.22	99-023	\$49.00	99-291	\$99.19
89-152	\$137.66	99-001	\$64.47	99-024	\$49.00	99-293	\$99.19
90-100	\$260.58	99-002	\$47.39	99-025	\$48.48	99-315	\$53.94
91-104	\$159.67	99-003	\$36.96	99-026	\$34.58	99-318	\$55.41
91-108	\$192.85	99-004	\$40.57	99-028	\$78.37	99-320	\$53.94
93-200	\$396.59	99-005	\$39.94	99-029	\$39.90	99-322	\$53.94
96-100	\$119.98	99-006	\$57.65	99-030	\$46.76	99-482	\$58.21
98-307	\$257.29	99-007	\$68.81	99-041	\$64.96	99-484	\$44.56
98-308	\$257.29	99-008	\$67.87	99-044	\$83.50	98-327	\$66.36
98-309	\$257.29	99-009	\$56.95	99-060	\$53.44	98-328	\$66.36
98-317	\$327.67	99-010	\$59.82	99-061	\$52.43	98-329	\$66.36
98-318	\$327.67	99-011	\$59.82	99-062	\$54.11	BC38MAA-9	\$14.56
98-319	\$327.67	99-019	\$40.88	99-214	\$70.63		

FREUD *Drawings Shown to Scale*

Casing Bits

PART	PROFILE DESIGN	(D)	(h)	(A)	(H)	PRICE
99-465	Casing #356	1-5/8	2-1/2	1/2	4	\$75.29
99-466	Casing #366	1-1/2	1-13/16	1/2	3-9/32	\$58.21
99-467	Casing #376	1-5/8	1-15/16	1/2	3-7/16	\$67.17
99-468	Casing #445	1-1/2	2-7/8	1/2	4-3/8	\$72.91

Base, Cap Bits

PART	PROFILE DESIGN	(D)	(h)	(A)	(H)	PRICE
99-480	Base Cap 1163	1-3/4	1-1/2	1/2	3	\$58.21
99-482	Base Cap 1166	1-11/16	1-1/2	1/2	2-7/8	\$58.21
99-484	Base Molding*	1-11/16	15/32	1/2	2-3/8	\$44.56

Chair Rail Bits

PART	PROFILE DESIGN	(D)	(h)	(A)	(H)	PRICE
99-475	Chair Rail #390	1-11/16	2-3/4	1/2	1-1/4	\$87.75
99-477	Chair #300, upper	2-1/4	1-1/2	1/2	3	\$56.63
99-478	Chair #300, lower	2-3/16	1-13/16	1/2	3-5/16	\$62.30

Beadboard Bit System

PART	DESCRIPTION	(D)	(h)	(A)	(H)	RADIUS (R)	PRICE
20-301	Radius 'V' Groove Bit	1/4	3/16	1/4	1-3/4	1/8	\$16.14
99-472	Beadboard Groove Bit	1-7/8	13/16	1/2	2-7/8	1/8	\$90.69

Table Edge, Handrail Bits

PART	BEARING (D)	Dia. (B)	(h)	LARGE Rad. (R1)	SMALL Rad. (R2)	(A)	(H)	PRICE
99-027	2-19/32	1/2	23/32	1-25/32	13/64	1/2	2-5/8	\$88.27
99-450	2-1/2	1/2	25/32	3/8	15/64	1/2	2-3/4	\$77.98
99-452	2-5/8	1/2	25/32	1-3/32	11/64	1/2	2-3/4	\$91.32

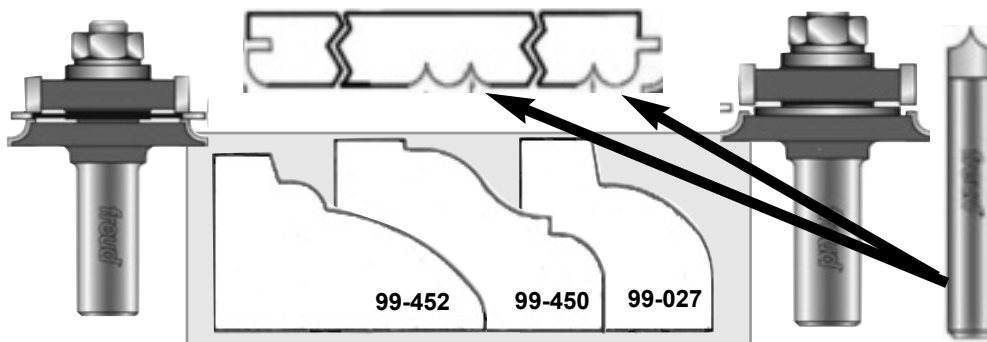
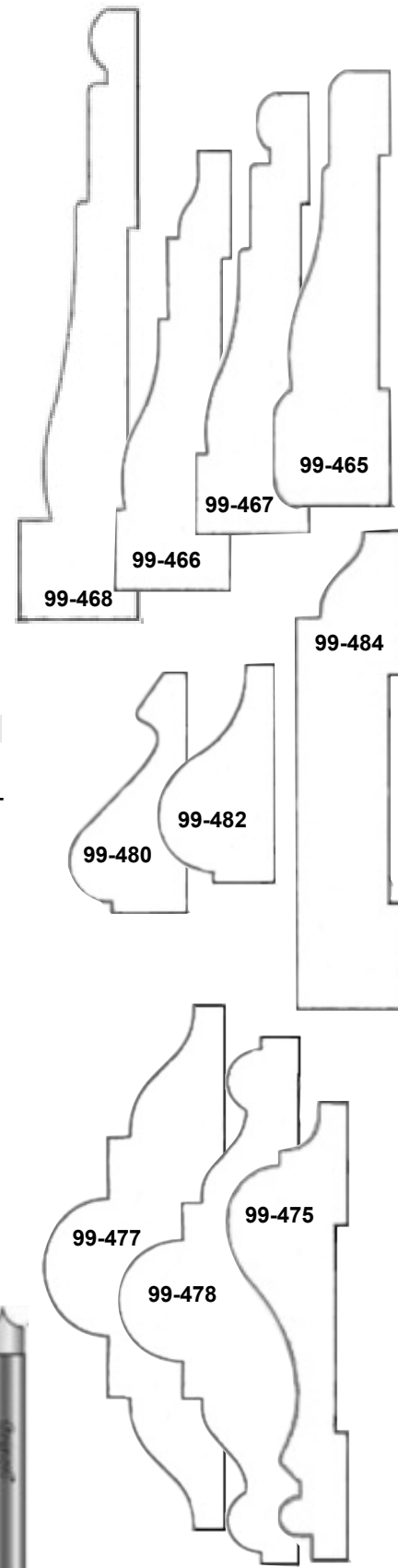

FREUD

One bit produces countless designs for face, corner and crown molding.

Multi-Profile Bits

PART	OVERALL DIA. (D)	SMALL DIA. (n)	CARBIDE HEIGHT (h)	MINOR HEIGHT (m)	(R1) RADIUS	(R2) RADIUS	(R3) RADIUS	SHANK DIA. (A)	OVERALL LENGTH (H)	PRICE
99-PK1	2-5/32	-	1-59/64	-	25/64	5/16	15/64	1/2	4	\$76.51
99-PK2	1-1/4	1-3/32	51/64	5/64	3/8	5/64	-	1/2	2-1/4	\$41.58
99-PK3	1-1/4	1-3/32	29/32	5/64	3/8	5/64	-	1/2	2-7/16	\$41.58
99-PK7	2-33/64	1-7/32	1-51/64	3/32	1/4	3/16	-	1/2	3-1/2	\$108.15
99-PKJ	1-1/2	-	1-7/64	-	7/32	3/16	1/8	1/2	3	\$61.81

Handrail Bits

PART	BEARING (D)	Di. (B)	(h)	LARGE Rad. (R1)	SMALL Rad. (R2)	(A)	(H)	PRICE
99-442	1-3/16	5/8	1-1/2	1	3/8	1/2	3-1/2	\$62.51
99-444	1-3/16	5/8	1-1/2	1/2	3/8	1/2	3-1/2	\$62.51
99-446	1-3/8	1/2	1-1/2	1/8	-	1/2	3-1/4	\$73.01

Face Molding Bits

PART	(D)	(B)	MINOR HEIGHT (h)	(m)	(R1)	(R2)	(A)	(H)	PRICE
99-012	15/16	1/2	1-3/8	3/32	25/32	9/64	1/2	3-1/4	\$70.07
99-013	15/16	1/2	1-3/8	5/32	21/64	9/64	1/2	3-1/4	\$48.23
99-014	15/16	1/2	1-1/2	11/64	25/32	5/32	1/2	3-3/8	\$70.07
99-015	1-1/16	1/2	1-5/8	5/64	5/16	1/8	1/2	3-1/2	\$49.98
99-016	1	1/2	7/8	1/8	45/64	1/8	1/2	2-3/4	\$52.26

Reversible Wainscoting Bit

PART	(D)	(B)	MINOR HEIGHT (h)	(m)	(R)	(A)	(H)	PRICE
99-470	1-1/2	1/2	7/16	3/16	1/4	1/2	2-1/4	\$36.93

New Wide Crown Molding System

PART	PROFILE	(D)	(h)	(A)	(H)	PRICE
99-414	Upper 1	1-5/16	3	1/2	4-7/16	\$72.07
99-415	Lower 2	1-3/8	3-1/16	1/2	4-9/16	\$72.07
99-416	Upper 3	1-13/32	3	1/2	4-7/16	\$72.07
99-417	Lower 4	1-3/8	3-1/16	1/2	4-9/16	\$72.07
99-418	Upper 5	1-1/4	3	1/2	4-7/16	\$72.07
99-419	Lower 6	1-3/8	3-1/16	1/2	4-9/16	\$72.07
99-421	Bevel Cutter	2-3/8	1-3/8	1/2	2-13/16	\$72.07

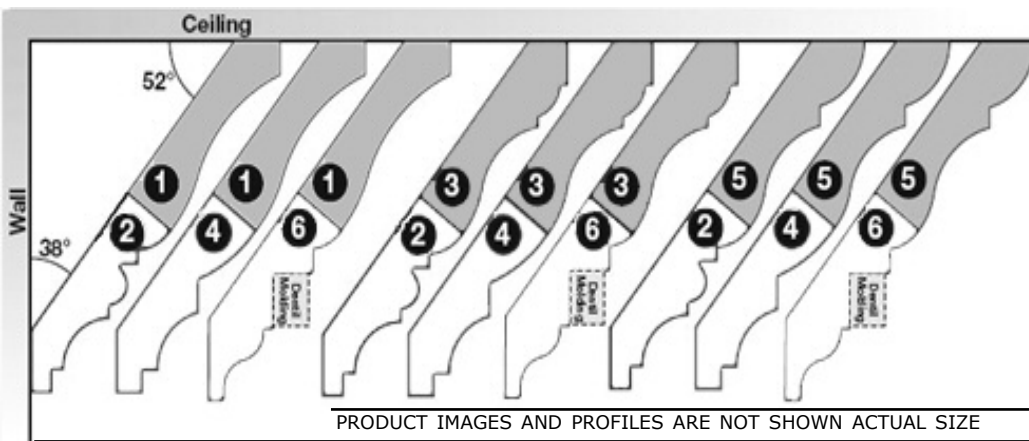
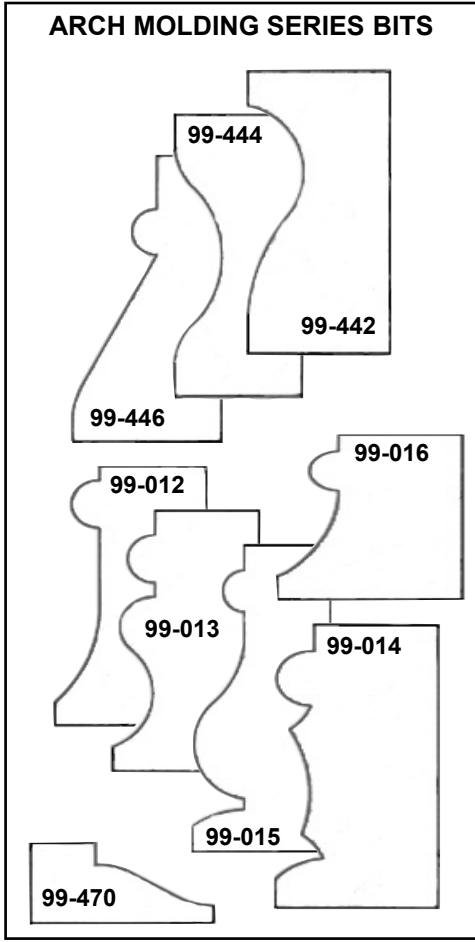

Wide Crown Molding Sets

PART	PROFILE	PRICE
98-505	99-414 & 99-415	\$131.22
98-507	99-414 & 99-417	\$131.22
98-509	99-415 & 99-416	\$131.22
98-514	99-417 & 99-418	\$131.22

FREUD Crown Molding Bits

PART	(D)	(h)	(R1)	(R2)	(d)	(A)	(H)	PRICE
99-402	1-1/4	2-1/4	17/32	7/32	45°	1/2	3-3/4	\$61.81
99-404	1-1/4	2-1/4	43/64	15/32	45°	1/2	3-3/4	\$61.81
99-406	1-1/4	2-1/4	25/64	-	45°	1/2	3-3/4	\$61.81
99-408	1-1/4	2-1/4	1-1/4	-	45°	1/2	3-3/4	\$61.81
99-410	1-1/4	2-1/4	3/16	1/8	10°	1/2	3-3/4	\$61.81

Canoe Joint Bits

PART	(D)	(h)	(R)	(A)	(H)	PRICE
99-017	1-1/2	1/4	1/8	1/2	1-11/16	\$53.73
99-018	1-1/2	3/8	1/8	1/2	1-7/8	\$48.16

Reversible Glue Joint Bit

PART	(D)	(h)	(R)	(d)	(A)	(H)	PRICE
99-031	1-1/2	1-3/16	1-1/4	30°	1/2	2-3/4	\$71.47

Drawer Lock Bits

PART	(D)	(n)	(h)	(m)	(d)	(A)	(H)	PRICE
99-239	1-1/4	1-1/64	1/2	13/64	30°	1/4	1-3/4	\$36.33
99-240	2	1-3/4	33/64	5/32	30°	1/2		\$38.22

Lock Miter Bits

PART	(D)	(h)	(d)	(A)	(H)	PRICE
99-034	2-3/4	1-5/32	45°	1/2	2-5/8	\$95.41
99-035	2-11/64	7/8	45°	1/2	2-3/8	\$83.90
99-043	1-15/32	7/8	22-1/2°	1/2	2-3/8	\$99.19

Wedge Tongue, Groove Bits

PART	(D)	(n)	(h)	(m)	(d)	(A)	(H)	PRICE
99-032	1-1/4	1-1/64	1/2	13/64	30°	1/4	1-3/4	\$69.90
99-033	2	1-3/4	33/64	5/32	30°	1/2	2	\$61.18

Adjustable Tongue, Groove Bit Set

PART	BIT TYPE	(D)	(B)	(h)	(A)	(H)	PRICE
99-036	Tongue Bit	1-3/4	7/8	1-3/16 - 1-11/32	1/2	3-1/4	\$80.01
	Groove Bit	1-3/4	7/8	7/32 - 3/8	1/2	2-11/16	

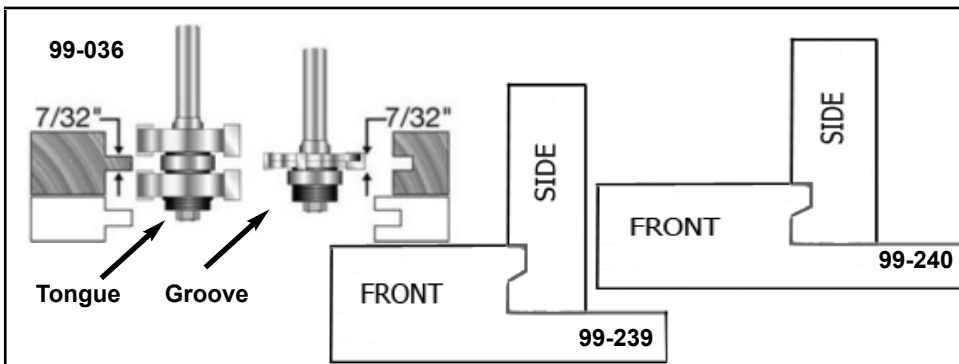

ARCH MOLDING SERIES BITS

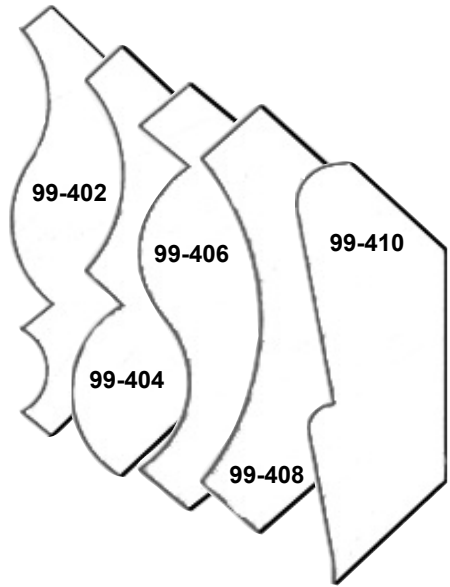

JOINERY BITS

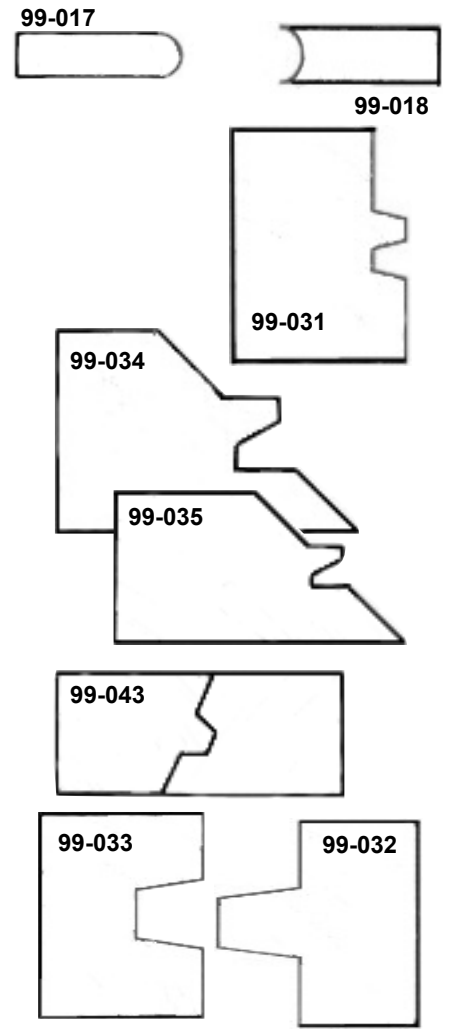

FREUD

JOINERY BITS

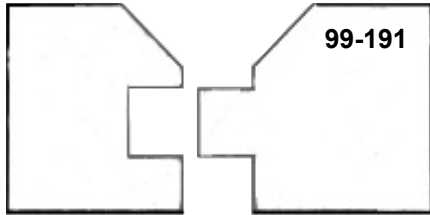
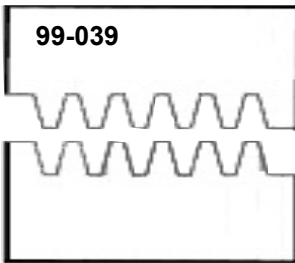
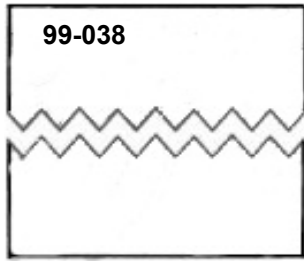

DOOR , WINDOW BITS

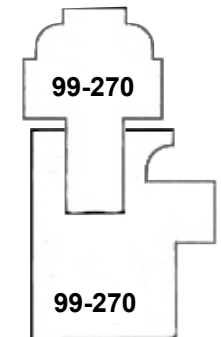
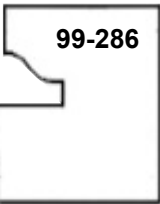
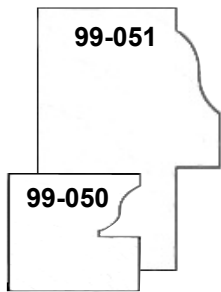
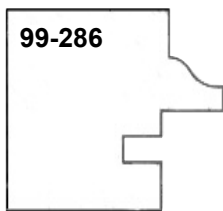

Raised Panel "V" Joint Bit

PART	(D)	(h)	(m)	(d)	(A)	(H)	PRICE
99-038	1-3/8	1-37/64	3/16	80°	1/2	3-1/16	\$93.35

Finger Joint Bit

PART	(D)	CUT DEPTH (C)	(h)	(m)	(A)	(H)	PRICE
99-037	1-3/8	5/16	1-9/16	21/64	1/2	3	\$108.29

Variable Height Finger Joint Bit

PART	(D)	CUT Dia.	(B)	(h)	(A)	(H)	PRICE
99-039	2	5/16	1-3/8 (35mm)	1-9/16	1/2	4-1/4	\$163.49

Replacement Cutters				
ITEM	(D)	BORE Dia.	(h)	PRICE
52-104	2	5/16	7/32	\$20.34
52-108	2	5/16	21/64	\$26.71

"V" Panel Bit Set

PART	(D)	(n)	(h)	MINOR HEIGHT		(d)	(A)	(H)	PRICE
				(m1)	(m2)				
99-191	1-11/64	1-37/64	1-1/8	5/32-5/16	25/64	45°	1/2	3-3/8	\$172.48

Window Sash , Rail Bits

PART	(D)	(B)	(h)	(R1)	(R2)	(A)	(H)	PRICE
99-050	1-1/2	-	39/64	1/16	1/4	1/2	2-1/16	\$50.54
99-051	1-11/32	22mm	1-25/64	17/32	1/4	1/2	3-7/16	\$84.18

Glass Panel Cabinet Door Bit Set

PART	(D)	(B)	(h)	(R1)	(R2)	(A)	(H)	PRICE
99-286	2	16mm	1-3/32	7/32	11/32	1/2	3-1/8	\$159.95

Glass Panel Molding Spine			
ITEM	Color	Roll Length	PRICE
GM005	Fruitwood (medium brown)	25'	\$15.44

Divided Lite Cabinet Door Bit Set

PART	(D)	(B)	(n)	(h)	(R)	(A)	(H)	PRICE
99-270	1-17/32	22mm	1-1/4	1-1/8	1/8	1/2	3-7/16	\$135.31

No Lip Door Edge Bit

PART	(D)	(h)	(R1)	(R2)	(A)	(H)	PRICE
99-063	1-3/4	5/8	9/32	5/64	1/2	2-5/8	\$53.45

FREUD

Recoverable Bead Glass Door Bit Sets

PART	(D)	(B)	(h)	(m)	(R)	(A)	(H)	PRICE
99-280	2-3/8	1-1/4	7/8	1/8	7/32	1/2	3	\$141.05
99-281	2-3/8	1-1/4	7/8	1/8	7/32	1/2	3	\$141.05
99-283	2-3/8	1-1/4	7/8	1/8	15/64	1/2	3	\$141.05

Entry, Interior Door Router System

PART	(D)	(n)	(h)	(m)	(R)	(A)	(H)	PRICE
99-267	1-11/16	1-5/16	11/16	15/64	7/32	1/2	3	\$224.25
99-268	1-11/16	1-19/32	23/32	15/64	13/64	1/2	3	\$224.25
99-269	1-11/16	1-19/32	3/4	15/64	9/32	1/2	3	\$224.25

Entry, Interior Door Bit Set

99-277	1-9/32	25/32	13/16	-	-	1/2	2-11/16	\$271.22
--------	--------	-------	-------	---	---	-----	---------	----------

2+2 Raised Panel Bits

PART	(D)	(n)	(h)	(m)	(R1)	(R2)	(A)	(H)	PRICE
99-510	2-3/4	-	5/8	7/32	35/64	1/8	1/2	2-1/2	\$90.93
99-511	2-3/4	1-1/8	5/8	15/64	-	-	1/2	2-1/2	\$90.93
99-512	2-3/4	1-1/4	5/8	17/64	13/64	-	1/2	2-1/2	\$90.93
99-513*	2-3/4	-	5/8	15/64	7/16	-	1/2	2-1/2	\$90.93
99-515	3-1/2	1-1/4	5/8	5/32	-	-	1/2	2-1/2	\$93.59
99-516	3-1/2	1-1/4	1/2	5/32	-	-	1/2	2-1/2	\$97.62
99-518	3-1/2	-	5/8	5/64	1-1/2	-	1/2	2-1/2	\$93.59
99-519	3-1/2	-	1/2	5/64	1-1/2	-	1/2	2-1/2	\$112.32
99-520	3-1/2	-	5/8	7/32	25/32	5/32	1/2	2-1/2	\$93.59
99-521	3-1/2	-	1/2	-	1-3/16	5/32	1/2	2-1/2	\$84.21
99-522	3-1/2	1-1/4	5/8	-	15/64	-	1/2	2-1/2	\$90.93
99-523	3-1/2	1-1/4	1/2	-	5/32	-	1/2	2-1/2	\$84.21

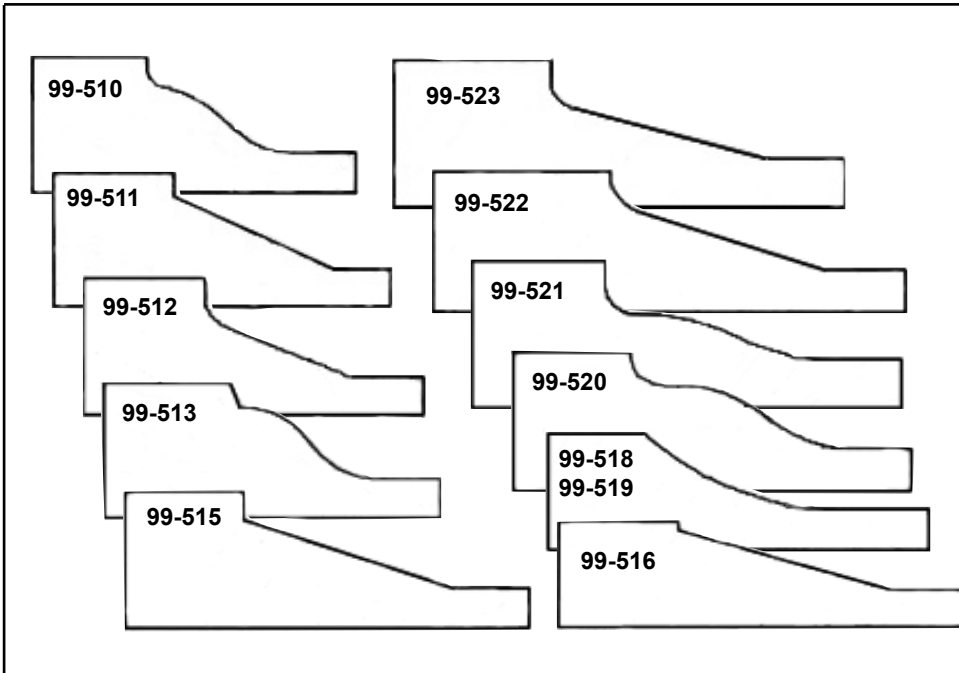

DOOR, WINDOW BITS

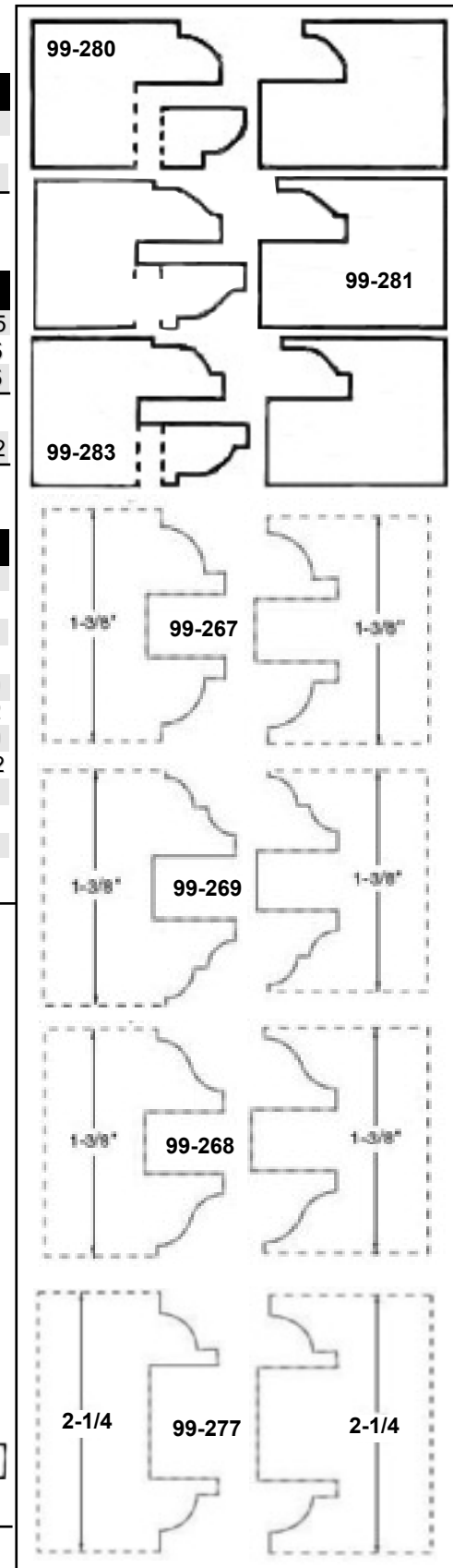

FREUD

2+2 Rased Panel Bits with Backcutters

DOOR , WINDOW BITS

PART	(D)	(h)	(m)	(R1)	(R2)	(A)	(H)	PRICE
99-500	2-19/32	7/8	-	3/4	7/64	1/2	2-51/64	\$112.67
99-566	3-1/2	1	5/32	-	3/16	1/2	3	\$119.56
99-569	3-1/2	1	5/32	1-1/2	3/16	1/2	3	\$119.56
99-571	3-1/2	1	-	1-3/16	5/32	1/2	3	\$119.56

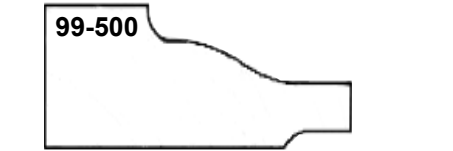
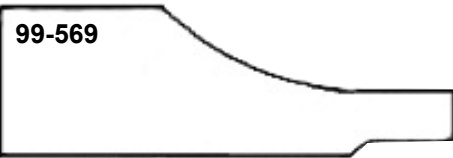

Finger Pull Door Lip Bit

PART	(D)	(n)	(h)	(R1)	(R2)	(d)	(A)	(H)	PRICE
99-064	1-3/4	5/8	1-3/16	9/32	3/32	-	1/2	2-5/8	\$51.77
99-065	2	3/4	1-1/4	1/4	-	25°	1/2	2-3/4	\$65.84

Drawer Front Bit

PART	(D)	(h)	(R)	(A)	(H)	PRICE
99-066	2	9/16	29/32	1/2	2-3/8	\$37.00

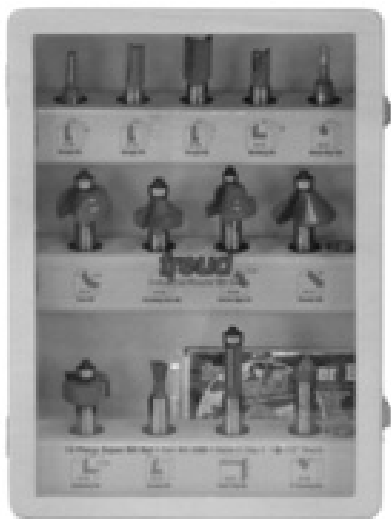
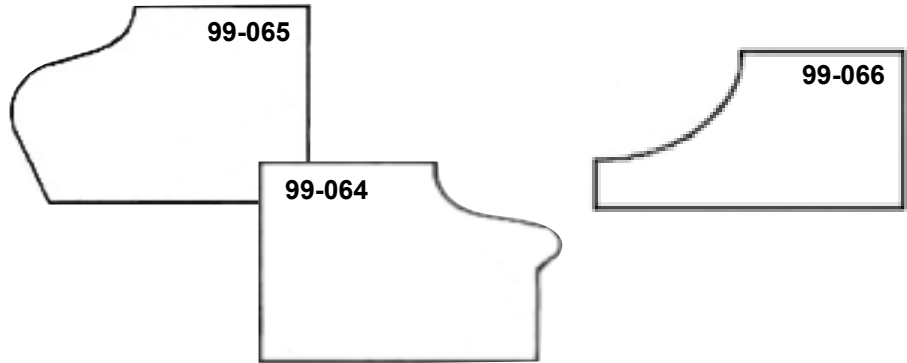

91-100

ROUTER BIT SETS 13 Piece Super Bit Set

BIT TYPE	PRICE
13 Piece Set Item 1 91-100 includes:	
Double Flute Straight Bit (12-100)	
Double Flute Straight Bit (12-116)	
Double Flute Straight Bit (12-152)	
Mortising Bit (16-110)	
Round Nose Bit (18-114)	
"V" Grooving Bit (20-108)	
Dovetail Bit (22-112)	
Cove Bit (30-114)	
Rabbeting Bit (32-102)	
Rounding Over Bit (34-124)	
Roman Ogee Bit (38-106)	
Chamfer Bit (40-114)	
Bearing Flush Trim Bit (42-110)	

All parts above are 1/2" shank

\$260.58

FREUD

ROUTER BIT SETS

3 Piece Door Construction Set

PART	BIT TYPE	PRICE
98-300	Roundover (99-267) Quadra-Cut™ Panel Bit (99-515)	\$312.66
98-302	Roundover (99-267) Quadra-Cut™ Panel Bit (99-518)	\$312.66

5 Piece Cabinet, Molding Bit Sets

PART	BIT TYPE	PRICE
95-100	Reversible Glue Joint Bit (99-031) Quadra-Cut™ Panel Bit (99-510) Multi-Profile Bit (99-PK1) Rail , Stile Bit Set	\$396.59

New Architectural Molding Set

PART	BIT TYPE	PRICE
93-200	Base Cap 1163 (99-480) Casing 1366 (99-466) Crown Bit, upper profile 11 (99-414) Crown Bit, lower profile 14 (99-417) Chair Rail 1300, upper bit (99-477) Chair Rail 1300, lower bit (99-478)	\$396.59

Advanced Cabinet Door Sets

PART	BIT TYPE	PRICE
95-200	Reversible Glue Joint Bit (99-031) Quadra-Cut™ Panel Bit (99-510) Drawer Lock Bit (99-240) Rail , Stile Bit Set	\$283.19



All Router Bit Sets listed in this section are packaged in an attractive wooden storage box with plastic covering and a template diagram on the front.

BALL BEARING REPLACEMENTS for ROUTER BIT SETS

Ball Bearings

PART	INSIDE DIA.	BEARING DIA.	BEARING HEIGHT	PRICE
62-100	1/8	3/8	5/32	\$5.29
62-102	3/16	3/8	1/8	\$6.41
62-103	1/4	1/2	3/16	\$6.41
62-104	3/16	1/2	3/16	\$5.08
62-105	10mm	9mm	7mm	\$9.80
62-106	1/4	3/4	9/32	\$6.41
62-107	5/16	7/8	9/32	\$6.86
62-108	8mm	22mm	7mm	\$5.29
62-109	15mm	35mm	11mm	\$3.01
62-110	3/16	3/4	1/4	\$6.41
62-111	15mm	32mm	9mm	\$6.41
62-112	1/4	5/8	3/16	\$5.99
62-113	3/16	5/8	3/16	\$5.99
62-114	1/2	1-1/8	5/16	\$6.41
62-116	1/2	1-3/8	7/16	\$6.86
62-118	10mm	26mm	8mm	\$6.41
62-120	5/16	1	10mm	\$11.27
62-121	5/16	1-1/4	10mm	\$11.48
62-122	5/16	1-1/2	10mm	\$11.83
62-124	5/16	26mm	7mm	\$11.20
62-128	5/16	30mm	7mm	\$11.20
62-136	17mm	2	10mm	\$18.17
62-139	1/2	1-1/2	5/16	\$14.98
62-144	3/16	3/4	12mm	\$6.41
62-146	3/16	7/8	12mm	\$5.99
62-148	3/16	1-1/8	12mm	\$6.13
62-150	3/16	1-3/8	12mm	\$6.41

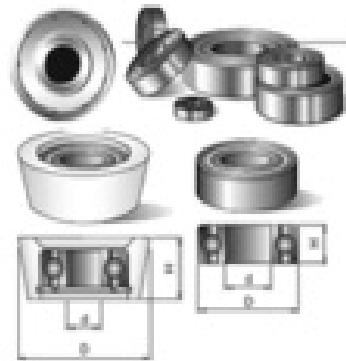

Finally, Unlimited Cabinet Door Possibilities...

freud[®]
Precisely the best.



...with Freud's **NEW** Premier Adjustable Rail & Stile Bit System

This New System Offers Unmatched Versatility in Cabinet Door Making with



Extended Tenons

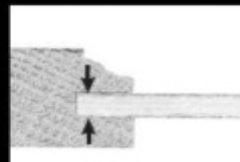

Adjustable Grooves



Varying Stock Thicknesses



Glass/Screen Panels



Double Sided Profiles

FREUD

Unlimited Possibilities in Cabinet Door Making

2 pc. Premier Adjustable Rail and Stile Cutter Sets



The 2 piece Premier Adjustable Rail and Stile set allows you to create doors in a range of thicknesses and sizes with stub or extended tenons, plus variable groove thicknesses for panels. This set includes a wrench for adjusting the bits.

PART	BIT TYPE	PRICE
99-760	(1) Rail , (1) Stile Bit Round Over	\$123.90
99-761	(1) Rail , (1) Stile Bit Ogee	\$128.31
99-763	(1) Rail , (1) Stile Bit Round Over Bead	\$124.01
99-764	(1) Rail , (1) Stile Bit Bevel	\$124.01

3 pc. Premier Adjustable Cabinet Door Sets



This 3 piece cabinet door set includes the 2 piece Premier Adjustable Rail , Stile set plus an exclusive Quadra-cut Raised Panel Bit (either with or without a backcutter). There are 11 sets to choose from with the Adjustable Rail , Stile sets in either the Round over or Ogee profiles.

PART	BIT TYPE	PRICE
97-150	Round Over (99-760) Bevel (99-515)	\$201.60
97-152	Round Over (99-760) Cove (99-518)	\$201.60
97-154	Round Over (99-760) Ogee (99-520)	\$201.60
97-156	Round Over (99-760) Bevel w/Backcutter (99-566)	\$221.24
97-158	Round Over (99-760) Cove w/Backcutter (99-569)	\$221.24
97-250	Ogee (99-761) Bevel (99-515)	\$201.60
97-252	Ogee (99-761) Cove (99-518)	\$201.60
97-254	Ogee (99-761) Ogee (99-520)	\$201.60
97-258	Ogee (99-761) Cove w/Backcutter (99-569)	\$228.17
97-260	Ogee (99-761) Ogee w/Backcutter (99-571)	\$228.17
97-276	Ogee (99-761) Roman Ogee (99-513)	\$196.04

5 pc. Premier Adjustable Cabinet Door Sets



This 5 piece cabinet door set includes the 2 piece Premier Adjustable Rail , Stile set plus an exclusive Quadra-cut Raised Panel Bit, Door Lip Bit, and a Reversible Glue Joint Bit.

PART	BIT TYPE	PRICE
94-150	Rail , Stile Bits (2) Panel Bit (1) Reversible Glue Joint Bit (1) Door Lip Bit (1)	Round Over Ogee \$295.93

Add These Optional Cutters To Expand Your Possibilities

Optional Glass/Screen Panel Cutter



With the addition of this optional cutter to your basic 2 piece Premier Adjustable Rail , Stile set, you have the ability to create any shape and style of glass panel door with either traditional stub tenons or extended tenons for extra strength and durability. This set also gives you the capability to make screen doors.



PART	BIT TYPE	PRICE
54-760	Add-on cutter for making glass/screen panel doors	\$35.74

Optional Double Sided Profile Cutter



By adding this optional cutter set to your basic 2 piece Premier Adjustable Rail , Stile set, you can make double sided decorative profile doors in thicker stock. Ideal for woodworking projects such as media centers, libraries, and fine furniture.

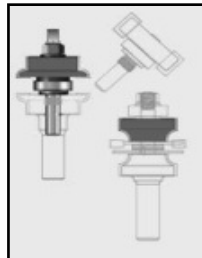

PART	BIT TYPE	PRICE
99-860	Rail Bit Cutter RoundOver Stile Bit Cutter RoundOver	\$91.74
99-861	Rail Bit Cutter Ogee Stile Bit Cutter Ogee	\$91.74
99-863	Rail Bit Cutter Round Over Bead Stile Bit Cutter Round Over Bead	\$91.74
99-864	Rail Bit Cutter Bevel Stile Bit Cutter Bevel	\$91.74

