

# PORTER CABLE®

Quality Tools Since 1906®







## Table of Contents

### **WOODWORKING** **2**

Laminate Trimmers	3
Routers	4
Router Accessories	7
Sanders	9
Polisher	12
Stationary & Specialty	13
Dovetail & Joinery	14

### **CONSTRUCTION -- CORDLESS** **21**

12V Max <sup>†</sup> Tools	24
18V Tools	25
18V Combo Kits	27
18V Bare Tools	29
20V MAX <sup>‡</sup> Tools	33
Batteries & Chargers	34

### **CONSTRUCTION -- CORDED** **35**

Oscillating Multi-Tool	35
Circular Saws	36
Reciprocating Saws	37
Jig Saw	38
Drills / Hammerdrills	38
Planer	39
Heat Gun	39
Grinders	39

### **FASTENING** **40**

Compressors	41
Fasteners	42
Nailers	44
Combo Kits	48

<sup>†</sup> Maximum initial battery voltage (measured without a workload) is 12 volts. Nominal voltage is 10.8.  
<sup>‡</sup> Maximum initial battery voltage (measured without a workload) is 20 volts. Nominal voltage is 18.

# PORTER CABLE®

## WOODWORKING TOOLS



# LAMINATE TRIMMERS

## LAMINATE TRIMMERS

**7310** Laminate Trimmer

**7312** Offset Laminate Trimmer

**7319** Tilt-Base Laminate Trimmer

### SHARED FEATURES

- Durable 5.6 Amp, 30,000 RPM Motor
- Perfect for Most Trimming, Small Edge Forming & Hinge Routing Applications
- Ergonomics Allow for Comfortable, Single Handed Control
- Precision Cast Aluminum Base Provides Long Term Durability
- Sealed Ball Bearing Construction Enhances Tool Durability
- 1/4" Collet



7310

7319

7312

MODEL #	UNIQUE TOOL FEATURES
7310	<ul style="list-style-type: none"> <li>• Includes Standard Fixed Base; MICRO-SET™ Adjustment Knob Enables Quick &amp; Accurate Bit-Depth Setting</li> <li>• Spindle Lock Feature Allows for Single Wrench Bit Changes</li> <li>• Base Design Allows for Excellent Bit Visibility</li> </ul>
7312	<ul style="list-style-type: none"> <li>• Includes Offset Base; Offset Base Enables Backsplash Trimming, Scribing to Wall &amp; Trimming of 90 Degree Corners</li> </ul>
7319	<ul style="list-style-type: none"> <li>• Includes Tilt Base; Adjusts Backwards 30 Degrees &amp; Forward 45 Degrees for Angled Cuts</li> </ul>

**97310** Laminate Trimmer Kit

**97311** Deluxe Laminate Trimmer Kit

### SHARED FEATURES

- Durable 5.6 Amp, 30,000 RPM Motor
- Ergonomics Allow for Comfortable & Assured, Single Handed Control
- MICRO-SET™ Adjustment Knob Enables Quick & Accurate Bit Depth Setting
- Spindle Lock Feature Allows for Single Wrench Bit Changes
- Precision Cast Aluminum Base & Sealed Ball Bearing Construction for Durability
- 1/4" Collet
- Includes: Trimmer Motor #7301, Standard Trimmer Base, Offset Trimmer Base, Tilt Trimmer Base, Edge Guide, Wrenches, Carrying Case with Additional Space for Bit Storage



97310

97311

MODEL #	UNIQUE TOOL FEATURES
97311	<ul style="list-style-type: none"> <li>• Includes Underscribe Attachment for Joining Laminate</li> </ul>

### ACCESSORIES



7301 Replacement Motor;  
5.6 amps 30,000 RPM



7309 Standard Base for  
7310 Laminate Trimmer



7311 Offset Base for 7310 Laminate  
Trimmer or 7312 Replacement



7318 Tilt Base for 7310 Laminate  
Trimmer or 7319 Replacement Base

## COMPACT ROUTERS

**450** 1-1/4 HP Max Torque Compact Router

**450PK** 1-1/4 HP Max Torque Compact Router Combo Kit

### SHARED FEATURES

- Ergonomically Designed to Allow for Comfortable & Assured, Single Handed Control
- Durable 1-1/4 Hp Motor Delivers the Power to Meet the Toughest Applications
- Soft-Starting Motor Features Full-Time Electronic Feedback That Maintains Motor Speed Through the Cut
- Adjustment Ring Enables Controlled Bit Depth Changes to within 1/64"
- Depth Ring & Clamping Mechanism Combine to Ensure Motor Remains Locked in Position
- Large, Low-Pressure Spindle Lock Button Allows for Comfortable, Single Wrench Bit Changes
- Aluminum Motor Housing & Base Construction Provides Long Term Durability
- Large 4" Diameter Sub-Base Accepts Universal Template Guides
- Extended 8-Slot 1/4" Collet Maximizes Surface Contact with Router Bit Shank for a Tighter Grip



MODEL #	UNIQUE TOOL FEATURES
450	<ul style="list-style-type: none"> <li>• Fixed Base Router</li> </ul>
450PK	<ul style="list-style-type: none"> <li>• Fixed &amp; Plunge Base Combo Kit; Large Plunge Base Platform Provides Added Stability for Heavier Applications &amp; Sub-Base Accepts Universal Template Guides</li> </ul>

**9690LR** 1-3/4 HP\* Router Kit

### FEATURES

- 11 Amp Motor Producing 1-3/4 Peak Hp
- 27,500 RPM Single Speed Motor
- Cam Lock Lever Enables Simple Coarse Height Adjustments & Motor Release
- Micrometer Depth Adjustor Accurate to 1/128"
- Dust-Sealed Switch & Sealed Ball Bearing Construction Enhance Tool Durability
- Auto-Release Collet System Allows for Easy Bit Removal After use
- Collets Included to Accept 1/4" & 1/2" Shank Bits
- Under Table Stop Prevents Motor from Inadvertently Rotating Out of Base
- Overmolded Grips for Greater Comfort in Extended use
- Kit Box Included



**690LR** 1-3/4 HP\* Router

### FEATURES

- 11 Amp Motor Producing 1-3/4 Peak Hp
- Cam Lock Lever Enables Simple Coarse Height Adjustments & Motor Release
- Micrometer Depth Adjustor Accurate to 1/128"
- Dust-Sealed Switch & Sealed Ball Bearing Construction Enhance Tool Durability
- Precision Machined Aluminum Motor Housing & Base
- Auto-Release Collet System Enables Simple Bit Removal
- Collets Included to Accept 1/4" & 1/2" Shank Bits
- Under the Table Stop Prevents Motor from Inadvertently Rotating Out of Base
- Overmolded Rubber Handles Provide a Comfortable & Secure Grip
- Includes: Router Motor, Fixed Base, 1/4" & 1/2" Collets, Collet Wrenches
- 27,500 RPM Single Speed Motor



### ACCESSORIES



Model 1001  
Standard Fixed Base

Model 6911  
D-handle base

Model 6931  
Plunge base for 690  
series routers



Model 6902  
1-3/4 HP (Maximum  
Motor HP) single speed  
replacement motor for 690  
series routers



Model 6902VS  
1-3/4 HP (Maximum  
Motor HP) variable speed  
replacement motor for 690  
series routers

## 691 1-3/4 HP\* D-Handle Router

### FEATURES

- 11 Amp, 27,500 RPM Motor Producing 1-3/4 Peak Hp
- D-Handle Allows for both Single Hand Gripping & Enhanced Router Control When Used in Conjunction with Standard Knob
- D-Handle Incorporates Trigger Switch with 'Lock-on' Feature
- Precision Machined Aluminum Motor Housing & Base
- Dust-Sealed Switch & Sealed Ball Bearing Construction Enhance Tool Durability
- Auto-Release Collet System Enables Simple Bit Removal
- Collets Included to Accept 1/4" & 1/2" Shank Bits
- Recommended for use with the 4200 Series Dovetail Jigs & OMNIJIG® Joinery System
- Includes: Router Motor, Fixed Base, 1/4" & 1/2" Collets, Collet Wrenches



## 693LRPK 1-3/4 HP\* Multi-Base Router Kit

### FEATURES

- 11 Amp Motor Producing 1-3/4 Peak Hp
- Cam Lock Lever Enables Simple Coarse Height Adjustments & Motor Release (Fixed Base)
- Micrometer Depth Adjustor Accurate to 1/128"
- Motor Transitions Quickly & Easily Between Fixed & Plunge Base
- 6-Position Adjustable Turret Allows for Stepped Plunge Cuts
- Precision Machined Aluminum Motor Housing & Base
- Dust-Sealed Switch & Sealed Ball Bearing Construction Enhance Tool Durability
- Auto-Release Collet System Enables Simple Bit Removal
- Collets Included to Accept 1/4" & 1/2" Shank Bits
- Under Table Stop Prevents Motor from Inadvertently Rotating Out of Base
- 27,500 RPM Single Speed Motor



## 892 2-1/4 HP\* Fixed Base Router Kit

### FEATURES

- Soft-Starting, 12 Amp Motor Features Full-Time Electronic Feedback That Maintains Motor Speed Through the Toughest Applications
- Variable-Speed Control Feature (10,000-23,000 RPM) Enables Bit Speed to be Optimized for Changing Applications
- Release the Motor, Adjust Bit Height, & Clamp the Motor from Above the Router Table with 3/16" Hex Socket (Sold Separately) or Model # 75301 Kit (Sold Separately)
- Overmolded Rubber Handles Provide a Comfortable & Secure Grip
- Durable Latch Lever Enables Quick & Simple Coarse Depth Adjustments & Motor Release for Transition Between Bases
- Rack & Pinion Adjustment Provides Fine Depth Settings to 1/128"
- Collets Included to Accept 1/4" & 1/2" Shank Bits
- Motor Transitions Quickly Between Fixed Base (Included), Plunge Base (8931), & Traditional Spiral Down Bases (690-Series Routers)



### ACCESSORIES



8911 GripVac™  
Handle Attachment



75301 Height  
Adjuster



8931 Plunge Base  
for 890 Series  
Routers

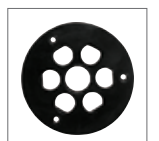

42186 Black,  
Phenolic Base

**893PK 2-1/4 HP\* Multi-Base Router Kit**

**894PK 2-1/4 HP\* Multi-Base Router Kit with GRIPVAC™ Attachment**

**895PK 2-1/4 HP\* Multi-Base Router Kit with Router Table Height Adjuster**

**SHARED FEATURES**

- Soft-Starting, 12 Amp Motor Featuring Full-Time Electronic Feedback That Maintains Motor Speed Through the Toughest Applications
- Variable-Speed Control Feature (10,000-23,000 RPM) Enables Bit Speed to be Optimized for Changing Applications
- Motor Transitions Quickly Between Fixed Base (Included), Plunge Base (Included), & Traditional Spiral Down Bases (690 Series)
- Overmolded Rubber Handles Provide a Comfortable & Secure Grip
- Plunge Base Offers Through-the-Column Dust Collection for Efficient Dust Removal & Improved Bit & Cut-Line Visibility
- Dual-Position Switch Allows User to Cut Power While Maintaining Control of the Router
- Rack & Pinion Adjustment Provides Fine Depth Settings to 1/128" (Fixed Base Only)
- 6-Position Adjustable Turret Enables Stepped or Repeated Plunge Cuts
- Clear LEXAN® Sub-Base Provides Improved Durability & Bit Visibility
- Flat Side on Plunge Base Allows User to Work in Tighter Spaces & Provides a Straight Reference Point
- Collets Included to Accept 1/4" & 1/2" Shank Bits

893PK



894PK



895PK



MODEL #	UNIQUE TOOL FEATURES
893PK	• Includes Standard Fixed Base & Plunge Base
894PK	• Includes GRIPVAC™ Handle With Fixed Base; GRIPVAC™ Handle Allows for Both Single Hand Gripping & Enhanced Router Control When Used in Conjunction With Standard Knob • GRIPVAC™ Handle Includes Integrated Dust Collection
895PK	• Includes Router Table Height Adjuster

**7518 3-1/4 HP\* Five Speed Router**

**7519 3-1/4 HP\* Single Speed Router**

**SHARED FEATURES**

- 15 Amp Motor Provides the Power & Durability Necessary for the Toughest Applications
- Auto-Release Collet System Allows for Easy Bit Removal
- Precision Machined Aluminum Motor Housing & Base
- Sealed Ball Bearing Construction Enhances Tool Durability
- Base Includes Large Integrated Cast Handles for Enhanced Stability & Durability



7518



7519

MODEL #	UNIQUE TOOL FEATURES
7518	• Versatile, Electronic Five-Speed Soft Starting Motor with 10,000, 13,000, 16,000, 19,000 & 21,000 RPM Settings Accommodates Various Router Bit Cutting Diameters & Applications
7519	• 21,000 RPM Single Speed Motor

**ACCESSORIES**



75182 3-1/4 HP (Maximum Motor HP) Five Speed Replacement Motor for Router Model 7518



75361 Fixed Base Replacement for Router Models 7518 and 7519

# ROUTERS & ACCESSORIES

7538

**3-1/4 HP\* Five Speed Plunge Router**

7539

**3-1/4 HP\* Single Speed Plunge Router**

#### SHARED FEATURES

- 15 Amp Motor Provides the Power & Durability Necessary for the Toughest Applications
- Auto-Release Collet System Enables Simple Bit Removal
- Depth Rod & 6 Position Adjustable Turret Enables Stepped or Repeated Plunge Cuts
- 3" Plunge Range
- Precision Machined Aluminum Motor Housing & Base
- Handle Incorporates Trigger Switch with Lock-on Feature
- Large Handles Enhance User Control



7538



7539

#### MODEL #

#### UNIQUE TOOL FEATURES

7538

- Single Speed 21,000 RPM Soft Starting Motor

7539

- Versatile, Electronic Five-Speed Motor With 10,000, 13,000, 16,000, 19,000 & 21,000 RPM Settings Accommodates Various Router Bit Cutting Diameters & Applications

## ROUTER ACCESSORIES

59370

**Door Hinge Template**

#### FEATURES

- Used to Rout both Door & Door Frame Hinges for a Complete Door Hanging Solution
- Accommodates Doors of Various Thickness - 1-3/8", 1-3/4", 2", 2-1/4", 2-1/2"
- Accommodates 8 Hinge Sizes from 2-1/2" to 6" Inclusive, in 1/2" Increments
- Quick-Adjust Ratcheting Router Bit Guides Accommodate 1/4", 5/8" Radius & Square Cornered Hinges (42234 Corner Chisel Sold Separately)
- Extended Template Platform for Improved Router Stability
- Double-Headed Nails Ensure Easy Removal from Door & Frame
- Positive Placement Lock-in Pins Enable Quick & Secure Placement of the Template to the Door & Jamb
- Standard Equipment: Door Hinge Template, (2) Ratcheting Router Bit Guides, (4) Positive Placement Lock-in Pins with 2 Spares, (2) Double-Headed Nails, High-Speed Steel Bearing Guided Bit, Instruction Manual, & Quick-Reference Instruction Card
- Net Weight: 0.52 lbs



59375

**Strike & Latch Template**

#### FEATURES

- Accommodates Doors of Various Thickness - 1-3/8", 1-3/4", 2", 2-1/4", 2-1/2"
- Double Window Design with Adjustable Width Inserts Accommodates 1" & 1-1/8" Latch Plate Widths & Alternate Strike Plate Designs
- Accommodates both 2-1/4" & 2-3/4" Strike Plate Sizes
- Template Center Marks Enable Quick & Simple Alignment
- Extended Template Platform for Improved Router Stability
- Double-Headed Nails Ensure Easy Removal from Door & Frame
- Positive Placement Lock-in Pins Enable Quick & Secure Placement of the Template to the Door & Frame
- Standard Equipment: Strike & Latch Template with 3 Insert Pieces, (4) Positive Placement Lock-in Pins with 2 Spares, (2) Double-Headed Nails, High-Speed Steel Bearing Guided Bit, Instruction Manual, & Quick-Reference Guide Card
- Net Weight: 0.52 lbs



## ROUTER ACCESSORIES CONT.

### 59381 Hinge Butt Template Kit

#### FEATURES

- Provides the Capacity to Hang both 3 & 4 Hinge Doors
- 3 Hinge Template Set up Enables the Routing of Hinges for Doors & Frames Between 6' & 7' in Height
- 4 Hinge Template Set up Enables the Routing of Hinges on Doors & Frames Between 7' & 8' in Height
- Accommodates Hinge Sizes from 3" to 6" in 1/2" Increments
- Accommodates Door Thicknesses of 1-3/8", 1-3/4", 2", 2-1/4" & 2-1/2"
- End Gages Enable the Simple Setting of the Distance from Template to Top & Bottom of Door
- Corner Chisel Accommodates Square Hinge Corners
- Carbide Tipped Router Bit & Template Guide Included for 1/4" Radius Hinges
- 5/8" & 5/16" Radius Hinge Corners Can be Accommodated with the use of Bits & Template Guides (Sold Separately)
- All Metal Construction Provides Long Term Durability
- Standard Equipment: 4 Metal Hinge Templates, (3) Short Rails, (2) Long Rails, Carbide Tipped Router Bit, Template Guide, Locknut, Corner Chisel, (2) Pairs of End Gages, (8) Small Thumb Screws, (6) Large Thumb Screws, Hex Key, Operating Manual with Instructions, & Carrying Case
- Net Weight: 15.0 lbs

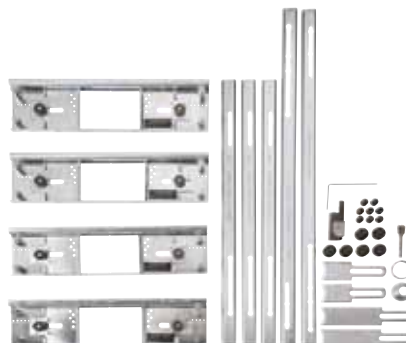

### Additional Accessories and Replacement Parts

MODEL #	CUT WIDTH	TYPE	USE WITH TEMPLATE GUIDE NO.	HINGE TYPE
43437PC	1/2"	Carbide	42042*	Square or 1/4" Corner Radius
43440PC	5/8"	Carbide	42039	5/16" Corner Radius
43442PC	1-1/4"	Carbide	42048	5/8" Corner Radius

### 511 Cylindrical Lock Boring Jig

#### FEATURES

- Quick, Easy Way to Install Cylindrical Door Locks
- Jig Locates Quickly for Either 2-3/8" or 2-3/4" Backsets
- All Holes Drilled in a Single Set-up
- Adjustable for Door Thicknesses Between 1-5/16" & 2-1/8"
- Includes Strike Locator for Accurate Placement of Jamb Mortise
- Instruction Sheet Included on Kitbox Lid for Easy Reference
- Lock Boring Jig, 1" Boring Bit, 2-1/8" Boring Bit, Full-up Strike Mortiser, Latch Mortiser, Maximum Security Mortiser, Striker Locator, Quick-Change Drill Adapter, & Storage Case



### 513 Heavy-Duty Lock Mortiser

#### FEATURES

- 11 Amp, 27,500 RPM Motor Producing 1-3/4 Peak Hp
- Quickly & Accurately Cuts Mortises for Box Locks
- Particularly Useful in Entry Door Lock Installations
- Cuts Mortises up to 7" Long, 1-1/4" Wide & 4-3/4" Deep
- Simple to Set-up & Locate to Door
- Automatically Centers Cutter on Door Edge
- Adjustable Height Rod Allows for Repetitive Mortise Cuts
- Durable Steel & Alloy Construction
- Mortising Machine with 1-3/4 Peak Hp Motor, Height Rod Assembly (4 Rods, 1 Stop, & 1 Nut), Wrench, 3/4" Bit, 1" Bit, Allen Wrench, & Operating Manual



### Mortise Bits

MODEL #	CUT WIDTH	MODEL #	CUT WIDTH	MODEL #	CUT WIDTH
43698PC	5/8"	43701PC	7/8"	43699PC	1-1/8"
43703PC	3/4"	43702PC	15/16"	43709PC	3/8"
43700PC	13/16"	43704PC	1"	43745PC	1-1/4"

### 517 Heavy-Duty Lock Mortiser Template

#### FEATURES

- Used to Quickly Rout Lock Faces on Door After the Mortise for the Box Lock Itself has Been Completed
- Self-Centers & Self-Bevels Automatically
- Recommended for use in Conjunction with 513 Heavy-Duty Lock Mortiser
- 1-1/2" X 8-1/2" Mortising Capacity
- Solid & Durable Steel Construction



# ROUTER ACCESSORIES & SANDERS

## 698 Router Table

### FEATURES

- Large 19-3/4" x 16-3/4" Machined Aluminum Table with Cast-In Lip to Support Extensions
- 3/4" Miter Gauge Slot
- Multiple Starting Pin Locations
- Quick-Adjust Split-Fence Design with Independently Adjustable Halves
- Large 3-5/8" Table Hole Size Allows Use of 3-1/2" Diameter Router Bits
- Dust Collection Hood Sized for 2-1/2" Hose
- 12-7/8" Leg Height Allows Use of 1-1/2 to 3-1/4 HP Routers
- Standard Equipment: Shaper Table #698, 3/4" Miter Gauge #6970 & Operating Manual



## RANDOM ORBIT SANDERS

### 382 5" Random Orbit Sander

### FEATURES

- Provides Maximum Sanding Speed for Smooth Finishes
- Controlled Finishing System Maintains Controllable Pad Speed & Minimizes Gouging During Start up
- Dual-Plane Counter-Balanced Fan Reduces User Fatigue
- Dust-Sealed Switch Protects Against Dust Ingestion for Longer Switch Life
- Sealed 100% Ball-Bearing Construction
- Accepts 5", 8-Hole Hook & Loop Paper



### 390 5" Low Profile Random Orbit Sander with Hook & Loop Pad

### 390K 5" Low Profile Random Orbit Sander Kit with Hook & Loop Pad

### 394 5" Low Profile Random Orbit Sander with Dust Collection, PSA Pad

### SHARED FEATURES

- 3.5 Amp EnduraTech Motor for Increased Performance & Durability
- Electronic Load Control for 42% Faster Material Removal
- EnduraTech Motor Technology has 71% Fewer Wear Components for 5-10 Times Longer Motor Life
- Electronic Motor Brake Reduces Spin-Down Time by 73% for Increased Productivity
- Mechanical Pad Brake Reduces Free-Spin to Virtually Eliminate Gouging
- Low Profile Design Reduces Sander Height by 31% for Better Control & Finish
- Variable-Speed Dial, 7,500 - 12,000 OPM, Optimizes Removal Rate on a Variety of Materials
- Optimized Ergonomics with Rubber Grip for Comfort & Control
- Integral Dust Port Accepts 1" & 1-1/2" Vacuum Hoses for Optimal Dust Collection
- 3/32" Orbit Diameter



### MODEL #

### UNIQUE TOOL FEATURES

390K

- Includes Kit Box

394

- Dust Collection

## 1/4 SHEET SANDERS

### 330 SPEED-BLOC® 1/4 Sheet Finishing Sander

#### FEATURES

- Comfortable, Easy-Grip Outer Housing for Hours of use without Fatigue
- Solid Metal Frame for Precision Seating & Alignment of Bearings, Motor, & Fan, Providing for Maximum Trouble-Free Tool Life
- Rubber Posts Isolate Your Hand from Vibration While Enabling Full Sanding Action & Efficiency on the Work
- 100% Ball Bearings
- 14,000 OPM Pad Speed with 5/64" Orbit
- Accepts Pre-Cut Adhesive or Self Cut Standard Paper with Metal Stamp
- Standard Equipment: Sander, Abrasive Sheet, Clamp Tool #846372, & Operating Manual



### 380 1/4 Sheet Orbital Finish Sander

#### FEATURES

- 2 Amp Motor Moves at 13,500 OPM, Providing a Superior Finish
- Dual Plane, Counter-Balanced Low-Vibration Design Reduces User Fatigue
- Dust-Sealed Switch Protects Against Dust Ingestion for Longer Switch Life
- Sealed 100% Ball-Bearing Construction



## RIGHT ANGLE RANDOM ORBIT SANDERS

### 7345 5" Variable-Speed Random Orbit Sander

### 7346 6" Variable-Speed Random Orbit Sander

### 7346SP 6" Variable-Speed Random Orbit Sander with Polishing Pad

#### SHARED FEATURES

- 4.5 Amp, AC Only
- Electronic Variable-Speed Dial 2,500-6,800 OPM
- Random Orbit, Swirl-Free Sanding/Polishing Action
- Accepts 5/16 - 24 Spindle Thread Accessories
- Features Two-Position (Left or Right) Removable Side Handle for Greater Comfort & Control
- Compact Lightweight Design - 5.5 lbs
- 100% Ball & Roller Bearing Construction

MODEL #	UNIQUE TOOL FEATURES
7346	• Includes 6" Proprietary Counter Balance for Use With 6" Sanding/Polishing Pad
7345	• Includes 5" Proprietary Counter Balance for Use With 5" Sanding/Polishing Pad
7346SP	• Includes 6" Proprietary Counter Balance for Use With 6" Sanding/Polishing Pad



7345



7346



7346SP

# SANDERS & POLISHERS

## BELT SANDERS

### 352VS 3" x 21" Variable-Speed Sander

#### FEATURES

- 8 Amp Motor, AC Only
- Variable-Speed Dial 850-1,300 SFPM
- Belt & Gear Drive for Professional Durability
- Designed for Flush Sanding up to Vertical Surfaces
- Dust Bag Swivels 360 Degrees
- Fingertip Belt-Tracking Knob



### 360 3" x 24" Sander

### 360VS 3" x 24" Variable-Speed Sander

### 362 4" x 24" Sander

### 362V 4" x 24" Variable-Speed Sander

#### SHARED FEATURES

- Powerful 12 Amp Motor Provides Professional Power
- Motor is Located Over Platen for Maximum Performance & Perfect Balance
- Designed for Flush Sanding up to Vertical Surfaces
- Variable-Speed Dial is Conveniently Placed on the Handle, Allowing Belt Speed Adjustment from 1,000 to 1,500 SFPM
- Quick-Release Belt-Change Lever
- Fingertip Belt-Tracking Knob for Quick, Accurate Belt Adjustments

MODEL #	UNIQUE TOOL FEATURES
360	• 3" X 24" Belt Size
360VS	• 3" X 24" Belt Size, Variable-Speed
362	• 4" X 24" Belt Size
362V	• 4" X 24" Belt Size, Variable-Speed



360



360VS



362



362V

### 371K 2-1/2" x 14" Compact Belt Sander

#### FEATURES

- Textured Rubber Body Grip Provides Comfortable Non-Slip Surface
- Flush Side Enables Sanding up to Perpendicular Surface
- Metal Components Provide Durability for Professional Applications
- Dust Sealed, Recessed Switch Offers Accessibility While Minimizing Unintended Turn-Offs
- Removable Auxiliary Handle Offers Better Control When Two-Handed use is Desired
- Cord Exit Grip Offers Auxiliary Gripping for Various Orientations



## SPECIALTY SANDERS

### 7800 Drywall Sander with Dust Collection

#### FEATURES

- Variable-Speed Dial (1,400-2,000 RPM)
- Built in Dust Collection Hose
- 1-1/4" Vacuum Hose is 13' Long so That Large Areas Can be Sanded in One Set up
- Finish Walls & Ceiling Three to Four Times Faster Than with Conventional Methods
- Lightweight, Easy to Handle
- Operator Can Sand 10' Ceilings without Using Stilts or a Scaffold
- Motor is Located on the Opposite End of the Handle from the Sanding Head for Best Balance & Control
- Patented Foam-Backed Abrasive Sanding Pads Virtually Eliminate Swirl Marks
- Articulating Sanding Head Enables Operator to Sand from Top to Bottom of a Wall or Ceiling without Changing Positions
- Brush-Type Skirt Surrounds the Sanding Pad, Preventing Pad from Gouging Wall Joint
- Powerful Motor Features Serviceable Brushes
- Standard Equipment: Sander, Sanding Pad, 13' Static-Dissipating 1-1/4" Vacuum Hose & Hook & Loop Straps for Mounting Power Cord to Vacuum Hose. Vacuum Not Included



### 7403 Power Paint Remover

#### FEATURES

- 8 Amp, AC Only
- Variable-Speed Dial 3,300-4,500 RPM
- Fast, Uniform, Controlled Removal of Paint from Wood, Compositions, & Many Other Surfaces
- Vertical & Horizontal Adjustments for Uniform Removal
- Uses Tungsten Carbide Discs of 24, 36, & 46 Grit
- 100% Ball Bearings
- Adjustable Side Handle Mounts Right or Left
- Standard Equipment: Paint Remover, Side Handle #875042, Back-up Pad #18018, Wrench #48233, 36G Carbide Disc #18027, Allen Wrench, & Operating Manual



## RIGHT ANGLE RANDOM ORBIT POLISHER

### 7424XP 6" Variable-Speed Random-Orbit Polisher

#### FEATURES

- 3.7 Amps, AC Only
- Electronic Variable-Speed 2,500-6,000 OPM
- Random, Swirl-Free Polishing Action
- Spiral/Bevel Gears
- 100% Ball Bearings
- Standard Equipment: Polisher, Polishing Pad #54745, Wrench #48779, & Side Handle



# STATIONARY & SPECIALTY

## PLANER

### PC305TP 12-1/2" Planer

#### FEATURES

- Powerful 15 Amp Motor for Superior Stock Removal
- Two Knife, Quick Change, Solid Steel Cutter, Head Mounted on Ball Bearings, Assures Smooth Operation & Long Life
- High Carbon Steel, Double Edged, Reversible Knives for Twice The Cutting Life
- Patented Cutter Elevation on Four Precision Ground Columns for Superior Cut Stability
- Poly V Belt Cutter Head Drive With Rugged Gearbox/Chain & Sprocket Feed Roller Drive for Maximum Power Transfer



## JOINTER

### PC160JT 6" Jointer

#### FEATURES

- Variable 6,000 to 11,000 RPM Speed Range for a Variety of Material Sizes & Hardness
- Two Knife Cutter Head with Jack Screw Knife Leveling Arrangement
- Self Adjusting Clamp Adjusts Automatically to Material Thickness
- Built-In Cutter Head Lock Facilitates Knife Replacement & Adjustment
- Extra Large Table Provides Ample Work Support & Surfacing Stock up to a Full 6" Wide
- Center Mounted Fence Gives Needed Support Throughout the Cut for Accurate Edge Jointing



## VAC & ACCESSORIES

### 7812 10 Gallon Wet/Dry Vacuum

#### FEATURES

- Powerful 9 Amp Motor
- Vacuum Delivers 99.85% Filtration Efficiency - Great for Fine Particulate Pick-up, Like Drywall or Solid-Surface Dust
- Built-in Outlet for use with Power Tools - Vacuum Starts Automatically When Tool is Turned on
- Includes 15 Second Vacuum Overrun to Clear Hose When Tool is Turned Off
- Dual Filtration System with Washable Automotive-Type Paper Filter & 2-Ply Ten-Gallon Paper Filter Bag for Dust Pick-up
- Corrosion Resistant Polypropylene Tank
- Large Wheels for Easy Maneuvering
- Convenient Flat Top Surface Tray for Holding Tools While Working
- 83 dBA
- Standard Equipment: Vacuum & Hose



### 78110

#### ACCESSORY KIT

#### INCLUDES

- 2 Suction Tubes
- 1 Bend Tube
- 1 Universal Brush
- 1 Universal Floor Tool
- Crevice Tool



### 78114

#### FILTER BAGS

### 78121

### 78141



MODEL #	DESCRIPTION
78114	for Model 7810- 3 per pkg, 2 Ply, 5 Gal.
78121	for Model 7812- 3 per pkg, 2 Ply, 10 Gal.
78141	for Model 7814- 3 per pkg, 2 Ply, 15 Gal.

### 78115

#### EXHAUST FILTERS

### 78117



MODEL #	DESCRIPTION
78115	for Model 7810- 5.7 sq.ft. Washable & Reuseable
78117	for Model 7812 & 7814- 5.7 sq.ft. Washable & Reuseable

## DOVETAIL & JOINERY

**4210** 12" Dovetail Jig with 4211 Template



**4212** 12" Deluxe Dovetail Jig with 4211 and 4213 Templates



**4216** 12" Deluxe Dovetail Jig Combination Kit with 4211, 4213 and 4215 Templates

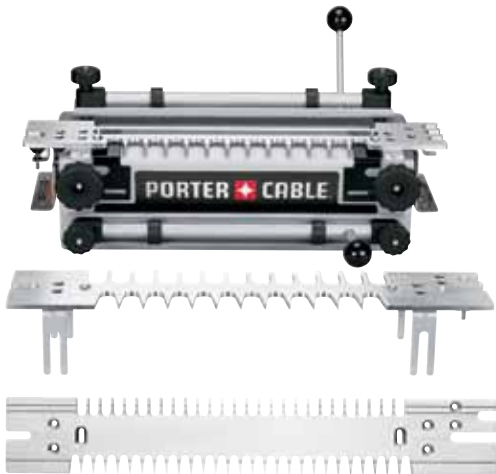

**77240** 24" OMNIJIG® Joinery System with 77241 Template



### Basic Joint Capability at a Glance

MODEL #	VARIABLE SPACED THROUGH DOVETAILS	VARIABLE SPACED HALF-BLIND DOVETAILS	SINGLE-PASS (FIXED) HALF-BLIND DOVETAILS	SLIDING DOVETAILS	RABBETED HALF-BLIND DOVETAILS	BOX (FINGER) JOINTS	MINI THROUGH DOVETAILS
4210	With 4213*	Y*	Y	Y	Y	With 4213	With 4215
4212	Y*	Y*	Y	Y	Y	Y	With 4215
4216	Y*	Y*	Y	Y	Y	Y	Y
77240	Y	Y	Y	With 77248	Y	With 77245	With 77246

\* Advanced techniques required and limitations may apply

## DOVETAIL

- 4210** 12" Dovetail Machine
- 4212** 12" Deluxe Dovetail Machine
- 4216** 12" Deluxe Dovetail Jig Combo Kit

### SHARED FEATURES

- Durable, Single-Piece Steel Base Design Requires No Assembly & Allows for Clamping or Bolting Directly to the Work Bench
- On-Board Instruction Provides Clear User Guidance for the Various Applications
- Patent Pending Template Alignment Lines & Router Bit Depth Gauges Allow for Quick & Easy Set-up
- Heavy-Duty Cam-Style Clamps with Sandpaper Backed Locking Bars Provide a Firm Grip of the Wood
- Machined Aluminum Template Provides Superior Cutting Accuracy & Long Term Durability
- Accommodates Stock from 1/4" to 1-1/8" Thick

MODEL #	UNIQUE TOOL FEATURES
4210	<ul style="list-style-type: none"> <li>• Cuts Half-Blind, Rabbeted Half-Blind, &amp; Sliding Dovetails</li> <li>• Includes Template 4211, Router Bit, Template Guide &amp; Lock Nut</li> </ul>
4212	<ul style="list-style-type: none"> <li>• Cuts Through Dovetails, Box Joints (With Additional Router Bits), Half Blind, Rabbeted Half-Blind, &amp; Sliding Dovetails.</li> <li>• Includes Templates 4211, 4213, Two Router Bits, Two Template Guides &amp; Two Lock Nuts</li> </ul>
4216	<ul style="list-style-type: none"> <li>• Cuts Standard &amp; Mini Through Dovetails, Standard &amp; Mini Box Joints (With Additional Router Bits), Standard &amp; Mini Half-Blind Dovetails, Rabbeted Half-Blind Dovetails, &amp; Sliding Dovetails.</li> <li>• Includes Templates 4211, 4213, 4215, Four Router Bits, Four Template Guides &amp; Two Lock Nuts</li> </ul>

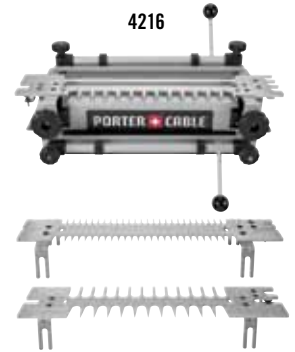
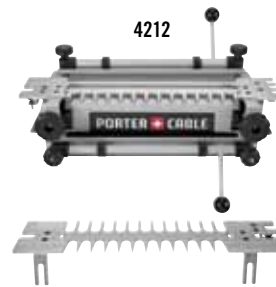
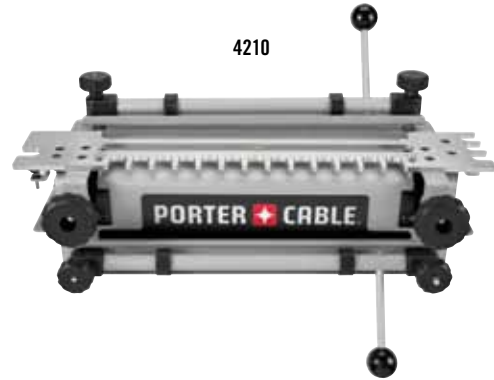

### 4200 Series Dovetail Jig Accessories

MODEL #	DESCRIPTION	APPLICATION
43776PC	17/32" 7 Degree Dovetail Bit	Through and half-blind dovetails
43743PC	13/32" Straight Bit	Through dovetails
43777PC	9/32" 7 Degree Dovetail Bit	Mini half-blind and through dovetails
43014PC	3/16" Straight Bit	Mini through dovetails
43058PC	1/2" Straight Bit	Box joints
43802PC	1/4" Straight Bit	Mini box joints
42040	3/4" Template Guide	for use w/ 43776PC bit
42046	5/8" Template Guide	for use w/ 43743PC bit
42037	3/8" Template Guide	for use w/ 43777PC bit
42054	5/16" Template Guide	for use w/ 43014PC bit

4211 Half-Blind, Rabbeted Half-Blind & Sliding Dovetail Template Kit\*\*



4213 Through Dovetails & Box Joint Template Kit\*\*



4215 Miniature Dovetail Template Kit\*\*



for more information on dovetail jigs & accessories, visit [deltaportercable.com/jigs](http://deltaportercable.com/jigs)

## DOVETAIL JIGS

### Applications & Capacities

#### JOINT APPLICATIONS

MODEL #	THROUGH					HALF-BLIND			
	FIXED SPACED THROUGH	VARIABLE SPACED THROUGH	NARROW PINS THROUGH	FIXED SPACED MINIATURE THROUGH	VARIABLE SPACED MINIATURE THROUGH	SINGLE PASS FIXED SPACED HALF-BLIND	VARIABLE SPACED HALF-BLIND	NARROW PINS HALF-BLIND	FIXED SPACED MINIATURE HALF-BLIND
4210	With 4213	With 4213**	No	With 4215	With 4215**	Yes	Yes**	With 4215**	With 4215
4212	Y	Yes**	No	With 4215	With 4215**	Yes	Yes**	With 4215**	With 4215
4216	Y	Yes**	No	Yes	Yes**	Yes	Yes**	Yes**	Yes
77240	Y	Yes	Yes	With 77246	With 77246	Yes	Yes	With 77246	With 77246

#### JOINT APPLICATIONS CONT.

MODEL #	HALF-BLIND		SLIDING DOVETAIL	BOX				ADVANCED	
	VARIABLE SPACED MINIATURE HALF-BLIND	RABBETED HALF-BLIND	SLIDING DOVETAIL	FIXED SPACED BOX (FINGER)	VARIABLE SPACED BOX (FINGER)	FIXED SPACED MINIATURE BOX (FINGER)	VARIABLE SPACED MINIATURE BOX (FINGER)	INLAID DOVETAILED	ANGLE JOINTS
4210	With 4215**	Yes	Yes	1/2" With 4213*	No	1/4" With 4215*	No	Yes**	Yes**
4212	With 4215**	Yes	Yes	Yes - 1/2" *	No	1/4" With 4215*	No	Yes**	Yes**
4216	Yes**	Yes	Yes	Yes - 1/2" *	No	Yes - 1/4" *	No	Yes**	Yes**
77240	With 77246	Yes	With 77248***	With 77245	With 77245	With 77246	With 77246	Yes**	Yes**

# DOVETAIL & JOINERY

## BOARD CAPACITIES

MODEL #	MAXIMUM THICKNESS	MINIMUM THICKNESS	MAXIMUM WIDTH	MAXIMUM THROUGH DOVETAIL THICKNESS	MAXIMUM HALF-BLIND DOVETAIL THICKNESS
4210	1-1/8"	1/4"	12" <sup>††</sup>	1" **	1-1/8"
4212	1-1/8"	1/4"	12" <sup>††</sup>	1" **	1-1/8"
4216	1-1/8"	1/4"	12" <sup>††</sup>	1" **	1-1/8"
77240	1-1/2"	1/8"	24" <sup>††</sup>	1-1/2"	1-1/2"



## Features & Benefits

FEATURES		BENEFITS	4210	4212	4216	77240
Pre-Assembled	Quick Set-Up		Yes	Yes	Yes	Yes
Directly Attaches to Work Bench			Yes - Clamp or Drill	Yes - Clamp or Drill	Yes - Clamp or Drill	Yes - Clamp or Drill
Pre-Set Router Bit Depth Gauges	Application Repeatability / Minimized Test Cuts		Yes	Yes	Yes	Yes
Board Alignment Lines			Yes	Yes	Yes	With 77248
Pre-Set Template Positioning Stops			No	No	No	Yes <sup>††</sup>
On-Board Operating Instructions	Ease of Use		Yes	Yes	Yes	Yes
Single Lever Cam Action Clamping Mechanism			Yes	Yes	Yes	Yes
Router Stabilizer Bar			No	No	No	Yes
Precision Machined Templates and/or Adjusting Fingers	Superior Joint Accuracy		Yes	Yes	Yes	Yes
Textured Clamping Surfaces			Yes - Abrasive Coating	Yes - Abrasive Coating	Yes - Abrasive Coating	Yes - Machined Aluminum
1/2" Shank Router Bits			Yes <sup>‡</sup>	Yes <sup>‡</sup>	Yes <sup>‡</sup>	Yes <sup>‡</sup>
Metal Jig Base	Long Term Durability		Single Piece Steel	Single Piece Steel	Single Piece Steel	Pivoting 2-Piece Aluminum
Metal Clamping Bars & Levers			Yes	Yes	Yes	Yes
Dust Collection Shroud	System Support		No	No	No	77244
Accessory Storage Case			No	No	No	77249

\* Requires straight bit(s) to complete application

\*\* Advanced techniques are required to achieve the joint and limitations may apply

\*\*\* Sliding dovetail is tapered to assist in the assembly of joint

† All jigs are capable of handling infinite widths (for through dovetail applications) using advanced techniques

‡ 4200 series uses 1/4" shank bits for all miniature joints while OMNIJIG® uses 1/4" shanks on specific miniature applications

†† Template Positioning Stops provide repeatability across changing applications and material sizes

## JOINERY & ACCESSORIES

### 77240 24" OMNIJIG® Joinery System

#### FEATURES

- Pre-Assembled & Factory Set to Minimize User Set-up Time
- Durable Base Design Allows for Clamping or Bolting Directly onto Work Bench
- Clear & Concise On-Board Instructions Guide the User Through the Various Applications While Significantly Reducing the Need to Refer to Instruction Manual
- Adjustable Finger Template Enables User to Cut Variable-Spaced Half-Blind & Through Dovetails
- Fix-Spaced, Half-Blind Dovetails Can Also be Cut With a Single Pass of the Router on This Versatile Jig
- Adjustable, Split Finger Design Allows User to Change Both Position & Width of the Pins for the Chosen Joint Style



### OMNIJIG® Joinery System Template Guides

MODEL #	DESCRIPTION
77266 - Template Guide G0	Replacement Template Guide Used for the Cutting of Large Through Dovetails up to 1-1/2" Thick Wood
77255 - Template Guide G1	Replacement Template Guide Used For The Cutting of Tails in Through Dovetail Applications
77256 - Template Guide G2	Replacement Template Guide Used for Specific Through, Variable-Spaced & Single-Pass Half-Blind Dovetail Applications
77257 - Template Guide G3	Replacement Template Guide Used for Specific Variable-Spaced & Single-Pass Half-Blind Dovetail Applications
77258 - Template Guide G4	Replacement Template Guide Used for Specific Variable-Spaced & Single-Pass Half-Blind Dovetail Applications

MODEL #	DESCRIPTION
77259 - Template Guide G5	Replacement Template Guide Used for Specific Variable-Spaced & Single-Pass Half-Blind Dovetail Applications
77260 - Template Guide G6	Replacement Template Guide Used for Cutting Pins on Specific Through Dovetail Applications
77261 - Template Guide G7	Replacement Template Guide Used for Specific Miniature Through & Variable-Spaced Half-Blind Dovetail Applications
77262 - Template Guide G8	Replacement Template Guide Used for Specific Miniature Through & Variable-Spaced Half-Blind Dovetail Applications

### Bits Designed Specifically for use with the OMNIJIG® Joinery System

	MODEL #	DEGREE/FLUTES	CUTTING DIAMETER	FLUTE LENGTH	SHANK DIAMETER	TOTAL LENGTH	MATERIAL
Dovetail Bits	430D0PC	7°/2	1/4"	13/32"	1/4"	2-3/4"	High Speed Steel
	430D1PC*	7°/2	9/32"	17/32"	1/4"	2-3/4"	High Speed Steel
	430D2PC	7°/2	5/16"	21/32"	1/4"	2-7/8"	High Speed Steel
	430D3PC	7°/2	3/8"	3/4"	1/2"	3-1/8"	Carbide-tipped
	430D4PC**	7°/2	1/2"	25/32"	1/2"	3-1/8"	Carbide-tipped
	430D5PC	7°/2	9/16"	1-1/32"	1/2"	3-1/4"	Carbide-tipped
	430D6PC	7°/2	3/4"	1-17/32"	1/2"	3-1/2"	Carbide-tipped
Straight Bits	430S0PC***	0°/2	9/32"	25/32"	1/4"	3-1/8"	Solid Carbide, spiral upcut
	430S1PC*	0°/2	1/4"	21/32"	1/4"	3"	Solid Carbide, spiral upcut
	430S2PC†	0°/2	3/8"	1-17/32"	1/2"	3-1/4"	Carbide-tipped
	430S3PC	0°/2	31/64"	1-17/32"	1/2"	3-1/4"	Carbide-tipped

\* Included with mini accessory \*\* Included with both OMNIJIG®s \*\*\* Included with mini box joint kit † Included with 24" OMNIJIG® ‡ Included with standard box joint kit

### 77241 24" Variable Finger Template

#### FEATURES

- Replacement adjustable finger template for the 24" OMNIJIG® Joinery System (77240)



### 77244 24" Dust Hood

#### FEATURES

- Quickly attaches to the jig - no additional components required
- Keeps work area clean when used in conjunction with OMNIJIG® stabilizer bar (included with Model 77240)
- Directs chips to a single point for collection underneath the jig
- 4" diameter hose port allows for direct attachment to a standard dust collection system



# DOVETAIL & JOINERY

**77246**

## 24" Miniature Variable Finger Template

### FEATURES

- Enables miniature variable-spaced through and half-blind joints to be cut

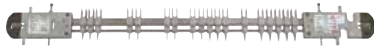

**77248**

## 24" Half-Blind / Sliding - Tapered Dovetail Template

### FEATURES

- Fixed-space template enables half-blind dovetails to be cut with a single pass of the router
- Sliding tapered dovetails can also be cut with this versatile template



## Dovetail Setup Guide

Quick reference card that eliminates the need to constantly refer to the manual. Included with the 77240 OMNIJIG and all variable finger templates.

**A THROUGH**

**STANDARD SIZE**

MAXIMUM WOOD THICKNESS	STOPS	A•TAILS		A•PINS	
		DOVETAIL BIT	TEMPLATE GUIDE	STRAIGHT BIT	TEMPLATE GUIDE
1/2" *	A1	D1	G1	S2	G6
5/8" *	A2	D2			
3/4" *	A3	D3			
3/4" *	A4	D4			G2
1"	A5	D5			G0
1-1/2"	A6	D6			
MAXIMUM WOOD THICKNESS	STOPS	DOVETAIL BIT	TEMPLATE GUIDE	STRAIGHT BIT	TEMPLATE GUIDE
3/8" *	A7	D0	G7	S1	G8
1/2" *	A8	D1			
5/8" *	A9	D2			

**B VARIABLE-SPACED HALF-BLIND**

**STANDARD SIZE**

TALL HEIGHT (APPROXIMATE)	STOPS	DOVETAIL BIT	TEMPLATE GUIDE
1/4"	B1	D4	G2
3/8"			G3
1/2"			G4
5/8"			G5

**MINIATURE**

TALL HEIGHT (APPROXIMATE)	STOPS	DOVETAIL BIT	TEMPLATE GUIDE
1/4" *	B2	D0	G8
3/8" *		D1	G8
1/2" *		D2	G7
5/8" *		D2	G7

\* Capable of making dovetails with narrow pins

**C SINGLE-PASS HALF-BLIND**

**STANDARD SIZE**

TALL HEIGHT (APPROXIMATE)	STOPS	DOVETAIL BIT	TEMPLATE GUIDE
1/4"	C1	D4	G2
3/8"			G3
1/2"			G4
5/8"			G5

Half-Blind Tail Height

## Dovetail Accessories

### DOVETAIL BITS (ALL 7°)

SYMBOL	CUTTING DIAMETER	FLUTE LENGTH	SHANK DIAMETER	CATALOGUE NUMBER
D0	1/4"	13/32"	1/4"	430D0PC
D1	9/32"	17/32"	1/4"	430D1PC
D2	5/16"	21/32"	1/4"	430D2PC
D3	3/8"	25/32"	1/2"	430D3PC
D4	1/2"	25/32"	1/2"	430D4PC
D5	9/16"	1-1/32"	1/2"	430D5PC
D6	3/4"	1-17/32"	1/2"	430D6PC

### STRAIGHT BITS

SYMBOL	CUTTING DIAMETER	FLUTE LENGTH	SHANK DIAMETER	CATALOGUE NUMBER
S1	1/4"	21/32"	1/4"	430S1PC
S2	3/8"	1-17/32"	1/2"	430S2PC

### TEMPLATE GUIDES

SYMBOL	OD	ID	DISTANCE PAST BASE	CATALOGUE NUMBER
G0	85/128"	19/32"	3/8"	77266
G1	5/8"	17/32"	3/8"	77255
G2	39/64"	17/32"	3/8"	77256
G3	19/32"	17/32"	3/8"	77257
G4	37/64"	17/32"	3/8"	77258
G5	9/16"	17/32"	3/8"	77259
G6	15/32"	27/64"	3/8"	77260
G7	3/8"	21/64"	15/32"	77261
G8	23/64"	5/16"	15/32"	77262

**OMNIJIG®**  
JOINERY SYSTEM

## JOINERY CONT.

### 557 Deluxe Plate Joiner Kit

#### FEATURES

- 7.5 Amp, 120 Vac Only, 10,000 RPM
- Fence Tilts from 0 Degrees to 135 Degrees with Positive Adjustable Stop at 90 Degrees
- Precise Micro Height-Adjustment Knob
- Lock-on Trigger
- Height Scale Accurate at Any Angle
- Seven-Position Rotating Depth Stop for FF, #0, #10, #20, Simplex, Duplex, & Max (#6) Biscuits
- Spindle Lock for Easy Blade Changes
- Bale Handle Attached to Fence, Not Motor, for Greater Stability & Added Control During Cuts
- 1" O.D. Dust Port Accepts Standard Bag or Can be Connected to a Vacuum
- Standard Equipment: Plate Joiner, 4" Blade #5558, Centering Plate #888776, Dust Bag #883175, Chip Deflector #886490, Allen Wrench #891869, Carrying Case, & Operating Manual



#### Plate Joining Biscuits



MODEL #	DESCRIPTION
5550	Box of 1000 - "FF" (13 mm x 30 mm)
5551	Box of 1000 - "0" (16 mm x 47 mm)
5552	Box of 1000 - "10" (20 mm x 52 mm)
5553	Box of 1000 - "20" (24 mm x 58 mm)
5554	"Assorted" (500x"20")(250x"10")(250x"0")



MODEL #	DESCRIPTION
5560	Tube of 150 - "0" (16 mm x 47 mm)
5561	Tube of 150 - "10" (20 mm x 52 mm)
5562	Tube of 150 - "20" (24 mm x 58 mm)
5563	Tube of 150 - "FF" (13 mm x 30 mm)

Re-usable container to keep Your biscuits fresh & dry

### 560 QUIK JIG™ Pocket Hole Joinery System

#### FEATURES

- Automatic Depth Control System Allows for Easy Set up for Different Material Thicknesses
- Variable-Spaced Bushings Allow a Variety of Positions for the Pocket Holes
- Self Adjusting Clamp Adjusts Automatically to Material Thickness
- Repeatable Clamp Makes Multiple Pieces Quick & Easy
- Screw Length Gauge Recommends the Appropriate Screw Length for Material Thickness
- Built-in Drill Bit Collar Set up Does Not Need to be Changed for Different Material Thicknesses
- Removable Dust Port Can be Hooked up to a Porter Cable Dust Extractor or Standard Vacuum



# PORTER CABLE®

## CONSTRUCTION TOOLS





**12V<sup>MAX</sup>  
LITHIUM**

## COMPACT & LIGHTWEIGHT



**LITHIUM**  
**PCL12BLX**  
Lightweight, Compact  
12V MAX<sup>†</sup> Battery  
with 30 Minute  
Charge Time\*



**18v**<sup>TM</sup>  
SYSTEM

## ALL PORTER-CABLE 18V TOOLS ARE COMPATIBLE WITH ANY PORTER-CABLE 18V BATTERY



**NiCd**  
Proven Performance  
PC18B



**LITHIUM LX**  
Lightweight, Compact  
& Longer Run-time\*\*  
PC18BLX



**LITHIUM EX**  
Exceptional Run-time  
& Performance  
PC18BLEX

## LITHIUM

### 12V MAX<sup>†</sup> Compact 3/8" Drill / Driver

#### PCL120DDC-2

- 2-Speed Gearbox
- Adjustable Clutch
- Variable-Speed Trigger
- 7-1/2" Length
- Integral L.E.D. Worklight
- Belt Clip



#### SPECIFICATIONS

VOLTS	12V MAX <sup>†</sup>
MAX TORQUE	220 in.-lbs.
RPM	0-315/0-1,200
CHUCK SIZE	3/8" single sleeve
WEIGHT	2.4 lbs. with battery
CHARGE TIME	30 min.*
INCLUDES	(2) PCL12BLX 12V MAX <sup>†</sup> Lithium Ion batteries, (1) PCL12C 12V MAX <sup>†</sup> Lithium Ion fast charger, (1) belt hook, (1) double ended bit tip & (1) storage bag

## LITHIUM

### 12V MAX<sup>†</sup> Compact 1/4" Hex Impact Driver

#### PCL120IDC-2

- 1/4" Hex Quick-Release Chuck
- Variable-Speed Trigger
- 6-1/2" Length
- Integral L.E.D. Worklight
- Belt Clip



#### SPECIFICATIONS

VOLTS	12V MAX <sup>†</sup>
MAX TORQUE	950 in.-lbs.
RPM	0-2,400
BPM	0-2,500
CHUCK SIZE	1/4" quick release hex
WEIGHT	2.6 lbs. with battery
CHARGE TIME	30 min.*
INCLUDES	(2) PCL12BLX 12V MAX <sup>†</sup> Lithium Ion batteries, (1) PCL12C 12V MAX <sup>†</sup> Lithium Ion fast charger, (1) belt hook, (1) PH #2 screwdriving bit, & (1) storage bag

## LITHIUM

### 12V MAX<sup>†</sup> Compact 2-Tool Kit Drill/Driver & Impact Driver

#### PCL212IDC-2



#### SPECIFICATIONS

VOLTS	12V MAX <sup>†</sup>	12V MAX <sup>†</sup>
MAX TORQUE	220 in.-lbs.	950 in.-lbs.
RPM	0-315/0-1,200	0-2,400
BPM	--	0-2,500
CHUCK SIZE	3/8" single sleeve	1/4" quick release hex
WEIGHT	2.4 lbs. with battery	2.6 lbs. with battery
CHARGE TIME	30 min.*	30 min.*
INCLUDES	(2) PCL12BLX 12V MAX <sup>†</sup> Lithium Ion batteries, (1) PCL12C 12V MAX <sup>†</sup> Lithium Ion fast charger, (2) belt hooks (1) double ended bit, (1) PH #2 screwdriving bit & (1) storage bag	

## LITHIUM

### 12V MAX<sup>†</sup> CLAMPSAW™

#### PCL120CRC-2

- Adjustable Clamping Shoe
- 3-Position Pivoting Handle
- Tool-Free Blade Release
- Compact Size & Lightweight
- Integral L.E.D. Worklight



#### SPECIFICATIONS

VOLTS	12V MAX <sup>†</sup>
SPM	0-3,000
STROKE LENGTH	5/8"
WEIGHT	3.4 lbs. with battery
CHARGE TIME	30 min.*
INCLUDES	(2) PCL12BLX 12V MAX <sup>†</sup> Lithium Ion batteries, (1) PCL12C 12V MAX <sup>†</sup> Lithium Ion fast charger, (1) 4" metal cutting blade, (1) 4" wood cutting blade, (1) hex key for clamping shoe & (1) storage bag



<sup>†</sup> Maximum initial battery pack voltage (measured without a workload) is 12 volts. Nominal voltage is 10.8.

## LITHIUM

### 32 Pc. 18V Oscillating Multi-Tool Kit

#### PCCCK510LA

- Tool-Free System
- Variable-Speed Dial
- Integral L.E.D Worklight

#### SPECIFICATIONS

VOLTS	18V
OPM	7,500-15,000
OSCILLATING ANGLE	2.8 Degrees
WEIGHT	2.8 lbs.
INCLUDES	(1) wood blade, (1) wood/metal blade, (1) 1/2 segment wood/ drywall blade, (1) sanding platen, (24) sand paper sheets, (1) grout removal blade, (1) flexible scraper, (1) rigid scraper (1) accessory box, (1) PC18BLX 18V Lithium Ion battery, (1) PCXMvc 18V Multi-Chemistry charger & (1) storage bag

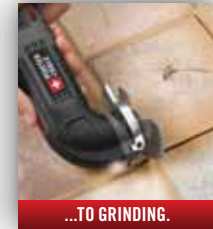
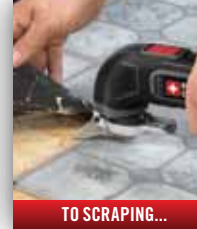

### Available Accessories

CUTTING	SKU	APPLICATION
	PC3010 1-1/4" PRECISION PLUNGE CUT BLADE	Rough & plunge cutting in plastic, wood & drywall
	PC3011 1-1/4" WOOD PLUNGE CUT BLADE	Finish cuts in plastic, hardwood & drywall such as door jambs, moulding & trim, PVC pipe & flooring
	PC3012 1-1/4" WOOD/METAL PLUNGE CUT BLADE (BI-METAL)	Finish cuts in plastic, hardwood, metal & drywall such as door jambs, moulding & trim, PVC/copper pipe, nails & flooring
	PC3013 4" FLUSH CUT BLADE (HSS)	Cuts openings in drywall, plywood, hardwood & flooring
SANDING	SKU	APPLICATION
	PC3005 SANDING PAD (H&L)	For use with PC3002
	PC3002 60-120-240G SANDPAPER 6PK WOOD (H&L)	Sands hardwood materials, softwood materials & metal
SCRAPING	SKU	APPLICATION
	PC3020 RIGID SCRAPER BLADE	Removes adhesive tiles, vinyl flooring & carpet. Scrapes paint, varnish or thinset
	PC3021 FLEXIBLE SCRAPER BLADE	Removes softer materials such as caulk & glue residue
GRINDING	SKU	APPLICATION
	PC3030 CARBIDE GROUT REMOVAL BLADE	Removes grout for tile replacement or repair

## LITHIUM

### 18V 1/2" Drill / Driver Kit

#### PCL180CDK-2

- All Metal 1/2" Keyless Chuck
- 2-Speed High Torque/High Speed Gearbox (0-350/0-1,500)
- Contoured Handle with Overmold
- Integral L.E.D. Worklight



#### SPECIFICATIONS

VOLTS	
MAX TORQUE	
RPM	
WEIGHT	
CHARGE TIME	
BATTERY TYPE	
INCLUDES	



### 18V 1/2" NiCd Drill / Driver Kit

#### PC180DK-2

- 1/2" Keyless Chuck
- High Performance Motor & 2-Speed Gearbox
- Integral L.E.D. Worklight



#### SPECIFICATIONS

VOLTS	18V
MAX TORQUE	440 in.-lbs.
RPM	0-350/0-1,400
WEIGHT	5.1 lbs. weight with PC18B battery
CHARGE TIME	1 hour
BATTERY TYPE	NiCd
INCLUDES	(2) PC18B 18V NiCd batteries, (1) PCMVC 18V NiCd 1 hour charger, (1) double-ended bit & (1) kit box

### 18V 1/2" NiCd Hammerdrill Kit

#### PC180CHDK-2

- 1/2" Locking Chuck
- 2-Speed High Torque/ High Speed Gearbox (0-350/0-1,500)
- Hammer Action for Masonry Drilling
- Contoured Handle with Overmold



#### SPECIFICATIONS

VOLTS	18V
MAX TORQUE	424 in.-lbs.
RPM	0-350/0-1,500
BPM	0-25,500
WEIGHT	5.1 lbs. weight with PC18B battery
CHARGE TIME	1 hour
BATTERY TYPE	NiCd
INCLUDES	(2) PC18B 18V NiCd batteries, (1) PCMVC 18V NiCd 1 hour charger, (1) double-ended bit & (1) kit box

## LITHIUM

### 18V 1/4" Impact Driver Kit

#### PCL180IDK-2

- Quick-Release 1/4" Hex Chuck
- Variable-Speed Trigger
- Integral L.E.D. Worklight



#### SPECIFICATIONS

VOLTS	18V
MAX TORQUE	1,600 in.-lbs.
RPM	0-2,900
BPM	0-2,800
CHUCK	1/4" quick release hex
WEIGHT	3.6 lbs. weight with PC18BLX battery
CHARGE TIME	30 min.
BATTERY TYPE	Lithium Ion
INCLUDES	(2) PC18BLX 18V Lithium Ion batteries, (1) PCXMCV 18V Multi-Chemistry charger, (1) PH #2 screwdriving bit, (1) belt clip & (1) storage bag

### 18V 1/4" NiCd Impact Driver Kit

#### PC180IDK-2

- Quick-Release 1/4" Hex Chuck
- Variable-Speed Trigger
- Integral L.E.D. Worklight



#### SPECIFICATIONS

VOLTS	18V
MAX TORQUE	1,600 in.-lbs.
RPM	0-2,900
BPM	0-2,800
CHUCK	1/4" quick release hex
WEIGHT	4.6 lbs. weight with PC18B battery
CHARGE TIME	1 hour
BATTERY TYPE	NiCd
INCLUDES	(2) PC18B 18V NiCd batteries, (1) PCMVC 18V NiCd 1 hour charger, (1) belt clip, (1) PH #2 screwdriving bit & (1) storage bag

## LITHIUM

### 18V 4-Tool Combo Kit

Drill/Driver, Impact Driver, Reciprocating Saw & Flashlight

**PCL418DC-2**



SPECIFICATIONS	PCL180CD	PCL180ID	PCL180RS	PCL180FL
VOLTS	18V	18V	18V	18V
MAX TORQUE	424 in.-lbs.	1,600 in.-lbs.	--	--
RPM	0-350/0-1,500	0-2,900	--	--
SPM	--	--	0-3,000	--
BPM	--	0-2,800	--	--
STROKE LENGTH	--	--	7/8"	--
CHUCK	1/2"	1/4" quick release hex	--	--
BULB	--	--	--	5W
WEIGHT	3.8 lbs. with PC18BLX battery	3.6 lbs. with PC18BLX battery	5.2 lbs. with PC18BLX battery	1.8 lbs. with PC18BLX battery
INCLUDES	(1) PC18BLEX 18V Lithium Ion Battery, (1) PC18BLX 18V Lithium Ion Battery, (1) PCXMVC 18V Multi-Chemistry charger, (1) double-ended bit, (1) PH #2 screwdriving bit, (1) 6in. woodcutting blade & (1) storage bag			

## LITHIUM

### 18V 4-Tool Combo Kit

Drill/Driver, Circular Saw, Reciprocating Saw & Flashlight

**PCL418C-2**



SPECIFICATIONS	PCL180CD	PCL186CS	PCL180RS	PCL180FL
VOLTS	18V	18V	18V	18V
MAX TORQUE	424 in.-lbs.	--	--	--
RPM	0-350/0-1,500	3,700	--	--
SPM	--	--	0-3,000	--
BLADE	--	6-1/2"	--	--
CUT CAPACITY	--	2-1/8" at 0 degrees bevel	--	--
BEVEL CUT CAPACITY	--	1-3/4" at 50 degrees bevel	--	--
STROKE LENGTH	--	--	7/8"	--
CHUCK	1/2"	--	--	--
BULB	--	--	--	5W
WEIGHT	3.8 lbs. with PC18BLX battery	7.0 lbs. with PC18BLX battery	5.2 lbs. with PC18BLX battery	1.8 lbs. with PC18BLX battery
INCLUDES	(1) PC18BLEX 18V Lithium Ion Battery, (1) PC18BLX 18V Lithium Ion Battery, (1) PCXMVC 18V Multi-Chemistry charger, (1) double-ended bit, (1) 6-1/2" 18T carbide tipped blade, (1) 6" woodcutting blade & (1) storage bag			

## LITHIUM

### 18V 3-Tool Combo Kit

Drill/Driver, Impact Driver, & Reciprocating Saw

**PCCK413L3**



SPECIFICATIONS	PCL180CD	PCL180ID	PCL180RS
VOLTS	18V	18V	18V
MAX TORQUE	424 in.-lbs.	1,600 in.-lbs.	--
RPM	0-350/0-1,500	0-2,900	--
BPM	--	0-2,800	--
CHUCK	1/2"	1/4" quick release hex	--
WEIGHT	3.8 lbs. with PC18BLX battery	3.6 lbs. with PC18BLX battery	5.2 lbs. with PC18BLX battery
INCLUDES	(1) PC18BLEX Extended Run-Time 18V Lithium Ion battery, (1) PC18BLX 18V Lithium Ion battery, (1) PCXMVC 18V Multi-Chemistry Fast charger, (1) double-ended bit, (1) PH #2 screwdriving bit & (1) storage bag		

## LITHIUM

### 18V 2-Tool Combo Kit

Drill/Driver & Impact Driver

**PCCK410L2**



SPECIFICATIONS	PCL180CD	PCL180ID
VOLTS	18V	18V
MAX TORQUE	424 in.-lbs.	1,600 in.-lbs.
RPM	0-350/0-1,500	0-2,900
BPM	--	0-2,800
CHUCK	1/2"	1/4" quick release hex
BULB	--	--
WEIGHT	3.8 lbs. with PC18BLX battery	3.6 lbs. with PC18BLX battery
INCLUDES	(2) PC18BLX 18V Lithium Ion batteries, (1) PCXMVC 18V Multi-Chemistry charger, (1) double-ended bit, (1) PH #2 screwdriving bit & (1) storage bag	

# CORDLESS COMBO KITS



## 18V 2-Tool NiCd Combo Kit

Drill/Driver & Circular Saw

**PC218C-2**



SPECIFICATIONS	PC1801D	PC186CS
VOLTS	18V	18V
MAX TORQUE	440 in.-lbs.	--
RPM	0-350/0-1,400	3,700
BLADE	--	6-1/2"
CUT CAPACITY	--	2-1/8" at 0 degrees bevel
BEVEL CUT CAPACITY	--	1-3/4" at 50 degrees bevel
CHUCK	1/2"	--
WEIGHT	5.1 lbs. with battery	8.0 lbs. with battery
INCLUDES	(2) PC18B 18V NiCd batteries, (1) PCC480M 18V NiCd 3 hour charger, (1) double-ended bit, (1) 6-1/2" 18T carbide tipped blade & (1) storage bag	

## 18V 4-Tool NiCd Combo Kit

Drill/Driver, Circular Saw, Reciprocating Saw & Flashlight

**PC418C-2**



SPECIFICATIONS	PC1801D	PC186CS	PC1800RS	PC1800L
VOLTS	18V	18V	18V	18V
MAX TORQUE	440 in.-lbs.	--	--	--
RPM	0-350/0-1,400	3,700	--	--
SPM	--	--	0-3,000	--
BLADE	--	6-1/2"	--	--
CUT CAPACITY	--	2-1/8" at 0 degrees bevel	--	--
BEVEL CUT CAPACITY	--	1-3/4" at 50 degrees bevel	--	--
STROKE LENGTH	--	--	7/8"	--
CHUCK	1/2"	--	--	--
BULB	--	--	--	5W
WEIGHT	5.1 lbs. with battery	8.0 lbs. with battery	6.2 lbs. with battery	2.6 lbs. with battery
INCLUDES	(2) PC18B 18V NiCd batteries, (1) PCC480M 18V NiCd 3 hour charger, (1) double-ended bit, (1) 6-1/2" 18T carbide tipped blade, (1) 6" woodcutting blade & (1) storage bag			

## 18V 2-Tool NiCd Combo Kit

Drill/Driver & Impact Driver

**PC218IDC-2**



SPECIFICATIONS	PC1801D	PC1800ID
VOLTS	18V	18V
MAX TORQUE	440 in.-lbs.	1,600 in.-lbs.
RPM	0-350/0-1,400	0-2,900
BPM	--	0-2,800
CHUCK	1/2"	1/4" quick release hex
WEIGHT	5.1 lbs. with battery	4.6 lbs. with battery
INCLUDES	(2) PC18B 18V NiCd Batteries, (1) PCC480M 18V NiCd 3 hour charger, (1) double-ended bit, (1) PH #2 screwdriving bit & (1) storage bag	

## 18V Bare 6-1/2" Circular Saw\*

### PC18CS

- 6-1/2" Blade
- Bevel Adjustment up to 50 Degrees
- Electric Brake



#### SPECIFICATIONS

VOLTS	18V
RPM	3,700
BLADE	6-1/2"
CUT CAPACITY	2-1/8" at 0 degrees bevel
BEVEL CUT CAPACITY	1-3/4" at 50 degrees bevel
BATTERY TYPE	NiCd or Lithium Ion
INCLUDES	(1) 6-1/2" blade & (2) AAA batteries (for laser)

## 18V Bare Reciprocating Saw\*

### PC18RS

- Tool-Free Blade Release
- Variable-Speed Trigger
- Pivoting Shoe
- Compact Design



#### SPECIFICATIONS

VOLTS	18V
SPM	0-3,000
STROKE LENGTH	7/8"
BATTERY TYPE	NiCd or Lithium Ion
INCLUDES	(1) 6" woodcutting blade

## 18V Bare **CLAMP**SAW™ Pivoting Reciprocating Saw\*

### PCC475B

- Tool-Free Adjustable Clamping Shoe/Depth
- Compact Design
- 0-3,000 SPM
- Tool-Free Blade Release
- Integral L.E.D. Worklight



#### SPECIFICATIONS

VOLTS	18V
STROKE LENGTH	1"
SPM	0-3,000
KEYLESS BLADE CLAMP	Yes
VARIABLE-SPEED TRIGGER	Yes
BATTERY TYPE	NiCd or Lithium Ion

## 18V Bare 4-1/2" Cut-Off Tool / Angle Grinder\*

### PC18AG

- High Torque Motor
- Cast Metal Gear Housing
- 3-Position Adjustable Side Handle



#### SPECIFICATIONS

VOLTS	18V
RPM	8,500
BATTERY TYPE	NiCd or Lithium Ion
INCLUDES	(1) grinding wheel, (2) cut-off wheels, (1) grinding guard, (1) metal cutting guard, (1) side handle & (1) wrench

## 18V Bare Jig Saw\*

### PC18JS

- Tool-Free Blade Clamp
- Tool-Free Shoe with, 45 Degree Bevel Stops
- 3-Position Orbital Control
- Durable & Accurate Steel Shoe
- Vacuum Attachment Port



#### SPECIFICATIONS

VOLTS	18V
SPM	0-2,500
STROKE LENGTH	3/4"
BATTERY TYPE	NiCd or Lithium Ion
INCLUDES	(1) woodcutting blade & (1) detachable vacuum port

## 18V Bare 2-Speed Close Quarters Drill\*

### PCC520B

- Two Speed Gear Box (0-350/0-1,400)
- Compact Design
- Variable-Speed Trigger
- Single Sleeve 3/8" Keyless Chuck
- Integral L.E.D. Worklight



#### SPECIFICATIONS

VOLTS	18V
RPM	0-350/0-1,400
WEIGHT	2.4 lbs.
BATTERY TYPE	NiCd or Lithium Ion
INCLUDES	(1) double-ended bit

# CORDLESS BARE TOOLS



18V BATTERY & CHARGER SOLD SEPARATELY

## 18V Bare 1/2" Hammerdrill\*

### PC18CHD

- All Metal 1/2" Locking Chuck
- 2-Speed High Torque / High Speed Gearbox (0-350/0-1,500)
- Hammer Action for Masonry Drilling
- Variable-Speed Trigger



#### SPECIFICATIONS

VOLTS	18V
TORQUE	237 in.-lbs.
MAX TORQUE	424 in.-lbs.
RPM	0-350/0-1,500
BPM	0-25,500
WEIGHT	3.3 lbs.
BATTERY TYPE	NiCd or Lithium Ion
CAPACITY	1" Wood 1/2" Metal & Concrete
INCLUDES	(1) double-ended bit

## 18V Bare Detail Sander\*

### PC18DS

- Dust Sealed Switch
- Detachable Detail Finger
- Tapered Platen
- Contoured Gripping Area w/ Overmold



#### SPECIFICATIONS

VOLTS	18V
OPM	10,500
BATTERY TYPE	NiCd or Lithium Ion
INCLUDES	(3) 60 grit sandpaper sheets, (3) 120 grit sandpaper sheets, (1) detail finger attachment & (1) vacuum attachment port



## 18V Bare Impact Driver\*

### PC1801ID

- Quick Release 1/4" Hex Chuck
- Variable-Speed Trigger
- 6-1/2" Length
- Integral L.E.D. Worklight



#### SPECIFICATIONS

VOLTS	18V
MAX TORQUE	1,600 in.-lbs.
RPM	0-2,900
BPM	0-2,800
CHUCK	1/4" quick-release hex
BATTERY TYPE	NiCd or Lithium Ion
INCLUDES	(1) PH #2 screwdriving bit

## 18V Bare Cordless / 120V Corded Jobsite Radio\*

### PC18JR

- Backlit Digital Tuner with Clock, Preset Memory, Bass Boost & Seek
- Weather Resistant Speakers
- Two Pass-Through 120v AC Outlets
- 3.5 mm Auxiliary Input
- Easy to Use, Push-Button Operation



#### SPECIFICATIONS

DC VOLTS	18V
AC VOLTS	120V
AUXILIARY INPUT	3.5 mm
AC OUTLET MAX AMPS	10 Amp
BATTERY TYPE	NiCd or Lithium Ion
INCLUDES	(1) 3.5 mm auxiliary cord

## 18V Bare Hand Vac\*

### PC18HV

- Armor Clad GORE® Filter
- Extension Hose with Crevice Tool
- Works with Vacuum Attachment Ports on Select PORTER-CABLE 18V Tools
- Ergonomic Handle with On-Off Trigger
- Translucent Bowl



#### SPECIFICATIONS

VOLTS	18V
BATTERY TYPE	NiCd or Lithium Ion
INCLUDES	(1) armor clad GORE® filter, (1) flexible extension hose, (1) crevice tool & (1) universal adaptor



\* Battery & charger sold separately

## 18V Bare Inflator\*

**PCC583B**

- Runs Off 18V PORTER-CABLE NiCo or Lithium Ion Battery or Vehicle's 12V Power Adaptor
- High-Pressure & High-Volume Inflation
- Digital LCD Display with Auto Shut Off
- Pressure Gauge



**SPECIFICATIONS**

BATTERY PACK VOLTAGE	18V
AUTO ADAPTOR VOLTAGE	12V
AUTO ADAPTOR FUSE	8A
MAX PSI	150
DC CORD LENGTH	10'
BATTERY TYPE	NiCd or Lithium Ion
INCLUDES	(2) inflation nozzles, (1) inflation needle & (1) high volume hose

## 18V Battery Status Gauge\*

**PCC580B**

- Fully Automatic State of Charge Indication
- Illuminated L.E.D. Lights Show Charge Status
- Automatic Shut Off After 15 Seconds



**SPECIFICATIONS**

VOLTS	18V
BATTERY TYPE	NiCd or Lithium Ion

## 18V Bare Pivoting Flashlight\*

**PC18FL**

- Pivoting Head
- Adjustable Beam
- up to 8.5 Hours Run-Time



**SPECIFICATIONS**

VOLTS	18V
BULB	5W
RUN TIME	Up to 8.5 hours (PC18BLEX)
BATTERY TYPE	NiCd or Lithium Ion

## 18V Bare Area Light\*

**PC18AL**

- Pivoting Handle & Base
- Light Focus Rotates 360 Degrees
- 13W Low-Heat Fluorescent Light
- Open Hanging Hook



**SPECIFICATIONS**

VOLTS	18V
BULB	13W
BATTERY TYPE	NiCd or Lithium Ion

**PCC581B**

## 18V Bare Infrared Thermometer\*

**PCC582B**

## 9V Bare Alkaline Infrared Thermometer

- Temperature Indicator Beam Shows Temperature Changes
- 12:1 Distance/Spot Ratio
- Stores up to 10 Readings
- Measures Temperature From -22 Degrees Fahrenheit to 590 Degrees Fahrenheit
- +/- 1.8 Degrees Fahrenheit Accuracy



**SPECIFICATIONS**

DISTANCE/ SPOT RATIO	12:1
TEMPERATURE RANGE	-22 Degrees Fahrenheit to 590 Degrees Fahrenheit

MODEL #	BATTERY TYPE
PCC581B	18V Bare Tool
PCC582B	9V Alkaline Battery

**TEMPERATURE INDICATOR BEAM**

COOL SPOT

REF TEMP

HOT SPOT



REFERENCE TEMPERATURE



# CORDLESS BARE TOOLS



18V BATTERY & CHARGER SOLD SEPARATELY

## 18V Bare Oscillating Multi-Tool Kit with 32 Accessories\*

### PCCK510LA

- Tool-Free Accessory Changing System
- Variable Speed Dial
- Integral L.E.D. Worklight

#### SPECIFICATIONS

<b>VOLTS</b>	18V
<b>OPM</b>	7,500-15,000
<b>OSCILLATING ANGLE</b>	2.8 Degrees
<b>WEIGHT</b>	1.9 lbs.
<b>INCLUDES</b>	(1) wood blade, (1) wood/metal blade, (1) 1/2 segment wood/ drywall blade, (1) sanding platen, (24) sand paper sheets, (1) grout removal blade, (1) flexible scraper, (1) rigid scraper & (1) accessory box



SWITCH from CUTTING...

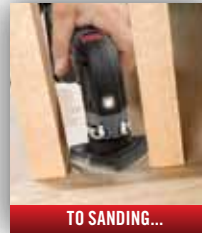

TO SANDING...



TO SCRAPING...

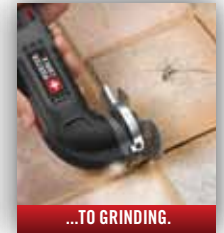

...TO GRINDING.

## Available Accessories

CUTTING	SKU	APPLICATION
	PC3010 1-1/4" PRECISION PLUNGE CUT BLADE	Rough & plunge cutting in plastic, wood & drywall
	PC3011 1-1/4" WOOD PLUNGE CUT BLADE	Finish cuts in plastic, hardwood & drywall such as door jambs, moulding & trim, PVC pipe & flooring
	PC3012 1-1/4" WOOD/METAL PLUNGE CUT BLADE (BI-METAL)	Finish cuts in plastic, hardwood, metal & drywall such as door jambs, moulding & trim, PVC/copper pipe, nails & flooring
	PC3013 4" FLUSH CUT BLADE (HSS)	Cuts openings in drywall, plywood, hardwood & flooring
SANDING	SKU	APPLICATION
	PC3005 SANDING PAD (H&L)	For use with PC3002
	PC3002 60-120-240G SANDPAPER 6PK WOOD (H&L)	Sands hardwood materials, softwood materials & metal
SCRAPING	SKU	APPLICATION
	PC3020 RIGID SCRAPER BLADE	Removes adhesive tiles, vinyl flooring & carpet. Scrapes paint, varnish or thinset
	PC3021 FLEXIBLE SCRAPER BLADE	Removes softer materials such as caulk & glue residue
GRINDING	SKU	APPLICATION
	PC3030 CARBIDE GROUT REMOVAL BLADE	Removes grout for tile replacement or repair

\* Battery & charger sold separately

# PORTER CABLE®

**20V** <sup>max+</sup>

***THE NEW POWER  
OF LITHIUM***



## PCCK600LB

### SPECIFICATIONS

VOLTS	20V MAX <sup>‡</sup>
BATTERY TYPE	Lithium Ion
CHUCK SIZE	1/2"
SPEED	0-400/0-1,600 RPM
MAX POWER	330 UWO
CLUTCH SETTINGS	23
WEIGHT	3.5 lbs.
INCLUDES	(2) PCC680L Lithium Ion compact batteries, (1) PCC690L Lithium Ion charger, (1) double-ended bit & (1) kit box



## 20V MAX<sup>‡</sup> Lithium Ion 1/4" Hex Impact Driver Kit

## PCCK640LB

### SPECIFICATIONS

VOLTS	20V MAX <sup>‡</sup>
BATTERY TYPE	Lithium Ion
CHUCK SIZE	1/4" HEX
TORQUE	1,450 in./lbs.
RPM	0-2,900
BPM	0-3,100
VARIABLE-SPEED TRIGGER	Yes
LENGTH	6.2"
WEIGHT	3.2 lbs.
INCLUDES	(2) PCC680L Lithium Ion compact batteries, (1) PCC690L Lithium Ion charger, (1) #2 PH screwdriving bit & (1) kit box



<sup>‡</sup> Maximum initial battery voltage (measured without a workload) is 20 volts. Nominal voltage is 18.

# BATTERIES & CHARGERS

## LITHIUM

### 12V MAX<sup>†</sup> Lithium Ion Battery

**PCL12BLX**

#### SPECIFICATIONS

VOLTS	12V MAX <sup>†</sup>
AMP HOUR	1.3
WEIGHT	0.4 lbs.



## LITHIUM

### 12V MAX<sup>†</sup> Lithium Ion Charger

**PCL12C**

#### SPECIFICATIONS

VOLTS	12V MAX <sup>†</sup>
CHARGE TIME	30 min.*



## LITHIUM

### 18V Lithium Ion EX Battery

**PC18BLEX**

#### SPECIFICATIONS

VOLTS	18V
AMP HOUR	2.6
WEIGHT	1.6 lbs.



## LITHIUM

### 18V Lithium Ion / NiCd Multi-Chemistry Fast Charger

**PCXMVC**

#### SPECIFICATIONS

VOLTS	18V
TYPE	NiCd or Lithium Ion
CHARGE TIME	30 minute - 1 hour



## LITHIUM

### 18V LX Lithium Ion Battery

**PC18BLX**

#### SPECIFICATIONS

VOLTS	18V
AMP HOUR	1.3
WEIGHT	1.0 lbs.



	BATTERY	CHARGE TIME
NiCd	PC18B	60 MINS.
LITHIUM	PC18BLX	30 MINS.*
	PC18BLEX	1 HOUR

### 18V NiCd Battery

**PC18B**

#### SPECIFICATIONS

VOLTS	18V
AMP HOUR	1.5
WEIGHT	2.0 lbs.



### 18V NiCd Battery Double Pack

**PC18B-2**

#### SPECIFICATIONS

VOLTS	18V
AMP HOUR	1.5
WEIGHT	2.0 lbs.



### 20V MAX<sup>‡</sup> Lithium Ion Battery

**PCC680L**

#### SPECIFICATIONS

VOLTS	20V MAX <sup>‡</sup>
AMP HOUR	1.5
WEIGHT	0.8 lbs.



### 20V MAX<sup>‡</sup> Lithium Ion Charger

**PCC690L**

#### SPECIFICATIONS

VOLTS	20V MAX <sup>‡</sup>
CHARGE TIME	40 min.



# CORDED



## 3A Oscillating Multi-Tool Kit with 31 Accessories







**PCE605K**

- 3.0 Amp Motor
- Tool-Free System Blade Change
- Depth and Cutting Guide

SPECIFICATIONS	
AMPS	3
OPM	10,000-22,000
OSCILLATING ANGLE	2.8 Degrees
WEIGHT	3.7 lbs.
INCLUDES	(1) depth/cutting guide, (1) wood/metal blade, (1) precision wood blade, (1) 1/2" segment wood/drywall blade, (1) sanding platen, (25) sand paper sheets, (1) flexible scraper & (1) kit box



### Available Accessories

CUTTING	SKU	APPLICATION
	PC3011 1-1/4" WOOD PLUNGE CUT BLADE	Finish cuts in plastic, hardwood & drywall such as door jambs, moulding & trim, PVC pipe & flooring
	PC3012 1-1/4" WOOD/METAL PLUNGE CUT BLADE (BI-METAL)	Finish cuts in plastic, hardwood, metal & drywall such as door jambs, moulding & trim, PVC/copper pipe, nails & flooring
	PC3013 4" FLUSH CUT BLADE (HSS)	Cuts openings in drywall, plywood, hardwood & flooring
SANDING	SKU	APPLICATION
	PC3005 SANDING PAD (H&L)	For use with PC3001, PC3002
	PC3002 60-120-240G SANDPAPER 6PK WOOD (H&L)	Sands hardwood materials, softwood materials & metal
SCRAPING	SKU	APPLICATION
	PC3021 FLEXIBLE SCRAPER BLADE	Removes softer materials such as caulk & glue residue

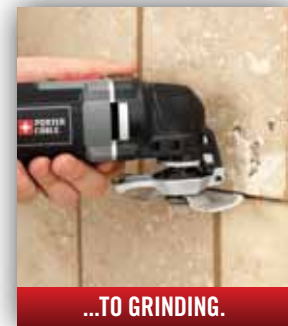
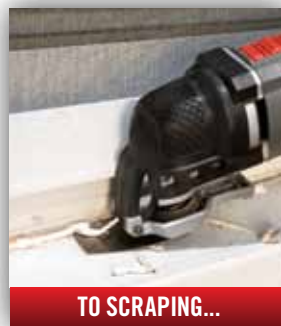
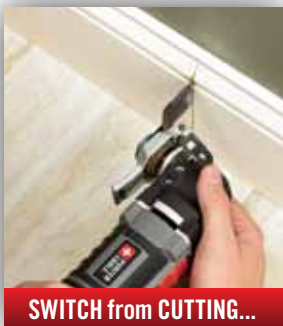

## 13A 7-1/4" Laser Circular Saw

### PC13CSL

- Heavy-Duty 13 Amp Motor
- Ball Bearing Construction
- Laser Guide
- Soft Grip Handle

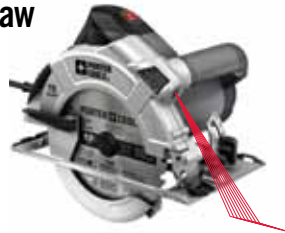

#### SPECIFICATIONS

VOLTS	120V AC only
AMPS	13
RPM	5,000
CUT CAPACITY	2-3/8" cutting capacity at 90 degrees
BEVEL CUT CAPACITY	1-13/16" cutting capacity at 45 degrees
INCLUDES	(1) wrench & (1) 7-1/4" 18T carbide blade

## 15A 7-1/4" Laser Circular Saw Kit

### PC15CSLK

- Heavy-Duty 15 Amp Motor
- Ball Bearing Construction
- Laser Guide
- Soft Grip Handle

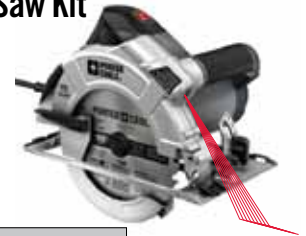

#### SPECIFICATIONS

VOLTS	120V AC only
AMPS	15
RPM	5,000
CUT CAPACITY	2-3/8" cutting capacity at 90 degrees
BEVEL CUT CAPACITY	1-13/16" cutting capacity at 45 degrees
INCLUDES	(1) wrench, (1) rip fence, (1) 7-1/4" 18T carbide blade & (1) storage bag

## 15A 7-1/4" Heavy-Duty Circular Saw Kit

### PC15TCSMK

- Heavy-Duty 15 Amp Motor
- Ball Bearing Construction
- Cast Magnesium Shoe
- 9.5 lb. Lightweight Saw
- 55 Degree Bevel Capacity with Stops at 22.5 & 45 Degrees



#### SPECIFICATIONS

VOLTS	120V AC only
AMPS	15
RPM	5,600
CUT CAPACITY	2-3/8" cutting capacity at 90 degrees
BEVEL CUT CAPACITY	1-13/16" cutting capacity at 45 degrees
INCLUDES	(1) wrench, (1) rip fence, (1) 7-1/4" 24T carbide tipped thin kerf framing blade & (1) kit box

## 4.5A 4-1/2" Trim Saw

### 314

- Rugged Worm Gear Drive
- 100% Ball Bearings
- Cuts 1-5/16" at 90 Degrees & 1-1/16" at 45 Degrees



#### SPECIFICATIONS

VOLTS	120V AC
AMPS	4.5
RPM	4,500
CUT CAPACITY	1-5/16" cutting capacity at 90 degrees
BEVEL CUT CAPACITY	1-1/16" cutting capacity at 45 degrees
INCLUDES	(1) 20T carbide-tipped riptide blade, (1) blade wrench & (1) knob

## 7.5A Reciprocating Saw

### PC75TRS

- Heavy-Duty 7.5 Amp Motor
- Easy Twist Tool-Free Blade Change
- Variable-Speed Trigger
- 1-1/8" Stroke Length
- Pivoting & Adjustable Shoe



#### SPECIFICATIONS

VOLTS	120V AC Only
AMPS	7.5
SPM	0-3,200
STROKE LENGTH	1-1/8"
INCLUDES	(1) 6" woodcutting blade

## 8.5A Orbital Reciprocating Saw

### PC85TRSOK **TIGERSAW™**

- Heavy-Duty 8.5 Amp Motor
- Orbital Action
- Easy Twist Tool-Free Blade Change
- Variable-Speed Trigger
- 1-1/8" Stroke Length
- Pivoting & Adjustable Shoe



#### SPECIFICATIONS

VOLTS	120V AC only
AMPS	8.5
SPM	0-3,200
STROKE LENGTH	1-1/8"
INCLUDES	(1) 6" woodcutting blade & (1) kit box

## 11.5A Reciprocating Saw

**9748 TIGERSAW™**

- Heavy-Duty 11.5 Amp Motor
- Electronic Variable-Speed
- 1-1/8" Stroke Length
- QUIK-CHANGE™ Blade Clamp
- QUIK-CHANGE™ Front Shoe



### SPECIFICATIONS

VOLTS	120V AC only
AMPS	11.5
SPM	0-2,600
STROKE LENGTH	1-1/8"

## 11.5A Variable Angle TIGERCLAW™

**9750 TIGERSAW™**

- Rear Gear Housing Adjusts
- 13 Positive Stop Locations
- Easy Twist Tool-Free Blade Change



### SPECIFICATIONS

VOLTS	120V AC only
AMPS	11.5
SPM	0-2,900
STROKE LENGTH	1-1/4"

## 6A Orbital Jigsaw

**PC600JS**

- Heavy-Duty 6 Amp Motor
- 7 Position Speed Dial
- 4 Orbital Settings
- Tool-Free Blade Clamp
- Tool-Free Bevel Adjustments at 0, 15, 30 & 45 Degrees
- Cast Aluminum Shoe with Protective Cover



### SPECIFICATIONS

VOLTS	120V AC only
AMPS	6
SPM	0-3,200
STROKE LENGTH	13/16"
INCLUDES	(1) woodcutting blade, & (1) shoe cover

## 6A 3/8" VSR Drill

**PC600D**

- Heavy-Duty 6 Amp Motor
- 0-2,500 RPM Variable-Speed Trigger
- Integral Belt Clip



### SPECIFICATIONS

VOLTS	120V AC only
AMPS	6
RPM	0-2,500
CAPACITY	1" Wood 3/8" Metal

## 7A 1/2" VSR Drill

**PC700D**

- Heavy-Duty 7 Amp Motor
- 0-800 RPM Variable-Speed Trigger
- Cast Metal Gear Housing
- 360 Degree Side Handle



### SPECIFICATIONS

VOLTS	120V AC only
AMPS	7
RPM	0-800
CAPACITY	1-1/2" wood 1/2" metal
INCLUDES	(1) chuck & key, (1) cast metal side handle

## 7A 1/2" VSR 2-Speed Hammerdrill

**PC70THD**

- Heavy-Duty 7 Amp Motor
- 2 Speed Settings (0-1,100 / 0-3,100 RPM)
- Dual Mode — Hammer & Drill
- Cast Metal Gear Housing
- Overmold Pistol Grip Handle
- 360 Degree Side Handle



### SPECIFICATIONS

VOLTS	120V AC only
AMPS	7
RPM	0-1,100/0-3,100
BPM	52,700
CAPACITY	1-1/4" Wood 1/2" Steel & Concrete
INCLUDES	(1) side handle, (1) chuck & key

## 6A Hand Planer

### PC60THPK

- Heavy-Duty 6 Amp Motor
- 11.5" Cast Aluminum Base
- Dual Sided Dust Extraction
- Uses Carbide or HSS Blades



#### SPECIFICATIONS

VOLTS	120V AC only
AMPS	6
RPM	16,500
MAX DEPTH OF CUT	5/64"
MAX RABBIT DEPTH	15/32"
INCLUDES	(2) carbide cutting blades, (2) HSS cutting blades, (1) wrench, (1) dust bag, (1) edge guide, (1) vac adaptor, (1) kitbox



## 1500 Watt Heat Gun

### PC1500HG

- Dual Speed Fan Selector
- Integral Hands Free Support Stand
- Variable Temperature Control Dial
- Integral Hang Hook



#### SPECIFICATIONS

VOLTS	120V AC only
WATTS	1500
TEMPERATURE	120-1150 degrees
MAX CFM	19
WEIGHT	2.0 lbs.
INCLUDES	(1) fan nozzle

## 6A 4-1/2" Angle Grinder

### PC60TAG

- Durable 6 Amp Motor
- Cast Metal Gear Housing
- 3-Position Adjustable Side Handle
- Slide Switch



#### SPECIFICATIONS

VOLTS	120V AC only
AMPS	6
RPM	11,000
SPINDLE	5/8"-11
INCLUDES	(1) 4-1/2" grinding wheel, (1) grinding wheel guard, (1) wrench & (1) side handle



## 7A 4-1/2" Angle Grinder / Cut Off Tool

### PC60TPAG

- Durable 7 Amp Motor
- Cast Metal Gear Housing
- 3-Position Adjustable Side Handle
- Paddle Switch



#### SPECIFICATIONS

VOLTS	120V AC only
AMPS	7
RPM	11,000
SPINDLE	5/8"-11
INGREDIENTS	(1) 4-1/2" grinding guard, (1) grinding wheel, (1) cutting guard, (1) cutting wheel, (1) wrench & (1) side handle



## 7.5A 4-1/2" Small Angle Grinder

### PC750AG

- Durable 7.5 Amp Motor
- Cast Metal Gear Case
- 3-Position Side Handle
- Rear Handle Switch



#### SPECIFICATIONS

VOLTS	120V AC only
AMPS	7.5
RPM	10,000
SPINDLE	5/8"-11
INCLUDES	(1) 4-1/2" grinding wheel, (1) grinding wheel guard, (1) wrench & (1) side handle



# PORTER CABLE®

## FASTENING TOOLS



# COMPRESSORS & FASTENERS

## 150 PSI Max, 1.5 Gal. Oil-Free Fully Shrouded Compressor

### CMB15

- 2.0 SCFM\* @ 90 PSI Max Allows for Quick Compressor Recovery Time
- 1.5 Gal. Tank in Shroud is Easy to Carry, Includes Water Drain Valve & Rubber Feet
- 150 PSI Max Tank Pressure Stores More Air in The Tank for Longer Tool Runtime
- Durable Oil-Free Pump for Long Life & No Maintenance
- Low Amp 120V Motor Starts Easily in Cold Weather or With Extension Cord
- Low Noise At 79 dBA\*\* for a Quieter Work Environment
- Only 20 lbs. for Easy Portability
- Fully Enclosed Design Provides Protection from Hot or Moving Parts
- 25' Coil Hose & 8 Pc Accessory Kit Facilitate a Number of Inflation Tasks



SPECIFICATIONS	
CUT-OUT MAX	150 PSI
CUT-IN RESTART	120 PSI
AIR DELIVERY @ 40 PSI ISO1217	3.0 SCFM
AIR DELIVERY @ 90 PSI ISO1217	2.0 SCFM
TANK SIZE	1.5 Gal.
RUNNING HORSEPOWER	0.8 HP
VOLTAGE	120 V
AMPS	10 Amps
PUMP LUBRICATION	Oil-Free Pump
DECIBEL ISO3744	79 dBA
REGULATOR	Yes
GAUGES	2
QUICK-CONNECT COUPLERS	0
PRODUCT WEIGHT	20 lbs.
SHIPPING WEIGHT	24 lbs.

## 135 PSI Max, 1 Gal. Heavy-Duty Quiet Trim Compressor

### C1010

- 0.75 SCFM\* Delivered At 90 PSI Max, 1 Gallon Tank & 135 PSI Max Enables Surge Performance With Quick Recovery
- Durable, Long Life Maintenance Free Pump for Ease of Use
- Low Amp 120V Motor Starts Easily in Cold Weather or With Extension Cord
- Low 71dBA\*\* for Quiet Operation, 2.6 Amp Draw for Easy Start up & Reduced Breaker Tripping
- Light Weight (23 lbs.) Compact Design (9" Tall) is Easy to Carry & Store
- High-Flow Regulator for Maximum Performance
- Ball Drain Valve Allows for Quick & Thorough Tank Draining
- Roll Cage & Control Panel Provide Protection to Key Compressor Components
- Convenient Cord Wrap for Easy Storage



SPECIFICATIONS	
CUT-OUT MAX	135 PSI
CUT-IN RESTART	105 PSI
AIR DELIVERY @ 90 PSI ISO1217	0.75 SCFM
TANK SIZE	1 Gal.
RUNNING HORSEPOWER	0.3 HP
VOLTAGE	120 V
AMPS	3.5 Amps
PUMP LUBRICATION	Oil-Free Pump
DECIBEL ISO3744	71.5 dBA
REGULATOR	1
GAUGES	2
QUICK-CONNECT COUPLERS	1
PRODUCT WEIGHT	24 lbs.
SHIPPING WEIGHT	29 lbs.

\*Tested Per ISO 1217

\*\*Tested Per ISO 3744

## C2002 150 PSI Max, 6 Gal. Oil-Free Pancake Compressor

### C2002-WK 150 PSI Max, 6 Gal. Oil-Free Pancake Compressor with 13 Piece Kit

#### SHARED FEATURES

- 2.6 SCFM\* @ 90 PSI Allows for Quick Compressor Recovery Time
- 6 Gal. Pancake Style Tank for Stability, Includes Water Drain Valve & Rubber Feet
- 150 PSI Max Tank Pressure Stores More Air in The Tank for Longer Tool Runtimes
- Durable Oil-Free Pump for Long Life & No Maintenance
- Low Amp 120V Motor Starts Easily in Cold Weather or With Extension Cord
- Only 30 lbs. for Easy Portability
- Two Regulated, Factory Installed Air Couplers to Easily Support Two Users
- Shroud, Handle & Console Cover Protects Vital Components, Makes Unit Easier to Carry & Includes Cord Wrap

SPECIFICATIONS	
CUT-OUT MAX	150 PSI
CUT-IN RESTART	120 PSI
AIR DELIVERY @ 40 PSI ISO1217	3.3 SCFM
AIR DELIVERY @ 90 PSI ISO1217	2.6 SCFM
TANK SIZE	6 Gal.
RUNNING HORSEPOWER	0.8 HP
VOLTAGE	120 V
AMPS	10 Amps
PUMP LUBRICATION	Oil-Free Pump
DECIBEL ISO3744	75.5 dBA
REGULATOR	Yes
GAUGES	2
QUICK-CONNECT COUPLERS	2
PRODUCT WEIGHT	30 lbs.
SHIPPING WEIGHT	34 lbs.-C2002 35 lbs.-C2002-WK

#### MODEL #

#### UNIQUE TOOL FEATURES

C2002-WK

- Accessory Kit- 25' X 1/4" PVC Air Hose With Coupler & Plug Assembled, Tire Chuck With Plug Assembled, Blow Gun With Plug Assembled, Tire Gauge, OSHA Safety Nozzle & Four Inflator Adapters



## C2004-WK 165 PSI Max, 4 Gal. Oil-Free Pancake Compressor with 25' PU Hose and Fittings

- 2.6 SCFM\* @ 90 PSI for Fast Recovery Time
- 165 PSI Max Pressure, 4 Gal. Tank for Longer Tool Runtimes in a More Compact, Lighter Design
- Oil-Free Pump for No Oil Spills/Contamination & Maintenance-Free Operation
- Low Amp 120V Motor Starts Easily in Cold Weather or With Extension Cord
- 75.5 dBA\*\* for a Quieter Work Environment
- Only 29 lbs. for Easy Portability
- Two Regulated, Factory Installed Air Couplers to Easily Support Two Users
- Shroud Includes Heavy-Duty Handle, Cord Wrap & Console Cover to Make Unit Easy to Carry, Manage Cord & Protect Vital Components
- 25' X 1/4" Thick Red Polyurethane Hose (With Factory Installed Coupler & Plug) for Light Weight, Abrasion Resistance, Flexibility & High Visibility

SPECIFICATIONS	
CUT-OUT MAX	165 PSI
CUT-IN RESTART	135 PSI
AIR DELIVERY @ 40 PSI ISO1217	3.3 SCFM
AIR DELIVERY @ 90 PSI ISO1217	2.6 SCFM
TANK SIZE	4 Gal.
RUNNING HORSEPOWER	0.8 HP
VOLTAGE	120 V
AMPS	10 Amps
PUMP LUBRICATION	Oil-Free Pump
DECIBEL ISO3744	75.5 dBA
REGULATOR	Yes
GAUGES	2
QUICK-CONNECT COUPLERS	2
PRODUCT WEIGHT	29 lbs.
SHIPPING WEIGHT	34 lbs.



SKU #	GAUGE	TYPE	LENGTH	QTY
PBN18063	18	BRAD NAILS	5/8"	5000
PBN18063-1	18	BRAD NAILS	5/8"	1000
PBN18075	18	BRAD NAILS	3/4"	5000
PBN18075-1	18	BRAD NAILS	3/4"	1000
PBN18100	18	BRAD NAILS	1"	5000
PBN18100-1	18	BRAD NAILS	1"	1000
PBN18125	18	BRAD NAILS	1-1/4"	5000
PBN18125-1	18	BRAD NAILS	1-1/4"	1000
PBN18150	18	BRAD NAILS	1-1/2"	5000
PBN18175	18	BRAD NAILS	1-3/4"	5000
PBN18200	18	BRAD NAILS	2"	5000
PBN18200-1	18	BRAD NAILS	2"	1000
BN18PP	18	BRAD NAILS	3/4", 1-1/4", 2"	900
PDA15100	15	D/A FINISH NAILS	1"	4000
PDA15100-1	15	D/A FINISH NAILS	1"	1000
PDA15125	15	D/A FINISH NAILS	1-1/4"	4000
PDA15125-1	15	D/A FINISH NAILS	1-1/4"	1000
PDA15150	15	D/A FINISH NAILS	1-1/2"	4000
PDA15150-1	15	D/A FINISH NAILS	1-1/2"	1000
PDA15175	15	D/A FINISH NAILS	1-3/4"	4000
PDA15175-1	15	D/A FINISH NAILS	1-3/4"	1000
PDA15200	15	D/A FINISH NAILS	2"	4000
PDA15200-1	15	D/A FINISH NAILS	2"	1000
PDA15200G	15	D/A FINISH NAILS GALVANIZED	2"	4000
PDA15250	15	D/A FINISH NAILS	2-1/2"	4000
PDA15250-1	15	D/A FINISH NAILS	2-1/2"	1000
PDA15250G	15	D/A FINISH NAILS GALVANIZED	2-1/2"	4000
PDA15250G-1	15	D/A FINISH NAILS GALVANIZED	2-1/2"	1000
PDA15150-2	15	D/A FINISH NAILS	1-1/2"	2500
PDA15200-2	15	D/A FINISH NAILS	2"	2500
PDA15200G-2	15	D/A FINISH NAILS GALVANIZED	2"	2500
PDA15250-2	15	D/A FINISH NAILS	2-1/2"	2500
PDA15250G-2	15	D/A FINISH NAILS GALVANIZED	2-1/2"	2500
PFN16100	16	FINISH NAILS	1"	2500
PFN16100-1	16	FINISH NAILS	1"	1000
PFN16125	16	FINISH NAILS	1-1/4"	2500

SKU #	GAUGE	TYPE	LENGTH	QTY
PFN16125-1	16	FINISH NAILS	1-1/4"	1000
PFN16150	16	FINISH NAILS	1-1/2"	2500
PFN16150-1	16	FINISH NAILS	1-1/2"	1000
PFN16175	16	FINISH NAILS	1-3/4"	2500
PFN16200	16	FINISH NAILS	2"	2500
PFN16200-1	16	FINISH NAILS	2"	1000
PFN16250	16	FINISH NAILS	2-1/2"	2500
PFN16250-1	16	FINISH NAILS	2-1/2"	1000
FN16PP	16	FINISH NAILS	1-1/4", 2", 2-1/2"	900
PPH23063	23	SLIGHT HEAD PINS	5/8"	2000
PPH23075	23	SLIGHT HEAD PINS	3/4"	2000
PPH23100	23	SLIGHT HEAD PINS	1"	2000
PPH23125	23	SLIGHT HEAD PINS	1-1/4"	2000
PPH23138	23	SLIGHT HEAD PINS	1-3/8"	2000
PPN23050	23	HEADLESS PINS	1/2"	2000
PPN23063	23	HEADLESS PINS	5/8"	2000
PPN23075	23	HEADLESS PINS	3/4"	2000
PPN23100	23	HEADLESS PINS	1"	2000
PPN23125	23	HEADLESS PINS	1-1/4"	2000
PPN23138	23	HEADLESS PINS	1-3/8"	2000
PN23PP	23	HEADLESS PINS	1/2", 3/4", 1"	900
PNS18050	18	1/4" CROWN STAPLES	1/2"	5000
PNS18063	18	1/4" CROWN STAPLES	5/8"	5000
PNS18075	18	1/4" CROWN STAPLES	3/4"	5000
PNS18088	18	1/4" CROWN STAPLES	7/8"	5000
PNS18088-1	18	1/4" CROWN STAPLES	7/8"	1000
PNS18100	18	1/4" CROWN STAPLES	1"	5000
PNS18100-1	18	1/4" CROWN STAPLES	1"	1000
PNS18125	18	1/4" CROWN STAPLES	1-1/4"	5000
PNS18125-1	18	1/4" CROWN STAPLES	1-1/4"	1000
PNS18150	18	1/4" CROWN STAPLES	1-1/2"	5000
NS18PP	18	1/4" CROWN STAPLES	1/2", 3/4", 1"	900
PUS12G	22	3/8" CROWN UPHOLSTRY STAPLES	1/2"	10,000
PUS38G	22	3/8" CROWN UPHOLSTRY STAPLES	3/8"	10,000
PUS58G	22	3/8" CROWN UPHOLSTRY STAPLES	5/8"	10,000

## 18 Ga. 2" Brad Nailer Kit

### BN200C

- Long Life Maintenance-Free Motor to Keep From Staining the Work Surface
- Tool-Free Depth-Of-Drive Adjustment With Detents for Proper Setting of Nail Heads
- Tool-Free Jam Release Mechanism for Easy Nail Removal
- Rear Exhaust to Keep Contaminates Away From Work
- Drives 18 Ga. Nails from 5/8" to 2" Length
- Magnesium Body Delivers Strong & Lightweight Design



SPECIFICATIONS	
MAGAZINE CAPACITY	100 NAILS
FIRING MODES	Sequential Fire
JAM CLEARANCE	Front Opening Quick Release
OPERATING PRESSURE	70 – 120 PSI
FASTENER TYPE	18 Ga. Finish Nails
FASTENER RANGE	5/8" to 2"
LENGTH	9.5"
HEIGHT	9.5"
PRODUCT WEIGHT	2.6 lbs.
SHIPPING WEIGHT	6.2 lbs.

## 16 Ga. 2-1/2" Finish Nailer Kit

### FN250C

- Maintenance-Free Motor Designed to Deliver Long Life
- Internal Piston Catch for Consistent Max Power on Every Shot
- Tool-Free Depth-Of-Drive Adjustment With Detents for Proper Setting of Nail Heads
- Drives 16 Ga. "FN" Style Finish Nails from 1" to 2-1/2" Length
- Tool-Free Jam Release Mechanism for Easy Nail Removal



SPECIFICATIONS	
MAGAZINE CAPACITY	100 Nails
FIRING MODES	Sequential Fire
JAM CLEARANCE	Front Opening Quick Release Nose
OPERATING PRESSURE	70 – 120 PSI
FASTENER TYPE	16 Ga. Finish Nails
FASTENER RANGE	1" to 2-1/2"
LENGTH	11.8"
HEIGHT	10.6"
PRODUCT WEIGHT	3.85 lbs.
SHIPPING WEIGHT	10.07 lbs.

## 15 Ga. 2-1/2" Angle Finish Nailer Kit

### DA250C

- Maintenance-Free Motor Designed to Deliver Long Life
- Internal Piston Catch for Consistent Max Power on Every Shot
- Tool-Free Depth-Of-Drive Adjustment With Detents for Proper Setting of Nail Heads
- Drives 15 Ga. "DA" Style Angle Finish Nails from 1" to 2-1/2" Length
- Tool-Free Jam Release Mechanism for Easy Nail Removal



SPECIFICATIONS	
MAGAZINE CAPACITY	100 Nails
FIRING MODES	Sequential Fire
JAM CLEARANCE	Front Opening Quick Release Nose
OPERATING PRESSURE	70 – 120 PSI
FASTENER TYPE	15 Ga. "DA" Angle Finish Nails
FASTENER RANGE	1" to 2-1/2"
LENGTH	13"
HEIGHT	11.5"
PRODUCT WEIGHT	3.85 lbs.
SHIPPING WEIGHT	10.55 lbs.

## 18 Ga. 1-1/2" Narrow Crown Stapler Kit

### NS150C

- Long Life Maintenance-Free Motor to Keep from Staining the Work Surface
- Tool-Free Depth-Of-Drive Adjustment With Detents for Proper Setting of Staples
- Rear Exhaust to Keep Contaminates Away from Work
- Drives 18 Ga. Staples With 1/4" Crown from 1/2" to 1-1/2" Length
- Split Nose Design for Easy Removal of Jammed Staples
- Magnesium Body Delivers Strong & Lightweight Design



SPECIFICATIONS	
MAGAZINE CAPACITY	100 Nails
FIRING MODES	Sequential Fire
JAM CLEARANCE	Split Nose Design
OPERATING PRESSURE	70 – 120 PSI
FASTENER TYPE	18 Ga. 1/4" Crown Staple
FASTENER RANGE	1/2" to 1-1/2"
LENGTH	9.3"
HEIGHT	9.8"
PRODUCT WEIGHT	2.8 lbs.
SHIPPING WEIGHT	6.8 lbs.

## 23 Ga. 1-3/8" Pin Nailer Kit

### PIN138

- Uses 23 Ga. Headless & Slight Head Pin Nails from 5/8" to 1-3/8" Length
- Long Life Maintenance-Free Motor to Keep from Staining The Work Surface
- Consistent Power & Penetration to Sink 1-3/8" Nail Sub-Flush Into Oak
- Rear Exhaust to Keep Contaminates Away from Work
- Dry-Fire Lock-Out Alerts User to Re-Load Nails & Eliminates Empty Nail
- Includes: Nailer, 2000 Pin Nails of 3/4", 1/4" Plug With Cap, Wrench, & Carrying Case



SPECIFICATIONS	
MAGAZINE CAPACITY	130 pins
FIRING MODES	Dual Trigger feature
OPERATING PRESSURE	60 – 100 PSI
FASTENER TYPE	23 Ga. Headless and Slight Head Pin Nails
FASTENER RANGE	5/8" to 1-3/8"
LENGTH	9.5"
HEIGHT	7.5"
PRODUCT WEIGHT	2.2 lbs.
SHIPPING WEIGHT	4.25 lbs.

## 22 Ga. 3/8" Upholstery Stapler

### US58

- Uses Standard SENCO® "C" Type, 22 Ga. 3/8" Crown Staples from 1/4" to 5/8" Long
- Small & Lightweight for Ease of Operation
- 1" Nose Extension for Limited Clearance Fastening
- Steel Top Cap for Durability
- Rear Exhaust Port Channels Air & Tool Oil/Condensation Away from User



SPECIFICATIONS	
MAGAZINE CAPACITY	185 Staples
FIRING MODES	Trigger
OPERATING PRESSURE	70 – 120 PSI
FASTENER TYPE	22 Ga. 3/8" Crown Staple
FASTENER RANGE	1/4" to 5/8"
LENGTH	6"
HEIGHT	9"
PRODUCT WEIGHT	2 lbs.
SHIPPING WEIGHT	2.725 lbs.

## Paper Tape Framing Nailer

### FC350B

- Lightweight at just 7.3 lbs
- Power to Drive Nails (Up to 3-1/2" X .131"), into Engineered Lumber
- Selectable Trigger with Trigger Lockout for Restrictive or Contact Actuation Mode
- Tool-Free Adjustable Depth-of-Drive for Proper Setting of Nail Heads
- Reversible Rafter Hook for Hanging Tool on Left or Right Side
- Low Nail Lockout Indicates When to Reload Tool



SPECIFICATIONS	
MAGAZINE CAPACITY	80 Nails
FIRING MODES	Sequential and Contact Modes
OPERATING PRESSURE	70 – 120 PSI
FASTENER TYPE	30° - 33° Plastic
FASTENER RANGE	2" to 3-1/2" x .113" to .131"
LENGTH	18.4"
HEIGHT	14.25"
PRODUCT WEIGHT	7.3 lbs.
SHIPPING WEIGHT	15.25 lbs.

## Plastic Collated Framing Nailer

### FR350B

- Lightweight at just 7.3 lbs
- Power to Drive Nails (Up to 3-1/2" X .131") into Engineered Lumber
- Selectable Trigger with Trigger Lockout
- Tool-Free Adjustable Depth-of-Drive for Proper Setting of Nail Heads
- Reversible Rafter Hook for Hanging Tool on Left or Right Side
- Low Nail Lockout Indicates When to Reload Tool



SPECIFICATIONS	
MAGAZINE CAPACITY	64 Nails
FIRING MODES	Sequential and Contact Modes
OPERATING PRESSURE	70 – 120 PSI
FASTENER TYPE	21° Plastic
FASTENER RANGE	2" to 3-1/2" x .113" to .148"
LENGTH	19.5"
HEIGHT	14.25"
PRODUCT WEIGHT	7.3 lbs.
SHIPPING WEIGHT	15.25 lbs.

## Roofing Nailer

### RN175B

- Compact Body Design is 5% Lighter\* for Improved Balance & Control
- Tool-Free Adjustable Shingle Guide for Accurate Shingle Placement
- Selectable Trigger for Easy Change Between Sequential & Contact Mode
- Quick-Set Depth-of-Drive Helps Prevent Shingle Damage
- Skid-Resistant Pads/Wear Guards for Safety & Tool Protection
- Over-Molded Grip for Comfort & Control



SPECIFICATIONS	
MAGAZINE CAPACITY	120 Nails
FIRING MODES	Sequential and Contact Modes
OPERATING PRESSURE	70 – 120 PSI
FASTENER TYPE	15 Degree Wire Weld Roofing Nails
FASTENER RANGE	3/4" to 1-3/4" x .120
LENGTH	10.24"
HEIGHT	10.63"
PRODUCT WEIGHT	4.78 lbs.
SHIPPING WEIGHT	4.78 lbs.

## 16 Ga. Medium Crown Stapler Kit

### MS200

- Drives Senco Type “N” Wire 16 Ga. 7/16” Crown Staples from 1” to 2” Long
- Powerful Piston With TEFLON® Ring Design That Prevents Cylinder Bore Scuffing – Lasts Far Longer Than Conventional “O” Rings
- Tool-Free Adjustable Exhaust
- Open Top-Load Hard Coat Anodized Magazine With Push-Button Follower Accommodates Two 70-Staple Strips or Three 50-Staple Strips
- Selectable Trigger – Restrictive or Contact Actuation Mode



SPECIFICATIONS	
MAGAZINE CAPACITY	150 Staples
FIRING MODES	Selectable Trigger restrictive or contact actuation mode
JAM CLEARANCE	Lever Type Quick Release Nose
OPERATING PRESSURE	70 – 120 PSI
FASTENER TYPE	16 Ga. 7/16” Crown Staple
FASTENER RANGE	1” to 2”
LENGTH	14.125”
HEIGHT	10.75”
PRODUCT WEIGHT	5.875 lbs.
SHIPPING WEIGHT	10.55 lbs.

## Palm Nailer Kit

### PN650

- Capacity from 1-1/4” to 6-1/2” (3D to 70D)
- Comes With Four Different Nose Tips
  - “No Mar” Finish Tip: for Finish Nail up to 3D
  - Magnetic Tip: for Driving 3D to 16D Common Nails
  - Standard Tip: for Common Nails up to 70D
  - Steel Hammer Tip: for Mouldings, Dowels, & Automotive Body Work



SPECIFICATIONS	
FIRING MODES	Multi Blow 2300 BPM@100 PSI
OPERATING PRESSURE	50 – 120 PSI
FASTENER RANGE	1-1/4” to 6-1/2”
LENGTH	4.5”
HEIGHT	5”
PRODUCT WEIGHT	2.5 lbs.
SHIPPING WEIGHT	6 lbs.

## Mini Palm Nailer

### PN350

- Compact, Lightweight Design Convenient for Tight Spaces & Storage
- Accurate Nail Placement for Precision Applications such as Fastening Joist Hangers
- Front Exhaust Directs Air Away from Users Palm



SPECIFICATIONS	
FIRING MODES	Multi Blow Impact
OPERATING PRESSURE	80 – 100 PSI
FASTENER RANGE	Bulk Nails
LENGTH	5.25”
HEIGHT	4”
PRODUCT WEIGHT	1 lbs.
SHIPPING WEIGHT	7.2 lbs.



## Brad Nailer Compressor Combo Kit

### PCFP12236

- Shroud, Handle & Console Cover Protects Vital Components, Makes Unit Easier to Carry and Includes Cord Wrap
- 150 PSI Max Allows User to Drive More Nails than a Traditional 135 PSI Max Compressor
- 6 Gal. Tank Allows Users to Drive a Large Quantity of Nails on a Single Tank Charge
- 2.6 SCFM @ 90 PSI Allows for Quick Compressor Recovery Time, Per ISO1217
- 30 lbs Weight Allows Compressor to be Easily Carried
- Uses Standard 18 Ga. Brad Nails from 5/8"– 2"
- Maintenance-Free Pump for Convenient Operation



SPECIFICATIONS	
CUT-OUT MAX	150 PSI
CUT-IN RESTART	120 PSI
AIR DELIVERY @ 40 PSI ISO1217	3.5 SCFM
AIR DELIVERY @ 90 PSI ISO1217	2.6 SCFM
TANK SIZE	6 Gal.
RUNNING HORSEPOWER	0.8 HP
VOLTAGE	120 V
AMPS	10 Amps
PUMP LUBRICATION	Oil-Free Pump
DECIBEL ISO3744	78 dBA
REGULATOR	Yes
GAUGES	18 Ga. Brad
QUICK-CONNECT COUPLERS	2
NUMBER of TOOLS in KIT	1
PRODUCT WEIGHT	30 lbs.
SHIPPING WEIGHT	42 lbs.

## Finish Nailer/Brad Nailer Compressor Combo Kit

### PCFP12656

- Shroud, Handle & Console Cover Protects Vital Components, Makes Unit Easier to Carry and Includes Cord Wrap
- 150 PSI Max Allows User to Drive More Nails than a Traditional 135 PSI Max Compressor
- 6 Gal. Tank Allows Users to Drive a Large Quantity of Nails on a Single Tank Charge
- 2.6 SCFM @ 90 PSI Allows for Quick Compressor Recovery Time, Per ISO1217
- 30 lbs Weight Allows Compressor to be Easily Carried
- BN200C: Uses Standard 18 Ga. Brad Nails from 5/8" – 2"
- FN250C: Uses Standard Straight 16 Ga. Finish Nails from 1" - 2-1/2"
- Maintenance-Free Pump for Convenient Operation



SPECIFICATIONS	
CUT-OUT MAX	150 PSI
CUT-IN RESTART	120 PSI
AIR DELIVERY @ 40 PSI ISO1217	3.5 SCFM
AIR DELIVERY @ 90 PSI ISO1217	2.6 SCFM
TANK SIZE	6 Gal.
RUNNING HORSEPOWER	0.8 HP
VOLTAGE	120 V
AMPS	10 Amps
PUMP LUBRICATION	Oil-Free Pump
DECIBEL ISO3744	78 dBA
REGULATOR	Yes
GAUGES	18 Ga. Brad, 18 Ga. Stapler
QUICK-CONNECT COUPLERS	2
NUMBER of TOOLS in KIT	2
PRODUCT WEIGHT	30 lbs.
SHIPPING WEIGHT	50 lbs.

## Finish Nailer/Brad Nailer/Stapler Compressor Combo Kit

### PCFP12234

- 6 Gal. Tank Allows Users to Drive a Large Quantity of Nails on a Single Tank Charge
- 2.6 SCFM @ 90 PSI Allows for Quick Compressor Recovery Time, Per ISO1217
- 30 lbs Weight Allows Compressor to be Easily Carried
- Shroud, Handle & Console Cover Protects Vital Components, Makes Unit Easier to Carry & Includes Cord Wrap
- 150 PSI Max Allows User to Drive More Nails than a Traditional 135 PSI Max Compressor
- BN200C: Uses Standard 18 Ga. Brad Nails from 5/8" - 2"
- NS150C: Uses 18 Ga., 1/4" Crown Staples from 1/2" – 1-1/2"
- FN250C: Uses Standard Straight 16 Ga. Finish Nails from 1"– 2-1/2"
- Maintenance-Free Pump for Convenient Operation



SPECIFICATIONS	
CUT-OUT MAX	150 PSI
CUT-IN RESTART	120 PSI
AIR DELIVERY @ 40 PSI ISO1217	3.5 SCFM
AIR DELIVERY @ 90 PSI ISO1217	2.6 SCFM
TANK SIZE	6 Gal.
RUNNING HORSEPOWER	0.8 HP
VOLTAGE	120 V
AMPS	10 Amps
PUMP LUBRICATION	Oil-Free Pump
DECIBEL ISO3744	78 dBA
REGULATOR	Yes
GAUGES	18 Ga. Brad 18 Ga. Staple 18 Ga. Finish
QUICK-CONNECT COUPLERS	2
NUMBER of TOOLS in KIT	3
PRODUCT WEIGHT	30 lbs.
SHIPPING WEIGHT	55 lbs.

## 2-1/2" Finish Nailer Compressor Combo Kit

### PC1PAK

- Innovative Shroud Allows for Better Protection & Portability
- 150 PSI Max Allows Users to Drive More Nails Than a Traditional 135 Max PSI Compressor
- 6 Gal. Tank Allows Users to Drive a Large Quantity of Nails on a Single Tank Charge
- FN250C Uses Standard 16 Ga. Finish Nails from 1" to 2-1/2" Long
- Maintenance-Free Motor Designed to Deliver Long Life



SPECIFICATIONS	
CUT-OUT MAX	150 PSI
CUT-IN RESTART	120 PSI
AIR DELIVERY @ 40 PSI ISO1217	3.5 SCFM
AIR DELIVERY @ 90 PSI ISO1217	2.6 SCFM
TANK SIZE	6 Gal.
RUNNING HORSEPOWER	0.8 HP
VOLTAGE	120 V
AMPS	10 Amps
PUMP LUBRICATION	Oil-Free Pump
DECIBEL ISO3744	82 dBA
REGULATOR	Yes
GAUGES	16 Ga. Finish
QUICK-CONNECT COUPLERS	2
NUMBER of TOOLS in KIT	1
PRODUCT WEIGHT	34 lbs.
SHIPPING WEIGHT	45 lbs.



# PORTER CABLE®

## ACCESSORIES

Visit [portercable.com](http://portercable.com) for full product listing







# SERVICE CENTERS

## PORTER-CABLE FACTORY OWNED SERVICE CENTERS

CITY/STATE/ZIP	ADDRESS	AREA	PHONE	CITY/STATE/ZIP	ADDRESS	AREA	PHONE
<b>ALABAMA</b>							
Birmingham, 35209.....	321 Valley Ave - Suite B	205	942-0538	Las Vegas, 89118.....	5565 South Decatur Blvd - Suite 103	702	889-6025
Mobile, 36693 .....	732 Lakeside Drive	251	602-1000	<b>NEW JERSEY</b>			
<b>ALASKA</b>							
Anchorage, 99503 .....	4831 Old Seward Hwy - Suite 103	907	561-7181	Elmwood Park, 07407 .....	213 Route 46 W. - Suite 4	201	475-3524
<b>ARIZONA</b>							
Phoenix, 85040.....	4001 East Bdwy - Suite B-11	602	437-1200	<b>NEW MEXICO</b>			
<b>ARKANSAS</b>							
North Little Rock, 72113 ....	9600 Maumelle Blvd	501	372-3040	Albuquerque, 87110-3233..	5617 Menaul Blvd N.E.	505	884-1002
<b>CALIFORNIA</b>							
San Diego, 92111 .....	7290 Clairemont Mesa Blvd	858	279-2011	<b>NEW YORK</b>			
Hayward, 94545 .....	2512 Tripaldi Way	510	783-3959	Buffalo, 14209-1297 .....	881 West Delavan Ave	716	884-6220
Anaheim, 92806 .....	1119 North Kraemer Blvd	714	414-0369	Woodside, 11377-4741 .....	56-15 Queens Blvd	718	335-1042
North Highlands, 95660.....	4986 Watt Ave - Suite B	916	344-3520	Rochester, 14623-2594.....	2969 West Henrietta Rd	585	424-1310
Ontario, 91761 .....	1352 South Grove Ave - Suite B	909	930-1437	Happauge, 11788 .....	180 Oser Ave - Suite 100	631	952-2008
<b>COLORADO</b>							
Denver, 80223 .....	700 West Mississippi Ave - Unit B1	303	922-8325	Latham, 12110-2497 .....	836 Troy-Schenectady Rd	518	785-1867
<b>CONNECTICUT</b>							
Wethersfield, 06109-3001..	662 Silas Deane Hwy	860	563-5800	<b>NORTH CAROLINA</b>			
<b>FLORIDA</b>							
Davie, 33314 .....	4343 South State Rte 7 - Unit 107	954	321-6635	Charlotte, 28208 .....	3557-B Wilkinson Blvd	704	392-0245
Tampa, 33634.....	4909 West Waters Ave	813	884-0434	Greensboro, 27407.....	3402 West Wendover Ave - Suite E	336	852-1300
Jacksonville, 32205-4898..	920 Cassat Ave	904	781-2253	Raleigh, 27604-3235 .....	2930 Capital Blvd	919	878-0357
Orlando, 32807 .....	6100 Hanging Moss Rd - Suite 520	407	657-0474	<b>OHIO</b>			
West Palm Beach, 33415 ..	4645 Gun Club Rd - Suite 27	561	689-3247	Parma, 44130 .....	12100 Snow Rd - Suite 2	440	842-9100
<b>GEORGIA</b>							
Norcross, 30071.....	6115-C Jimmy Carter Blvd	770	246-1710	Cincinnati, 45241-1896 .....	2310 East Sharon Rd	513	772-3111
<b>HAWAII</b>							
Honolulu, 96819.....	111 Sand Island Access Rd - Suite R-17	808	842-9925	Columbus, 43229 .....	1948 Schrock Rd	614	895-3112
<b>ILLINOIS</b>							
Tinley Park, 60477 .....	8201 West 183Rd St - Suite P	708	614-1596	Maumee, 43537.....	3661 Briarfield Blvd	419	867-8561
Bensenville, 60106 .....	800 Thorndale Ave	630	521-1097	<b>OKLAHOMA</b>			
<b>INDIANA</b>							
Indianapolis, 46224-3707..	5999 Crawfordsville Rd	317	243-8308	Oklahoma City, 73139 .....	8507 South Western	405	634-8403
<b>IOWA</b>							
Des Moines, 50310 .....	3408 Merle Hay Rd - Suite A	515	270-1340	Tulsa, 74146 .....	11414 East 51st St - Unit C	918	249-8641
<b>KANSAS</b>							
Overland Park, 66214.....	9201 Quivira Rd	913	495-4330	<b>OREGON</b>			
Wichita, 62713 .....	2333 Southwest St	316	943-1271	Portland, 97230.....	14811 Northeast Airport Way - Suite 600	503	255-6556
<b>KENTUCKY</b>							
Louisville, 40213.....	2001 Fern Valley Rd	502	380-3748	<b>PENNSYLVANIA</b>			
<b>LOUISIANA</b>							
Metairie, 70001.....	1801 Airline Dr - Suite D	504	832-2187	Philadelphia, 19148 .....	2715 South Front St	215	271-5500
Baton Rouge, 70816 .....	10699 Airline Hwy - Suite C	225	296-3191	Pittsburgh, 15201 .....	3234 Penn Ave	412	642-0204
Shreveport, 71108 .....	7702 Jewella Rd	318	688-1553	Whitehall, 18052-4522 .....	2242 MacArthur Rd	610	435-9544
<b>MARYLAND</b>							
Baltimore, 21227 .....	1646 Sulphur Spring Rd	410	536-0722	Philadelphia, 19154 .....	2841 Southampton Rd	215	856-7071
Capitol Heights, 20743.....	7957-63 Central Ave	301	333-0865	York, 17402 .....	2201 Industrial Hwy	717	755-3441
<b>MASSACHUSETTS</b>							
Westwood, 02090.....	377 University Ave	781	329-3407	<b>SOUTH CAROLINA</b>			
<b>MICHIGAN</b>							
Madison Heights, 48071 ....	30475 Stephenson Hwy	248	597-5000	North Charleston, 29405....	4365 Dorchester Rd - Suite 104	843	745-9197
Grandville, 49418.....	2982 28th St, S.W.	616	261-0425	Greenville, 29605 .....	1259 South Pleasantburg Dr - Unit C	864	299-8662
<b>MINNESOTA</b>							
Eden Prairie, 55344.....	9709 Valley View Rd - Suite 9709	952	884-9191	<b>TENNESSEE</b>			
<b>MISSOURI</b>							
St. Louis, 63146.....	11477 Page Service Dr	314	997-9100	Memphis, 38133 .....	2686 Kirby-Whitten Rd - Suite 102	901	384-8100
<b>NEBRASKA</b>							
Omaha, 68127-1705.....	4229 South 84th St	402	592-5666	Nashville, 37210 .....	746 Fesslers Ln	615	242-1633
				Knoxville, 37917-2699 .....	4118 North Broadway	865	688-0921
				<b>TEXAS</b>			
				Carrollton, 75006.....	1300 Interstate 35 N. - Suite 112	972	446-2996
				Houston, 77022-2122 .....	536 East Tidwell Rd	713	692-7111
				San Antonio, 78216 .....	1218 Arion Parkway - Suite 114	210	732-1221
				Fort Worth, 76111-5944 ....	721 North Beach St	817	831-3828
				El Paso, 79915-1007 .....	6822 Gateway E.	915	778-9769
				McAllen, 78501 .....	200 North Mccoll - Suite H	956	661-1122
				Austin, 78758 .....	2219 Braker Ln	512	382-3971
				<b>UTAH</b>			
				Salt Lake City, 84104.....	3060 West California Ave - Suite I	801	486-5828
				<b>VIRGINIA</b>			
				Richmond, 23230 .....	2256 Dabney Rd - Suite F	804	353-1197
				Virginia Beach, 23455 .....	5760 Northampton Blvd - Suite 110	757	363-0091
				<b>WASHINGTON</b>			
				Seattle, 98134 .....	2100 Airport Way S.	206	763-2010
				Spokane, 99212 .....	5308 East Sprague Ave	509	535-9252
				<b>WEST VIRGINIA</b>			
				Charleston, 25312-2495 ...	1638 Sixth Ave	304	343-0289
				<b>WISCONSIN</b>			
				West Milwaukee, 53214.....	1650 Miller Pkwy	414	645-4285

# PORTER CABLE®

Quality Tools Since 1906®

Visit [PORTERCABLE.COM](http://PORTERCABLE.COM) for service and support for all PORTER-CABLE® products, instant access to parts lists, interactive exploded views and manuals, current parts pricing and availability and fast parts ordering and shipment tracking.

For the most current and up-to-date listings of all our authorized warranty repair centers and service centers, please call 1-800-223-7278 or visit [PORTERCABLE.COM](http://PORTERCABLE.COM)

<b>3</b>	3 YEAR LIMITED WARRANTY
<b>1</b>	1 YEAR FREE SERVICE
<b>90</b>	90 DAY MONEY BACK GUARANTEE

2 year warranty on batteries

PORTER-CABLE will repair or replace, without charge, any defects due to faulty materials or workmanship in tools for three years from date of purchase (two years for batteries). If you have any problems with this product or questions under this warranty, contact us at 1-888-848-5175.