



FESTOOL

Catalogue **2018**

Tools for the toughest demands



Dear Festool customers,

With every innovation in the Festool system, we are pursuing just one objective: Making the way to achieve perfect working results as easy as possible for you. With products which impress you with extreme robustness and ease of use. And which win you over with sophisticated functions and a high level of operating convenience at the same time.

Our 2018 catalogue includes some real highlights in the range. Leading the way are the first cordless compact sanders to have earned the Festool name – with a high material removal capacity and maximum ease of movement. Our new PLANEX easy long-reach sander, with its low weight and extreme durability, is also a useful aid for making your work easier, as is the smooth suction hose, which slides effortlessly over corners and edges.

You can find these new products, among others, for simple and efficient work on the following pages. Our SERVICE all-inclusive, which, just like our tools, makes work simpler for you, is always included. I hope that you have a lot of fun reading our new catalogue and that the Festool system leads you to achieve success in your work.

Yours Sincerely,

A handwritten signature in black ink, appearing to read 'Bar Austel'. The signature is fluid and cursive.

Barbara Austel
Company partner and granddaughter of founder Gottlieb Stoll



18-volt system	6
Machines, batteries, chargers	
Sawing and oscillating	26
Jigsaws, plunge-cut and portable circular saws, compound mitre saws, semi-stationary saws, oscillators	
Machining surfaces	86
Electric and cordless sanders, compressed air sanders, polishers, brush machines, abrasives	
Dust extraction	178
Mobile dust extractor, AUTOCLEAN mobile dust extractor, special and safety extractor	
Drilling and screwdriving	216
Cordless drills, cordless hammer drills, cordless rotary hammer drills, corded drills, cordless plasterboard screwgun	
Routing	244
Routers, bench-mounted routers, laminate trimmers, aluminium composite milling machines	
Planing	308
Electronic planer, beam planer	
Joining – DOMINO joining system	320
DOMINO joining machines	
Edging	334
Edge bander, semi-stationary edge bander	
Stirring	346
Stirrers, DUO stirrers	
Preparing the substrate	360
Renovation millers, diamond cutting systems, carpet removers	
Illuminating	384
Work lights, working lights, inspection light	
Workplace organisation	394
SYSTAINER, packaging, organisation and transport systems, (semi-) stationary devices, radios	
Fan shop	430
Index	432

01

02

03

04

05

06

07

08

09

10

11

12

13

14

Good ideas for even greater efficiency: New Festool products for 2018.

Fantastic innovative details to make dust extraction easier than ever.

Simply sophisticated: Optimised SYS-Dock with cord holder and T-LOC function for conveniently connecting SYSTAINERS to the mobile dust extractor.

Simply smooth: The new suction hose for perfect sliding over edges, improved handling and a longer service life. With new CLEANTEC extraction sleeve for a secure fit on the tool.

Simply remote-controlled: Can be individually retrofitted with a Bluetooth module for remote operation via a remote control on the suction hose or a Bluetooth battery pack when working with Festool cordless tools.

>> Page 183



Greater ease of movement for better sanding.

The new RTSC 400, DTSC 400 and ETSC 125 cordless compact sanders impress with mobility without a cable. And power similar to that of a mains-powered tool no matter where they are used.

>> Page 88



The perfect solution for machining materials which produce a large quantity of dust.

Granat Net with dust extraction across the entire surface thanks to the mesh structure.

>> Page 151



Now even better.

MULTI-JETSTREAM 2 with improved dust extraction and a longer sanding pad service life.

>> Page 151



For perfect surfaces from the outset.

With the SYSLITE STL 450 inspection light, you can detect unevenness immediately. And therefore achieve the best results more quickly.

>> Page 390



Drywalling has never been so easy.

Easy to handle, durable, lightweight and clean – the PLANEX easy long-reach sander and the special mobile dust extractor with AUTOCLEAN are an unbeatable team for achieving the best results.

>> Page 115



Our responsibility does not end with the quality of the tool.

Every day, we consider how we can make your life easier. With perfectly designed tools – and with services which are always geared towards the requirements of your day-to-day work. You want and need to avoid downtime, unnecessary extra working hours and additional costs wherever possible. We know this and want to do our part by providing SERVICE all-inclusive. The success of our customers is very important to us.



Register online up to 30 days after purchase to ensure that you benefit from all our services.
www.festool.co.uk/myfestool

36 months of free of charge repairs*.

If an item is faulty, we repair it free of charge. Including labour, wear parts and even battery packs. Our transport service will collect the machine from your premises if required and return it as well. That's free, too.

36 months of theft protection.

New tool in the event of theft, more straightforward than insurance: If your tool is stolen – including from a construction site or vehicle – you receive a brand new replacement tool for an excess of £100 including VAT.

10-year replacement parts guarantee.

We will keep every spare part for your tool in stock for this time period – at least. If, in exceptional cases, a spare part is not available, we will send you a new replacement tool free of charge.

15 days money back guarantee.

Not entirely satisfied with the tool you purchased? Simply return it to your dealer within 15 days of purchase and they will refund you the purchase price.

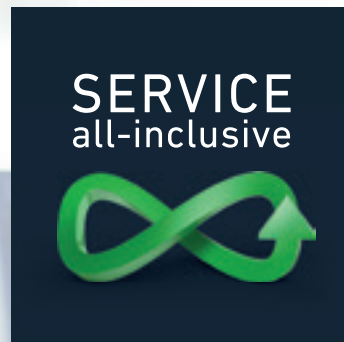

For more information about SERVICE all-inclusive, its validity and our service terms and conditions, please visit www.festool.co.uk/service

SERVICE all-inclusive applies to all machines registered within 30 days after purchase which were purchased on or after 2nd April 2013.

* The cost protection guarantee does not apply for damage to consumables and accessories, improper use, damage caused by the use of non-original accessories or spare parts, if tools are dismantled or if tools are continuously subjected to use resulting in extensive wear.



18-volt system

CARVEX cordless pendulum jigsaws PSC 420, PSBC 420	14
Cordless plunge-cut saw TSC 55	15
Cordless circular saw HKC 55	16
Cordless drill C 18	17
Cordless drill T 18+3	18
Cordless hammer drill BHC 18	19
Cordless drills QUADRIVE DRC 18/4	20
Cordless impact drill QUADRIVE PDC 18/4	21
Cordless drywall screwdrivers DWC 18	22
Working light SYSLITE UNI	23
Working light SYSLITE KAL II	24
Construction site radio SYSROCK BR 10, BR 10 DAB+	25

More power. More endurance. More options. The Festool 18-volt system.

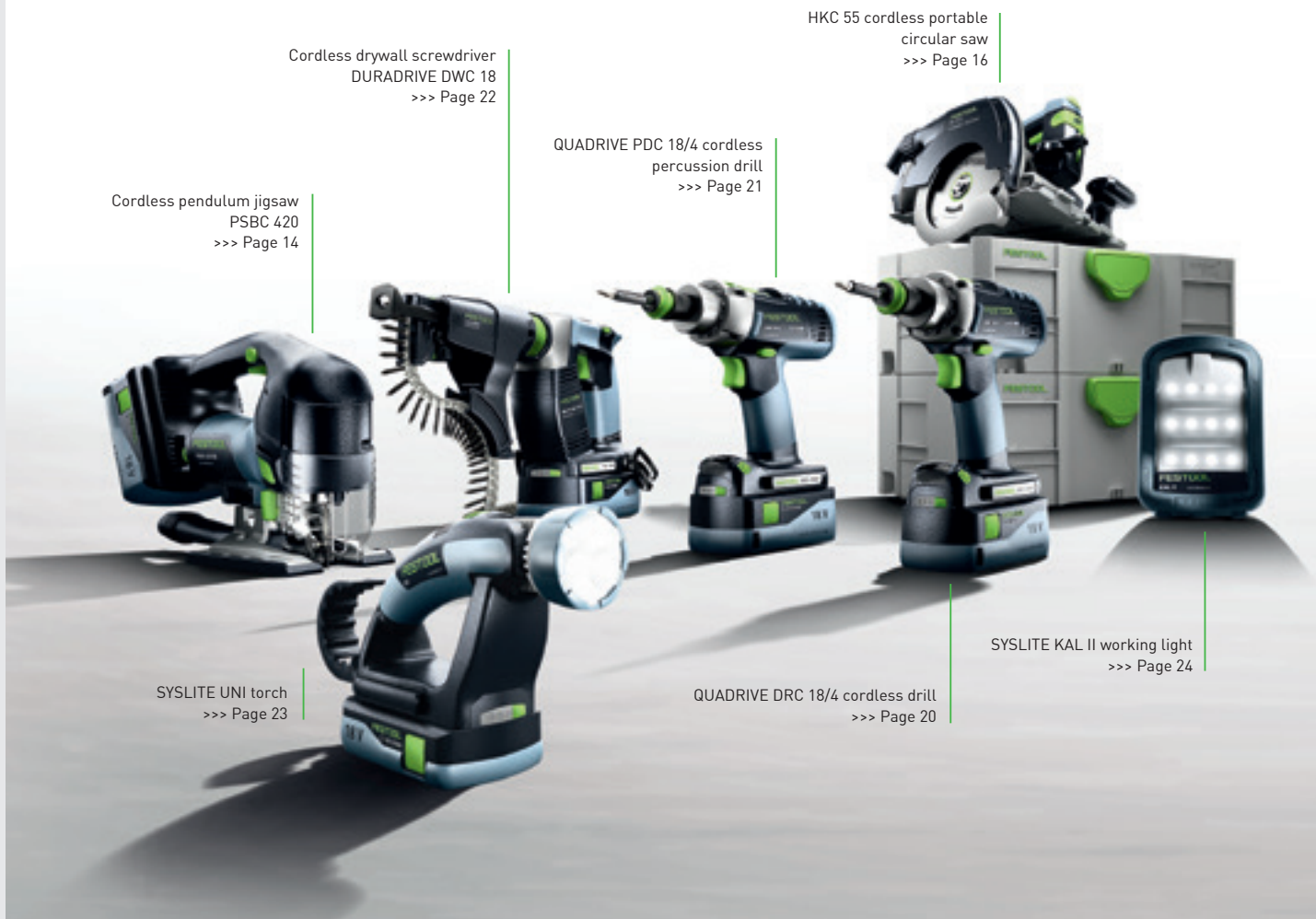

Cordless drywall screwdriver
DURADRIVE DWC 18
>>> Page 22

HKC 55 cordless portable
circular saw
>>> Page 16

Cordless pendulum jigsaw
PSBC 420
>>> Page 14

QUADRIVE PDC 18/4 cordless
percussion drill
>>> Page 21

SYSLITE UNI torch
>>> Page 23

QUADRIVE DRC 18/4 cordless drill
>>> Page 20

SYSLITE KAL II working light
>>> Page 24

Festool's 18-volt system has even more to offer you: Increased continuous power with the new 6.2 Ah battery pack for machine running times which are up to 20% longer. Increased speed thanks to the SCA 8 AIRSTREAM rapid charger with integrated cooling device. Greater endurance due to high-current-resistant battery cells. More options with the three battery pack variants and with PowerSelect for putting together your battery system exactly as you choose. Greater efficiency and comfort when working due to extremely sophisticated tools. And, needless to say, more additional services with our SERVICE all-inclusive.

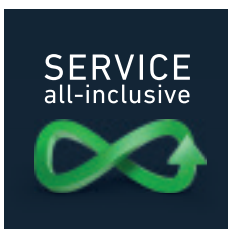

Unique: 36-month warranty for batteries, too.

With Festool you benefit from 36 months of free of charge repairs* – including wear parts. And not just for all our tools but for battery packs and chargers too. Register your machine and enjoy all the advantages of SERVICE all-inclusive: <https://www.festool.co.uk/service>



SERVICE all-inclusive applies to all machines registered within 30 days of purchase and purchased on or after 2nd April 2013. More information and the service terms and conditions can be found at www.festool.co.uk/service

* Free-of-charge repairs do not apply to damage to consumables and accessories, improper use, damage caused by the use of non-original accessories or spare parts, and in the event that tools are dismantled by the user themselves or continuously subjected to use resulting in extensive wear.

Power for any task.

Battery packs and chargers for every application.

Overview of the battery packs.

			
			NEW
AIRSTREAM		<input checked="" type="checkbox"/>	<input checked="" type="checkbox"/>
Bluetooth			<input checked="" type="checkbox"/>
Available with PowerSelect	<input checked="" type="checkbox"/>	<input checked="" type="checkbox"/>	<input checked="" type="checkbox"/>
Available in pre-configured versions	Compact	Plus Plus SCA Set	only as accessory
Suitable chargers	TCL 3 TCL 6 SCA 8	TCL 3 TCL 6 SCA 8 (with AIRSTREAM)	TCL 3 TCL 6 SCA 8 (with AIRSTREAM)
Benefits	<ul style="list-style-type: none"> ▶ Very light, and therefore ideal for drilling and screwdriving ▶ The specialist for ergonomic work ▶ Compact powerhouse 	<ul style="list-style-type: none"> ▶ The all-rounder for all applications ▶ Powerful and durable ▶ Fast charging thanks to AIRSTREAM technology 	<ul style="list-style-type: none"> ▶ The all-rounder for all applications ▶ Enables convenient automatic start-up of dust extractors, including on 18 V machines ▶ Fast charging thanks to AIRSTREAM technology
Weight	0.40 kg	0.70 kg	0.70 kg
Order no.	201789	200181	202479

Increased endurance.

High-current-resistant battery cells guarantee a long service life.

We use only the best quality in Festool tools – right down to the high-current-resistant battery cells. The cells can withstand even heavy loads for years, such as those which occur during sawing applications, as is proven by the quality check performed on the cell technology.

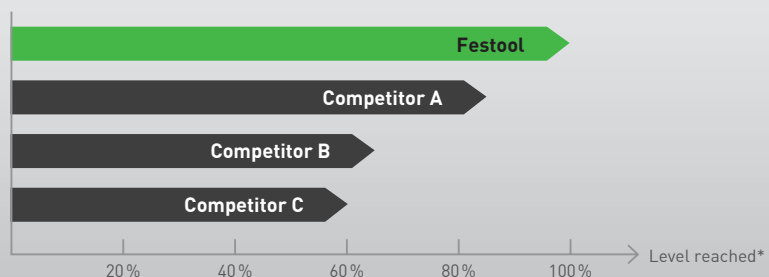

* Test results from the quality check in the Festool laboratory according to discharge tests at maximum load

NEW



6.2 Ah AIRSTREAM Bluetooth



only as accessory

TCL 3
TCL 6
SCA 8 (with AIRSTREAM)

- ▶ For sawing and heavy-duty drilling and screwdriving applications
- ▶ Enables convenient automatic start-up of dust extractors, including on 18 V machines
- ▶ Fast charging thanks to AIRSTREAM technology

0.70 kg

201797

Overview of the chargers.



rapid charger TCL 6



SCA 8 rapid charger

AIRSTREAM

Available with PowerSelect

Available in pre-configured versions

Max. charging current

Benefits

Weight

Order no.



6.0 A

- ▶ LED display for monitoring the charge status

- ▶ for all Festool battery packs (except CXS/TXS)

0.80 kg

201136



8.0 A

- ▶ LED display for showing the remaining charge time and the charge status

- ▶ Optimum use in machines with high power consumption and short downtimes

1.10 kg

200311

Fast and effective –

AIRSTREAM battery packs and SCA 8 AIRSTREAM rapid charger.

SCA 8 rapid charger

with AIRSTREAM (8 amps)

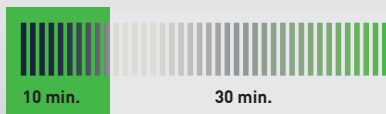

Conventional charger

(3 amperes)



Cooling

Charging

Specifications apply to the 5.2 Ah AIRSTREAM battery

Perfectly compatible.

The most popular combination variants for tools, battery packs and chargers.

COMPACT

Low-cost entry product. Low weight.

Compact battery with a low weight. Perfect for traditional drilling and screwdriving, overhead work and any tasks which require easy handling. And at an attractive price, too.

3.1 Ah compact battery pack

Rapid charger TCL 6

C 18 cordless drill >>> Page 17
T18+3 cordless drills >>> Page 18
Cordless hammer drill BHC 18 >>> Page 19
Cordless drywall screwdriver DURADRIVE DWC 18 >>> Page 22

PLUS

Extremely durable. Versatile.

Powerful 5.2 Ah battery for maximum endurance and power delivery. Ideal for drilling and sawing applications that require high power.

5.2 Ah AIRSTREAM battery pack

Rapid charger TCL 6

C 18 cordless drill >>> Page 17
T18+3 cordless drills >>> Page 18
Cordless hammer drill BHC 18 >>> Page 19
Cordless drywall screwdriver DURADRIVE DWC 18 >>> Page 22
QUADRIVE DRC 18/4 cordless drill >>> Page 20
QUADRIVE PDC 18/4 cordless percussion drill >>> Page 21
CARVEX PSC 420 cordless pendulum jigsaw >>> Page 14
CARVEX PSBC 420 cordless pendulum jigsaw >>> Page 14
Cordless plunge-cut saw TSC 55 >>> Page 15
HKC 55 cordless portable circular saw >>> Page 16

PLUS-SCA

Extremely durable. Ready in an instant.

The perfect combination of the AIRSTREAM battery pack and charger enables extremely rapid charging and working without interruptions.

5.2 Ah AIRSTREAM battery pack

SCA 8 AIRSTREAM rapid charger

QUADRIVE DRC 18/4 cordless drill >>> Page 20
QUADRIVE PDC 18/4 cordless percussion drill >>> Page 21
CARVEX PSC 420 cordless pendulum jigsaw >>> Page 14
CARVEX PSBC 420 cordless pendulum jigsaw >>> Page 14
Cordless plunge-cut saw TSC 55 >>> Page 15
HKC 55 cordless portable circular saw >>> Page 16

SET

Extremely durable. System accessories included.

A vast range of applications thanks to sophisticated system accessories. The all-inclusive trouble-free package incl. AIRSTREAM technology.

5.2 Ah AIRSTREAM battery pack

SCA 8 AIRSTREAM rapid charger

Product-specific system accessories

C 18 cordless drill >>> Page 17
T18+3 cordless drills >>> Page 18
QUADRIVE DRC 18/4 cordless drill >>> Page 20
QUADRIVE PDC 18/4 cordless percussion drill >>> Page 21
CARVEX PSC 420 cordless pendulum jigsaw >>> Page 14
CARVEX PSBC 420 cordless pendulum jigsaw >>> Page 14
Cordless plunge-cut saw TSC 55 >>> Page 15
HKC 55 cordless portable circular saw >>> Page 16

POWERSELECT

Simply select. Simply combine. Simply brilliant.

PowerSelect always provides you with exactly what you need for your battery system at any given time: For example, individual tools, battery packs and chargers. You benefit from fairly calculated prices no matter what you choose. And of course, you can also take advantage of SERVICE all-inclusive for battery packs and chargers.



Basic device

+ Battery pack of your choice



+ Charger of your choice



18-volt system

CARVEX PSC 420 and PSBC 420 cordless pendulum jigsaws



Brushless EC-TEC motor for a long service life and a high level of efficiency



CARVEX PSC / PSBC 420



The cordless version of CARVEX – hard working and powerful.

- ▶ Excellent behaviour in curves thanks to threefold saw blade guide and rigid lifter rod
- ▶ Simple handling thanks to the softgrip and ergonomic design
- ▶ Electronic switch-on/off on both sides, reachable in every grip position
- ▶ Fast, tool-free changing of tables, baseplates and saw blades

Technical data	PSC 420	PSBC 420
Battery voltage (V)	18	18
Stroke rate (min ⁻¹)	1.500 – 3.800	1.000 – 3.800
Pendulum cover adjustment in stages	4	4
Cutting depth in wood (mm)	120	120
Cutting depth in NF metals (mm)	20	20
Cutting depth in steel (soft) (mm)	10	10
Li-ion battery capacity (Ah)	5,2	5,2
Weight (kg)	2,4	2,4



■ = MMC digital electronics

Easy to manage and mobile.

The CARVEX PSC 420 and PSBC 420 follow every move. With millimetre precision. The pendulum jigsaws in the hand are extremely light and intuitive to operate. 3,800 strokes per minute ensure overwhelming force on straight lines when working.

Items included	Order no.
2 x saw blade, splinterguard, in SYSTAINER SYS 2 T-LOC	
PSC 420 Li EB-Basic without battery pack, without charger	574713
PSBC 420 Li EB-Basic without battery pack, without charger	201379
PSC 420 Li 5,2 EB-Plus GB BP 18 Li 5.2 AS battery pack, rapid charger TCL 6	574710
PSC 420 Li 5,2 EB-Plus-SCA GB BP 18 Li 5.2 AS battery pack, SCA 8 rapid charger	574715
PSBC 420 Li 5,2 EB-Plus GB BP 18 Li 5.2 AS battery pack, rapid charger TCL 6	201381
PSBC 420 Li 5,2 EB-Plus-SCA GB BP 18 Li 5.2 AS battery pack, SCA 8 rapid charger	201384

Find the entire Festool sawing range from page 26

System accessories
from page 62

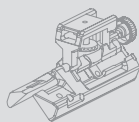

Jigsaw blades
from page 76



Battery and charging technology
from page 10 onwards

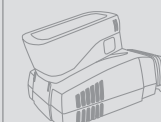



Brushless EC-TEC motor for a long service life and a high level of efficiency



TSC 55



Our best plunge-cut saw is now independent.

- ▶ Brushless EC-TEC motor combined with lithium-ion batteries for maximum cutting power
- ▶ Flexible dual battery concept: Can be operated with two 18-volt battery packs (36V) for maximum power or one 18-volt battery pack for low weight
- ▶ High-speed EC-TEC motor for perfect cutting quality and rapid working progress
- ▶ Dust collection bag for clean, healthy working

Technical data

Battery voltage (V)	18/36
Idle engine speed (min ⁻¹)	2.650 – 3.800/5.200
Saw blade diameter (mm)	160
Angular range (°)	-1 – 47
Cutting depth (mm)	0 – 55
Cutting depth 45° (mm)	43
Dust extraction connection dia. (mm)	27/36
Li-ion battery capacity (Ah)	5,2
Weight 1 x 18 V/2 x 18 V (kg)	4,6/5,3



■ = MMC Multi Material Control electronics

Items included

fine tooth saw blade HW W48, splinterguard, Flag window; vision panel, chip collection bag, operation tool, in SYSTAINER SYS 5 T-LOC

Items included	Order no.
TSC 55 Li REB-Basic without battery pack, without charger	201395
TSC 55 Li 5,2 REB-Plus GB 2 x BP 18 Li 5.2 AS battery pack, rapid charger TCL 6	201390
TSC 55 Li 5,2 REB-Plus-SCA GB 2 x BP 18 Li 5.2 AS battery pack, SCA 8 rapid charger	201397
TSC 55 Li 5,2 REB-Set-FS GB 2 x BP 18 Li 5.2 AS battery pack, SCA 8 rapid charger, guide rail FS 1400/2	201401

Precise and mobile.

Work with precision instead of performing time-consuming rework – with the TSC 55 cordless plunge-cut saw. With a powerful 5200 revolutions per minute. The dual battery system with flexible configuration options ensures absolute mobility in use, allowing you to forget about cables and sockets when working.

Find the entire Festool sawing range from page 26

System accessories from page 64

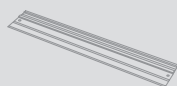

Circular saw blades from page 80



Battery and charging technology from page 10 onwards

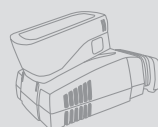

18-volt system

HKC 55 cordless portable circular saw



Brushless EC-TEC motor for a long service life and a high level of efficiency



HKC 55



Precise and portable.

Regardless of how high in the sky you are aiming and how varied your requirements may be – the HKC 55 cordless portable circular saw with FSK cross cutting guide rail can create clean, precise and accurately repeatable cuts practically anywhere.

Standalone in every situation

- ▶ 18V Li-ion battery and connectable cross cutting guide rails ensure mobility and independence
- ▶ Brushless EC-TEC motor combined with lithium-ion batteries for max cutting power
- ▶ In conjunction with the trimming rail, fast, accurate and mobile cross cuts
- ▶ Safe and easy handling thanks to the cutting depth adjustment with plunge function, pendulum hood remote control and guide wedge

Technical data

Battery voltage [V]	18
Idle engine speed [min ⁻¹]	4.500
Saw blade diameter [mm]	160
Angular range [°]	0 – 50
Cutting depth 0°, 90° [mm]	0 – 55
Cutting depth 45°/50° [mm]	42/38
Dust extraction connection dia. [mm]	27/36
Li-ion battery capacity [Ah]	5,2
Weight with Li-ion [kg]	4,1



■ = Electronic

Items included

HW standard saw blade W18, operation tool, in SYSTEMER SYS 4 T-LOC

HKC 55 Li EB-Basic

without battery pack, without charger

Order no.

201358

HKC 55 Li 5,2 EB-Plus GB

2 x BP 18 Li 5.2 AS battery pack, rapid charger TCL 6

201361

HKC 55 Li 5,2 EB-Plus-SCA GB

2 x BP 18 Li 5.2 AS battery pack, SCA 8 rapid charger

201370

HKC 55 Li 5,2 EB-Set-FSK420 GB

SCA 8 rapid charger, 2 x BP 18 Li 5.2 AS battery pack, FSK 420 trimming rail

201373

Find the entire Festool sawing range from page 26

System accessories
from page 65



Circular saw blades
from page 80



Battery and charging technology
from page 10 onwards

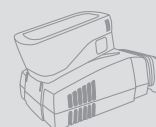



Brushless EC-TEC motor for a long service life and a high level of efficiency



product design award
2010

C 18



The perfect shape.

- ▶ Brushless EC-TEC motor with integrated motor management for long service life and the highest output
- ▶ Fully electronic torque setting and switch-off for precise screwdriving
- ▶ FastFix interface for all FastFix attachments and CENTROTEC rapid tool-change system
- ▶ Switchover from screwdriving to drilling without changing the set torque

Technical data	C 18 Plus/Set	C 18 Compact
Battery voltage (V)	18	18
Gears	2	2
Idling speed, 1st gear/2nd gear (min ⁻¹)	0 - 450/0 - 1.500	0 - 450/0 - 1.500
Drilling diameter, wood/steel (mm)	40/13	40/13
Torque adjustment 1st/2nd gear (Nm)	0,8 - 8/0,5 - 6	0,8 - 8/0,5 - 6
Max. torque, wood/steel (Nm)	27/45	27/45
Chuck range (mm)	1,5 - 13	1,5 - 13
Li-ion battery capacity (Ah)	5,2	3,1
Weight with Li-ion (kg)	1,8	1,5



■ = Electronic

Items included	Order no.
CENTROTEC tool chuck, CENTROTEC bit holder, FastFix keyless chuck 13 mm, bit PZ 2, belt clip, in SYSTAINER SYS 2 T-LOC	
C 18 Li-Basic without battery pack, without charger	574737
C 18 Li 3,1-Compact GB 2 x BP 18 Li 3.1 C battery pack, rapid charger TCL 6	574922
C 18 Li 5,2-Plus GB 2 x BP 18 Li 5.2 AS battery pack, rapid charger TCL 6	574740

Versatile and portable.

Versatility in drilling and screwing. With a high speed and high torque – the new C 18 is the tool for the job, whatever your needs. The CENTROTEC rapid tool change system combines chuck with bit holder, allowing you to change rapidly between drilling, counterboring and screwing.

Find the entire Festool drilling and screw-driving range from page 216

System accessories from page 233

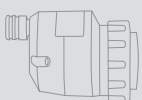

Bits and drills from page 238



Battery and charging technology from page 10 onwards

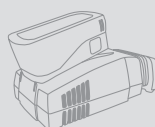

18-volt system

Cordless drill T 18+3



product
design
award

2009

Brushless EC-TEC motor for a long service life and a high level of efficiency



T 18+3



Flexible and mobile.

The T 18+3 is involved in every job without any work interruptions. With the lightweight and compact CENTROTEC quick-change system, you can quickly and easily replace the chuck and bit holder.

Brains meet brawn.

- ▶ FastFix interface for all FastFix attachments and CENTROTEC rapid tool-change system
- ▶ Impressive ergonomics: compact, lightweight and perfectly balanced
- ▶ Fully electronic torque setting and switch-off for precise screwdriving
- ▶ Switchover from screwdriving to drilling without changing the set torque

Technical data	T 18+3 Plus/Set	T 18+3 Compact
Battery voltage (V)	18	18
Gears	2	2
Idling speed, 1st gear/2nd gear (min ⁻¹)	0 - 450/0 - 1.500	0 - 450/0 - 1.500
Drilling diameter, wood/steel (mm)	45/13	45/13
Torque adjustment 1st/2nd gear (Nm)	0,8 - 8/0,5 - 6	0,8 - 8/0,5 - 6
Max. torque, wood/steel (Nm)	35/50	35/50
Chuck range (mm)	1,5 - 13	1,5 - 13
Li-ion battery capacity (Ah)	5,2	3,1
Weight with Li-ion (kg)	1,8	1,5



■ = Electronic

Items included	Order no.
CENTROTEC tool chuck, CENTROTEC bit holder, FastFix keyless chuck 13 mm, bit PZ 2, belt clip, in SYSTAINER SYS 2 T-LOC	
T 18+3 Li-Basic without battery pack, without charger	574763
T 18+3 Li 3,1-Compact GB 2 x BP 18 Li 3.1 C battery pack, rapid charger TCL 6	574909
T 18+3 Li 5,2-Plus GB 2 x BP 18 Li 5.2 AS battery pack, rapid charger TCL 6	574757

Find the entire Festool drilling and screw-driving range from page 216

System accessories
from page 233

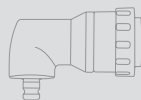

Bits and drills
from page 238



Battery and charging technology
from page 10 onwards

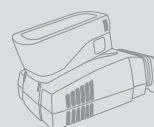

18-volt system

Cordless hammer drill BHC 18



Brushless EC-TEC motor for a long service life and a high level of efficiency



BHC 18



The most powerful compact hammer drill

- ▶ Unbeatable power to weight ratio thanks to the combination of EC-TEC motor and C shape model
- ▶ Vibration damping for effortless work; Maximum working comfort in all work situations
- ▶ Brushless EC-TEC motor with integrated motor management for long service life and the highest output
- ▶ High-quality lithium-ion battery technology for the longest sustained usage

Technical data	BHC 18 Plus	BHC 18 Compact
Battery voltage (V)	18	18
Gears	1	1
Idle engine speed (min ⁻¹)	0 – 1.100	0 – 1.100
Max. number of strokes (min ⁻¹)	4.895	4.895
Drilling dia. (concrete) (mm)	18	18
Max. crown borer hole diameter (mm)	68	68
Max. torque, wood/steel (Nm)	10/25	10/25
Tool holder	SDS-Plus	SDS-Plus
Single impact energy (J)	1,8	1,8
Li-ion battery capacity (Ah)	5,2	3,1
Weight with Li-ion (kg)	2,6	2,3



■ = Electronic

Items included	Order no.
additional side-mounted hand grip, depth stop, in SYSTAINER SYS 2 T-LOC	
BHC 18 Li-Basic without battery pack, without charger	574723
BHC 18 Li 3,1-Compact GB 2 x BP 18 Li 3.1 C battery pack, rapid charger TCL 6	574925
BHC 18 Li 5,2-Plus GB 2 x BP 18 Li 5.2 AS battery pack, rapid charger TCL 6	574721

Lightweight and mobile.

With the BHC 18 you save energy and can work effortlessly. With extremely high impact energy and integrated vibration damping, which absorbs the impact energy before it is transferred to the hands, the BHC 18 sits easily and smoothly in the hand.

Find the entire Festool drilling and screw-driving range from page 216

System accessories
from page 234



Battery and charging technology
from page 10 onwards



18-volt system

QUADRIVE DRC 18/4 cordless drill

Brushless EC-TEC motor for a long service life and a high level of efficiency



QUADRIVE DRC 18/4



The compact tool with impressive rotary power.

- ▶ Brushless EC-TEC motor for maximum service life and efficiency
- ▶ 4-speed gearbox capable of 3800 rpm for rapid, clean drilling results
- ▶ Universal solution for fastening operations that require high torque and for drilling large diameter holes
- ▶ Individually selectable LED lighting and battery status display

Technical data

Battery voltage (V)	18
Gears	4
Idling speed, 1st gear/2nd gear (min ⁻¹)	0 – 400/0 – 850
Idling speed, 3rd/4th gear (min ⁻¹)	0 – 1.850/0 – 3.800
Max. torque, wood/steel (Nm)	40/60
Drilling diameter (wood/steel) (mm)	50/13
Chuck range (mm)	1,5 – 13
Li-ion battery capacity (Ah)	5,2
Weight with Li-ion (kg)	1,9



□ = Electronic

Sturdy and mobile.

60 Nm torque in first gear for powerful screwing, 3800 rpm in fourth gear for precise drilling. Untiring and enormously toughwhether on wood or metal – everyone who knows the QUADRIVE series is impressed by the combination of high power and absolute precision. The FastFix interface enables quick change to a CENTROTEC tool chuck, keyless chuck, crosshead or socket spanner adapter without the need for tools.

Items included

Order no.

CENTROTEC tool chuck, CENTROTEC bit holder, FastFix keyless chuck 13 mm, bit PZ 2, additional side-mounted hand grip, in SYSTAINER SYS 2 DF T-LOC

DRC 18/4 Li-Basic

without battery pack, without charger

574695

DRC 18/4 Li 5,2-Plus GB

2 x BP 18 Li 5.2 AS battery pack, rapid charger TCL 6

574698

DRC 18/4 Li 5,2-Plus-SCA GB

2 x BP 18 Li 5.2 AS battery pack, SCA 8 rapid charger

574917

Find the entire Festool drilling and screw-driving range from page 216

System accessories
from page 235



Bits and drills
from page 238



Battery and charging technology
from page 10 onwards





Brushless EC-TEC motor for a long service life and a high level of efficiency

QUADRIVE PDC 18/4

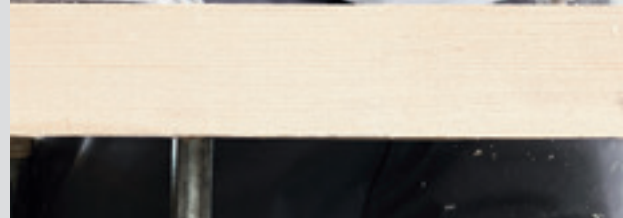

The multi-talented tool that makes a percussion.

- ▶ Brushless EC-TEC motor for maximum service life and efficiency
- ▶ EC-TEC motor combined with high-quality lithium-ion battery technology for up to 100% greater fastening capacity
- ▶ 4-speed gearbox capable of 3800 rpm for rapid, clean drilling results
- ▶ Individually selectable LED lighting and battery status display

Technical data

Battery voltage (V)	18
Gears	4
Idling speed, 1st gear/2nd gear (min ⁻¹)	0 – 400/0 – 850
Idling speed, 3rd/4th gear (min ⁻¹)	0 – 1.850/0 – 3.800
Max. number of strokes (min ⁻¹)	76.000
Max. torque, wood/steel (Nm)	40/60
Drilling diameter (wood/steel) (mm)	50/13
Drilling diameter in brickwork (mm)	10
Chuck range (mm)	1,5 – 13
Li-ion battery capacity (Ah)	5,2
Weight with Li-ion (kg)	2



■ = Electronic

Items included

CENTROTEC chuck, CENTROTEC bit holder, FastFix keyless chuck 13 mm, bit PZ 2, additional side-mounted hand grip, in SYSTAINER SYS 2 DF T-LOC

PDC 18/4 Li-Basic 574701
without battery pack, without charger

PDC 18/4 Li 5,2-Plus GB 574705
2 x BP 18 Li 5.2 AS battery pack, rapid charger TCL 6

PDC 18/4 Li 5,2-Plus-SCA GB 574919
2 x BP 18 Li 5.2 AS battery pack, SCA 8 rapid charger

Find the entire Festool drilling and screw-driving range from page 216

System accessories from page 235



Bits and drills from page 238



Battery and charging technology from page 10 onwards

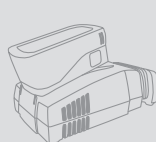

Powerful and mobile.

Much like the QUADRIVE DRC 18/4, the QUADRIVE PDC 18/4 offers a full range of features and sophisticated functionalities, and also provides an axial impact function that can be activated for drilling in masonry.

18-volt system

Cordless drywall screwdriver
DURADRIVE DWC 18

Brushless EC-TEC motor for a long service life and a high level of efficiency



DURADRIVE DWC 18

Power and durability for interior work.

- ▶ Precision, wear-free electronic switch-off function for accurate insertion depths and a long service life
- ▶ Energy-saving function for machine start/stop without actuating the main switch
- ▶ Robust, brushless EC motor for maximum efficiency and durability
- ▶ Rapid change to magazine attachment without using tools

Technical data	DW 18-2500	DW 18-2500	DW 18-4500	DW 18-4500
	Plus	Compact	Plus	Compact
Battery voltage [V]	18	18	18	18
Gears	1	1	1	1
Idle engine speed [min ⁻¹]	0 – 2.500	0 – 2.500	0 – 4.500	0 – 4.500
Max. torque, wood/steel [Nm]	7/18	7/18	5/14	5/14
Max. machinable screw length [mm]	55	55	55	55
Tool holder	1/4"	1/4"	1/4"	1/4"
Li-ion battery capacity [Ah]	5,2	3,1	5,2	3,1
Weight with depth stop [kg]	1,9	1,6	1,9	1,6
Weight with magazine attachment [kg]	2,3	2	2,3	2



■ = Electronic

Items included	Order no.
magazine attachment, depth stop, scaffolding holder, magnetic bit holder, 2 x bit PH2, long, PH 2 bit, belt clip, in SYSTAINER SYS 2 T-LOC	
DWC 18-2500 Li-Basic without battery pack, without charger	574742
DWC 18-4500 Li-Basic without battery pack, without charger	574747
DWC 18-2500 Li 5,2-Plus GB 2 x BP 18 Li 5.2 AS battery pack, rapid charger TCL 6	574744
DWC 18-4500 Li 5,2-Plus GB 2 x BP 18 Li 5.2 AS battery pack, rapid charger TCL 6	574746

Innovative and mobile.

The DURADRIVE DWC 18 allows you to make series screw connections comfortably and as efficiently as possible. The innovative stop-and-go function ensures up to 40% higher performance per battery charge.

Find the entire Festool drilling and screw-driving range from page 216

System accessories
from page 237



Drywall screws
from page 243



Battery and charging technology
from page 10 onwards

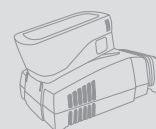



SYSLITE UNI



The light to the tool.

- ▶ Three powerful, energy-efficient, high-performance LEDs
- ▶ Lamp head can be adjusted into nine different positions by a vertical angle of 135°
- ▶ Stable and tilt-resistant, or can be flexibly attached using belt clip and trestle hook

Technical data

Battery voltage (V)	10,8/18
Light source	3 SMD LEDs
Lumen value (lm)	43
Weight (without battery pack) (kg)	0,34

Compact and mobile.

The handy SYSLITE UNI is always ready to light up dark corners. Its lightweight and compact design makes it a welcome working aid. It is compatible with all conventional Festool batteries.

not available in Great Britain

Festool's full range of lights can be found from page 384 onwards

Battery and charging technology
from page 10 onwards

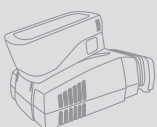

18-volt system

SYSLITE KAL II working light



product
design award

2012



SYSLITE KAL II



Luminous and mobile.

Five available installation and mounting positions: The SYSLITE KAL II lights up the darkest of corners for up to six hours non-stop. The housing is made from shatter-proof, shock-proof and impact-resistant cast aluminium – durable enough for any construction site. The large light dispersion angle of 170° ensures that the entire work surface is illuminated uniformly.

The light to the tool.

- ▶ Excellent light thanks to 12 high-performance LEDs
- ▶ Long life and robust thanks to shatter-proof housing
- ▶ Continuous use – any Festool battery pack can be attached to supplement the internal battery. The 230 V mains power pack and vehicle charging cable offer additional charging and power supply options
- ▶ Compact design – can be flexibly positioned without cable hazards

Technical data

Light source (W)	12 x 1,5
Lumen value 1st/2nd stage (lm)	310/769
Operating time (internal battery) 1st/2nd stage (min)	290/110
Li-ion battery capacity (Ah)	2,9
Li-ion charging time (min)	200
Permissible operating temperature range (°C)	-5/+ 55
Operation with external Festool battery packs (V)	10,8 – 18
Hook opening (mm)	40
Thread size stand (*)	1/4
Dimensions (L x W x H) (mm)	80 x 100 x 150
Weight (without battery pack) (kg)	0,7

Items included

integrated lithium-ion battery 7.2 V, car charger adapter, 230 V adapter, transport bag, in self-service display pack

KAL II GB 240V

Order no.

500722

KAL II-Set GB 240V

magnetic spherical head with flat disc

499816

Festool's full range of lights can be found from page 384 onwards

System accessories from page 391



Battery and charging technology from page 10 onwards

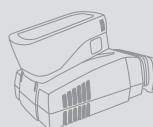



SYSROCK



Perfectly formed for perfect sound. Also available as a DAB+ version.

- ▶ Various receiving and playback options via Bluetooth and AUX-IN interfaces – available as analogue or digital radio
- ▶ Integrated USB interface for charging external devices such as mobile devices (with BR 10 DAB+)
- ▶ Excellent sound in a compact, modern and robust design
- ▶ Intuitive operation via large buttons and colour LCD display

Technical data	BR 10 DAB+	BR 10
Radio reception	DAB+ digital radio	FM analogue radio
FM frequency band [VHF] (MHz)	87,5 – 108	87,5 – 108
Speaker (W)	10	10
Operation with Festool slide-in battery packs (V)	18	18
Number of stored stations	2 x 4	4
AUX-IN (mm)	3,5	3,5
Bluetooth standard	4,1	4,1
USB output	5V/1,2A	–
Dimensions (L x W x H) (mm)	95 x 102 x 149	94 x 102 x 149
Weight (kg)	0,7	0,7



Items included

230 V adapter, aux-in cable, in bag

BR10 DAB+ GB 240V

DAB+ digital radio

202112

BR 10 GB 240V

FM analogue radio

200185

Powerful and mobile.

The SYSROCK construction site radios fit on every windowsill and combine compact dimensions with a low weight and impeccable sound. And thanks to the Bluetooth interface, you can listen to your favourite radio stations and tracks from your smartphone with SYSROCK sound quality.

Battery and charging technology
from page 10 onwards

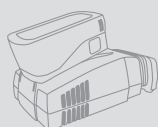



Sawing and oscillating

Overview of products and applications	28
---------------------------------------	----

Jig saws

TRION pendulum jigsaws PS 300, PSB 300	35
CARVEX pendulum jigsaws PS 420, PSB 420	36
CARVEX cordless pendulum jigsaws PSC 420, PSBC 420	37
Bench saw CMS PS 300	39

Circular saws

Circular saws TS 55 R, TS 75	40
Cordless plunge-cut saw TSC 55	41
Bench saw CMS-TS	43

Circular saws

Circular saws HK 55, HK 85	44
Cordless circular saw HKC 55	45
Cross cutting guide rail FSK	47
Carpentry portable circular saw HK 132	48

Compound mitre saws

KAPEX sliding compound mitre saws KS 60, KS 88, KS 120	49
Compound mitre saw SYMMETRIC SYM 70	52

Semi-stationary sawing

Trimming saw PRECISIO CS 50, CS 70	53
------------------------------------	----

Sword saws

Sword saws SSU 200, IS 330	55
----------------------------	----

Oscillator

VECTURO oscillator OS 400	57
---------------------------	----

Accessories and consumable materials

The Festool system	60
--------------------	----

Sawing and oscillating

Overview of products and applications

Page 35 ————— 35 ————— 36 ————— 36

Powerful. Precise. Robust. The impressive Festool pendulum jigsaws guarantee easy handling and rapid cutting progress. Available in body grip or D handle – optimised in every respect to achieve excellent results

PS 300

PSB 300

PS 420

PSB 420



Applications

TRION pendulum jigsaws

CARVEX pendulum jigsaws

Sawing with jigsaws

Work independent of the mains power supply

Cut-outs for sinks and kitchen hobs

Trimming work on furniture, kitchens, for interior fitting

Cutting circles and curves



Coping end strips

Cutting workpieces to length

Edge notching on beams

Cutting from below



Semi-stationary sawing

Cutting accurately along the scribe line

Precise coping during trimming work

Preliminary cutting work prior to routing shapes

Technical data

	PS 300	PSB 300	PS 420	PSB 420
Power consumption (W)	720	720	550	550
Battery voltage (V)				
Li-ion battery capacity (Ah)				
Stroke rate (rpm)	1.000 – 2.900	1.000 – 2.900	1.500 – 3.800	1.000 – 3.800
Pendulum cover adjustment in stages	4	4	4	4
Inclination (°)	0 – 45	0 – 45		
Cutting depth in wood (mm)	120	120	120	120
Cutting depth in NF metals (mm)	20	20	20	20
Cutting depth in steel (soft) (mm)	10	10	10	10
Weight (kg)	2,4	2,4	1,9	1,9

Sawing and oscillating

Overview of products and applications

37 ——— 38 ——— 39

PSC 420

PSBC 420

CMS PS 300



CARVEX pendulum jigsaws

Compact Module System CMS



Extremely appropriate Appropriate

			720
18	18		
5,2	5,2		
1.500 – 3.800	1.000 – 3.800		1.000 – 2.900
4	4		4
			0 – 45
120	120		120
20	20		20
10	10		10
2,4	2,4		2,4/5,7

Sawing and oscillating

Overview of products and applications

Introducing the saws from Festool. Accurate to the millimetre, they cut with the necessary force for each material, yet are lightweight and easy to handle.

Page 40 — 41 — 42 — 43 — 43

TS 55 R

TSC 55

TS 75

CMS TS 55 R

CMS TS 75



Applications

Circular saws

Compact Module System CMS TS

Sawing using plunge-cut saws

- Cutting recesses in kitchen worktops
- Cutting doors to length
- Cutting chipboard to size
- Cutting house doors to size, up to 75 mm thick



Semi-stationary sawing

- Sawing panels and laminate
- Rip cuts in boards and panels
- Cutting plastic and steel cable ducts to size
- Cutting grooves to a defined depth

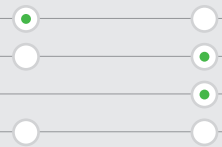

Sawing with portable circular saws

- Cutting roof battens to length
- Sawing boards to size
- Sawing chipboard
- Cutting tenons in beams
- Splitting tenons
- Tapering square timber and rafters
- Tenons and square timber with compound mitre cut

Technical data

	TS 55 R	TSC 55	TS 75	CMS TS 55 R	CMS TS 75
Power consumption (W)	1.200		1.600	1.200	1.600
Idle engine speed (rpm)	2.000 – 5.200	2.650 – 3.800/5.200	1.350 – 3.550	2.000 – 5.200	1.350 – 3.550
Battery voltage (V)		1 x 18/2 x 18 (36)			
Li-ion battery capacity (Ah)		5,2			
Saw blade Ø (mm)	160	160	210	160	210
Cutting depth (mm)	0 – 55	0 – 55	0 – 75		
Cutting depth 45° (mm)	43	43	55		
Cutting height 90°/45° (mm)				0 – 51/0 – 38	0 – 70/0 – 48
Weight (kg)	4,5	4,6/5,3	6,2	3,3/7,8	3,3/9,5

Sawing and oscillating

Overview of products and applications

44 ——— 45 ——— 46 ——— 48

HK 55 HKC 55 HK 85 HK 132



Circular saws

Carpentry portable circular saw

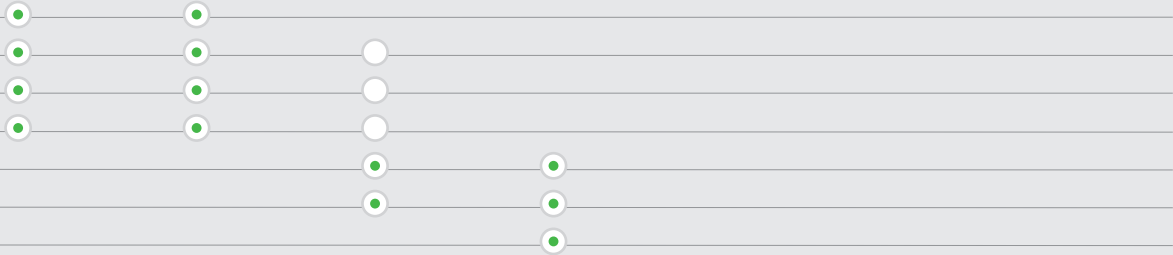

Extremely appropriate Appropriate

	1.200		2.300	2.300
	2.000 – 5.200	4.500	1.500 – 3.300	2.200
		18		
		5,2		
	160	160	230	350
	0 – 55	0 – 55	0 – 85	50 – 132
	42	42	62	85
	4,4	4,1	7,0	18,0

Sawing and oscillating

Overview of products and applications

Introducing the saws from Festool. Accurate to the millimetre, they cut with the necessary force for each material, yet are lightweight and easy to handle.

Page 49 ————— 50 ————— 51 ————— 52

KS 60

KS 88

KS 120

SYM 70



Applications

KAPEX sliding compound mitre saws

Compound mitre saw SYMMETRIC

Semi-stationary sawing

Sawing panels and laminate

Rip cuts in boards and panels

Cutting plastic and steel cable ducts to size

Cutting grooves to a defined depth

Trimming aluminium and other non-ferrous metal profiles

Trimming skirting boards and cornices up to 120 mm in height

Trimming skirting board along the bisector

Cutting strip material to fit

Trimming beams and boards up to 60 mm thick

Trimming beams and square timber up to 88 mm thick

Rip cuts with a cutting depth up to 52 mm

Rip cuts with a maximum cutting depth of 70 mm

Sawing obscured cuts, grooves and rebates

Cutting with sword saws

Cutting soft and hard wood

Cutting wood fibre/PUR insulating boards

Cutting polystyrene

Technical data

Power consumption (W)	1.200	1.600	1.600	1.150
Idle engine speed (rpm)	1.300 – 3.500	1.400 – 3.400	1.400 – 3.400	2.700 – 5.200
Saw blade Ø (mm)	216	260	260	216
Cutting depth 90°/90° (mm)	305 x 60	305 x 88	305 x 88	
Cutting depth 45°/90° (mm)	215 x 60	215 x 88	215 x 88	
Cutting depth 0°, 90°/45°/60° (mm)				
Weight (kg)	17,8	20,7	21,5	9,5

Sawing and oscillating

Overview of products and applications

53 ——— 54 ——— 55 ——— 56

CS 50
CS 50 Set

CS 70
CS 70 Set

SSU 200

IS 330



Bench-mounted trimming saws
PRECISIO

Sword saws



* Set variants

● Extremely appropriate

○ Appropriate

	1.200	2.200	1.600	1.600
	1.600 – 4.200	2.000 – 4.200	4.600	4.600
	190	225		
	0 – 52/0 – 37	0 – 70/0 – 48		
			200/140/100	330/230/165
	17,4/41,3	34,5/66,0	6,5	7,0

Sawing and oscillating

Overview of products and applications

Page 57 ——— 57

Powerful, ergonomic, diverse and perfect in the system. With the VECTURO OS 400, you make better cuts everywhere. It offers precise cuts along the scribe mark, perfect cuts for previously defined cutting depths or flush cuts to the wall. But it also offers the decisive precision.

VECTURO OS 400

VECTURO OS 400 Set



Applications

Oscillator

Sawing

Notches and recesses from sheet material	<input type="radio"/>	<input checked="" type="radio"/>
Cutting sheet material to length	<input type="radio"/>	<input type="radio"/>
Cutting strip material and slats to length	<input type="radio"/>	<input checked="" type="radio"/>
Flush cutting non-ferrous iron or plastic pipes	<input checked="" type="radio"/>	<input checked="" type="radio"/>

Trimming and adapting laminate/parquet flooring	<input type="radio"/>	<input checked="" type="radio"/>
Notching or cutting skirting boards or joining strips and floor edging to length	<input checked="" type="radio"/>	<input checked="" type="radio"/>
Cutting door frame to length	<input type="radio"/>	<input checked="" type="radio"/>
Reworking expansion joints	<input type="radio"/>	<input checked="" type="radio"/>

Cutting out insulating washers in the putty bed	<input checked="" type="radio"/>	<input checked="" type="radio"/>
Notching on beams, strip material or boards	<input type="radio"/>	<input checked="" type="radio"/>
Sawing along scribe mark	<input type="radio"/>	<input checked="" type="radio"/>
Sawing to a defined depth	<input type="radio"/>	<input checked="" type="radio"/>

Scraping

Removal of old layers and coatings e.g. protective underlay, adhesive residues	<input type="radio"/>	<input type="radio"/>
--	-----------------------	-----------------------

Extremely appropriate Appropriate

Technical data

Power (W)	400
Power output (W)	220
Vibration (rpm)	11.000 – 18.500
Amplitude (°)	2
Cable length (m)	5
Weight (kg)	1,6



TRION PS / PSB 300

Ideal for flexible use.

- ▶ Patented three-way saw blade guide for cutting precise angles
- ▶ FastFix rapid-change system for easy saw blade changes
- ▶ Compatible in the system – integrated in the CMS system as a semi-stationary saw
- ▶ High-quality drive components give longer service life

Technical data

Power consumption [W]	720
Stroke rate [min ⁻¹]	1.000 – 2.900
Pendulum cover adjustment in stages	4
Inclination [°]	0 – 45
Cutting depth in wood [mm]	120
Cutting depth in NF metals [mm]	20
Cutting depth in steel (soft) [mm]	10
Weight [kg]	2,4



■ = MMC Multi Material Control electronics

Items included	Order no.
2 x saw blade, splinterguard, in SYSTAINER SYS 1 T-LOC	
PS 300 EQ-Plus GB 240V	561450
PS 300 EQ-Plus GB 110V	561449
PSB 300 EQ-Plus GB 240V	561459
PSB 300 EQ-Plus GB 110V	561457



Powerful and consistently accurate.

Rapid cutting progress and superior precision are just two of the impressive characteristics of the TRION PS 300. The patented three-way saw blade guide with parallel adjustable carbide jaws guarantees straight precision cuts.

System accessories from page 62

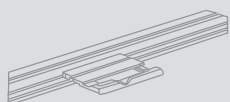

Jigsaw blades from page 76



Sawing and oscillating

CARVEX PS 420 and PSB 420 pendulum jigsaws



product
design
award

2010

Brushless EC-TEC motor for a long service life and a high level of efficiency



CARVEX PS / PSB 420



Lightweight. Handy. Unbeatable profile-cutting capacity.

- ▶ Excellent behaviour in curves thanks to threefold saw blade guide and rigid lifter rod
- ▶ Simple handling thanks to the softgrip and ergonomic design
- ▶ Electronic switch-on/off on both sides, reachable in every grip position
- ▶ Fast, tool-free changing of tables, baseplates and saw blades

Technical data	PS 420	PSB 420
Power consumption (W)	550	550
Stroke rate (min ⁻¹)	1.500 – 3.800	1.000 – 3.800
Pendulum cover adjustment in stages	4	4
Cutting depth in wood (mm)	120	120
Cutting depth in NF metals (mm)	20	20
Cutting depth in steel (soft) (mm)	10	10
Weight (kg)	1,9	1,9



■ = MMC digital electronics

Follows only one line. Yours.

Power that you can feel. Revolutionary technology that makes the tightest curve feel like you are cutting in a straight line. It is the combination of outstanding features that makes the CARVEX PS 420 such an exceptional pendulum jigsaw.

Items included	Order no.
2 x saw blade, splinterguard, in SYSTAINER SYS 1 T-LOC	
PS 420 EBQ-Plus GB 240V	561590
PS 420 EBQ-Plus GB 110V	561589
PS 420 EBQ-Set GB 240V accessories SYSTAINER	561591
PS 420 EBQ-Set GB 110V accessories SYSTAINER	561592
PSB 420 EBQ-Plus GB 240V	561605
PSB 420 EBQ-Plus GB 110V	561604
PSB 420 EBQ-Set GB 240V accessories SYSTAINER	561606
PSB 420 EBQ-Set GB 110V accessories SYSTAINER	561607

System accessories
from page 62

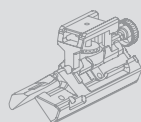

Jigsaw blades
from page 76

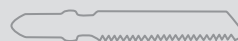

Sawing and oscillating CARVEX PSC 420 cordless pendulum jigsaw



Brushless EC-TEC motor for a long service life and a high level of efficiency



02

CARVEX PSC 420



The cordless version of CARVEX – hard working and powerful.

- ▶ Excellent behaviour in curves thanks to threefold saw blade guide and rigid lifter rod
- ▶ Simple handling thanks to the softgrip and ergonomic design
- ▶ Electronic switch-on/off on both sides, reachable in every grip position
- ▶ Fast, tool-free changing of tables, baseplates and saw blades

Technical data

Battery voltage (V)	18
Stroke rate (min ⁻¹)	1.500 – 3.800
Pendulum cover adjustment in stages	4
Cutting depth in wood (mm)	120
Cutting depth in NF metals (mm)	20
Cutting depth in steel (soft) (mm)	10
Li-ion battery capacity (Ah)	5,2
Weight (kg)	2,4



■ = MMC digital electronics

Items included

Items included	Order no.
2 x saw blade, splinterguard, in SYSTAINER SYS 2 T-LOC	
PSC 420 Li EB-Basic without battery pack, without charger	574713
PSC 420 Li 5,2 EB-Plus GB BP 18 Li 5.2 AS battery pack, rapid charger TCL 6	574710
PSC 420 Li 5,2 EB-Plus-SCA GB BP 18 Li 5.2 AS battery pack, SCA 8 rapid charger	574715
PSC 420 Li 5,2 EB-Set GB BP 18 Li 5.2 AS battery pack, SCA 8 rapid charger, accessories SYSTAINER	574718

Perfect combination of power and flexibility.

What do you get when you cross a powerful cutting stroke with effortless handling around bends and corners? Pure enthusiasm for the CARVEX. Also innovative battery technology that provides greater flexibility. It matches the high cutting performance achieved with cabled versions, is long-lasting and superior to other cordless saws.

System accessories from page 62

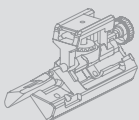

Jigsaw blades from page 76



Battery and charging technology from page 10 onwards



Sawing and oscillating

CARVEX PSBC 420 cordless pendulum jigsaw



Brushless EC-TEC motor for a long service life and a high level of efficiency



CARVEX PSBC 420



Powerful tool with stirrup handle.

As a D-handle variant of the CARVEX PSC 420, the CARVEX PSBC 420 offers the same sophisticated features. This means that all users can select the handle shape that suits them best, according to their own personal preferences.

The cordless D-handle version of the CARVEX – performance similar to a mains-powered tool.

- ▶ Excellent behaviour in curves thanks to threefold saw blade guide and rigid lifter rod
- ▶ Simple handling thanks to the softgrip and ergonomic design
- ▶ Electronic switch-on/off on both sides, reachable in every grip position
- ▶ Fast, tool-free changing of tables, baseplates and saw blades

Technical data

Battery voltage (V)	18
Stroke rate (min ⁻¹)	1.000 – 3.800
Pendulum cover adjustment in stages	4
Cutting depth in wood (mm)	120
Cutting depth in NF metals (mm)	20
Cutting depth in steel (soft) (mm)	10
Li-ion battery capacity (Ah)	5,2
Weight (kg)	2,4



■ = MMC digital electronics

Items included	Order no.
2 x saw blade, splinterguard, in SYSTAINER SYS 2 T-LOC	
PSBC 420 Li EB-Basic without battery pack, without charger	201379
PSBC 420 Li 5,2 EB-Plus GB BP 18 Li 5.2 AS battery pack, rapid charger TCL 6	201381
PSBC 420 Li 5,2 EB-Plus-SCA GB BP 18 Li 5.2 AS battery pack, SCA 8 rapid charger	201384
PSBC 420 Li 5,2 EB-Set GB SCA 8 rapid charger, BP 18 Li 5.2 AS battery pack, accessories SYSTAINER	201387

System accessories from page 62

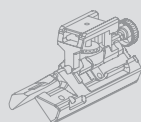

Jigsaw blades from page 76



Battery and charging technology from page 10 onwards



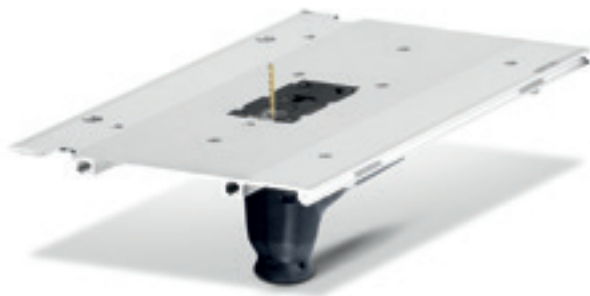

CMS-PS



Jigsaw for the CMS system.

- ▶ Module carrier for installing jigsaws to form a jigsaw module
- ▶ Also available with jigsaw PS 300
- ▶ The jigsaw can be used not only as a bench-mounted tool, but also as a handheld tool
- ▶ Flexible extension options – for an even wider range of applications

Technical data

Power consumption [W]	720
Stroke rate [min ⁻¹]	1.000 – 2.900
Pendulum cover adjustment in stages	4
Cutting depth in wood [mm]	120
Cutting depth in NF metals [mm]	20
Inclination [°]	0 – 45
Cutting depth in steel (soft) [mm]	10
Dust extraction connection dia. [mm]	27
Dimensions module support [mm]	578 x 320
Weight module support [kg]	3,3
Weight [kg]	2,4



■ = MMC Multi Material Control electronics

Items included	Order no.
CMS-PS assembly lugs, operation tool, in carton	561262

From mobile to stationary in a matter of seconds.

This module mounting is used to equip jigsaws for stationary work. For cutting shapes and curves accurately as well as minor notching during trimming work.

CMS system overview
from page 396



Jigsaw blades
from page 76



Sawing and oscillating

TS 55 R Plunge-cut saw

TS 55 R



Even more precise. Flat body.

Many of the standard features of today's portable circular saws originated from the TS 55. The TS 55 is now starting the next chapter in its success story with a wide range of innovations such as an ultra slimline housing for even greater flexibility, a recently developed guide wedge for even greater safety and precision and many other ideas that make the TS 55 R the best plunge-cut saw we have ever built.

The best plunge-cut saw we have ever built.

- ▶ Slimline housing for maximum flexibility and close proximity to the wall (12 mm)
- ▶ Angle adjustment with undercut function from -1 to 47°
- ▶ Guide wedge for safer work and simple positioning in existing joint
- ▶ Transparent sliding viewing window provides a good view of the scribe mark and saw blade

Technical data

Power consumption (W)	1.200
Idle engine speed (min ⁻¹)	2.000 – 5.200
Saw blade diameter (mm)	160
Angular range (°)	-1 – 47
Cutting depth (mm)	0 – 55
Cutting depth 45° (mm)	43
Dust extraction connection dia. (mm)	27/36
Weight (kg)	4,5



■ = MMC Multi Material Control electronics

Items included

splinterguard, Flag window; vision panel, operation tool, in SYSTEMER SYS 4 T-LOC

	Order no.
TS 55 REQ-Plus GB 110V fine tooth saw blade HW W48	561554
TS 55 REQ-Plus-FS GB 110V fine tooth saw blade HW W48, guide rail FS 1400/2	561584
TS 55 REBQ-Plus GB 240V fine tooth saw blade HW W48	561553
TS 55 REBQ-Plus-FS GB 240V fine tooth saw blade HW W48, guide rail FS 1400/2	561583

System accessories from page 64

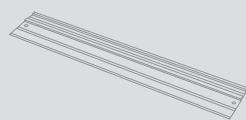

Circular saw blades from page 80



Sawing and oscillating

Cordless plunge-cut saw TSC 55

02



Brushless EC-TEC motor for a long service life and a high level of efficiency



TSC 55



Our best plunge-cut saw is now independent.

- ▶ Brushless EC-TEC motor combined with lithium-ion batteries for maximum cutting power
- ▶ Flexible dual battery concept: Can be operated with two 18-volt battery packs (36V) for maximum power or one 18-volt battery pack for low weight
- ▶ High-speed EC-TEC motor for perfect cutting quality and rapid working progress
- ▶ Dust collection bag for clean, healthy working

Technical data

Battery voltage (V)	18/36
Idle engine speed (min ⁻¹)	2.650 – 3.800/5.200
Saw blade diameter (mm)	160
Angular range (°)	-1 – 47
Cutting depth (mm)	0 – 55
Cutting depth 45° (mm)	43
Dust extraction connection dia. (mm)	27/36
Li-ion battery capacity (Ah)	5,2
Weight 1 x 18 V/2 x 18 V (kg)	4,6/5,3



■ = MMC Multi Material Control electronics

Items included	Order no.
fine tooth saw blade HW W48, splinterguard, Flag window; vision panel, chip collection bag, operation tool, in SYSTAINER SYS 5 T-LOC	
TSC 55 Li REB-Basic without battery pack, without charger	201395
TSC 55 Li 5,2 REB-Plus GB 2 x BP 18 Li 5.2 AS battery pack, rapid charger TCL 6	201390
TSC 55 Li 5,2 REB-Plus-SCA GB 2 x BP 18 Li 5.2 AS battery pack, SCA 8 rapid charger	201397
TSC 55 Li 5,2 REB-Set-FS GB 2 x BP 18 Li 5.2 AS battery pack, SCA 8 rapid charger, guide rail FS 1400/2	201401
TSC 55 Li 5,2 REB-Plus/XL GB 2 x BP 18 Li 5.2 AS battery pack, 2 x rapid charger TCL 6	201392
TSC 55 Li 5,2 REB-Plus/XL-SCA GB 2 x BP 18 Li 5.2 AS battery pack, 2 x SCA 8 rapid charger	201490
TSC 55 Li 5,2 REB-Set/XL-FS GB 2 x BP 18 Li 5.2 AS battery pack, 2 x SCA 8 rapid charger, guide rail FS 1400/2	201489

Sawing perfection with no compromises – except the socket.

Operates with the precision of the corded version but replaces the electrical socket with a high-endurance double-battery system. This enables users to quickly and easily achieve perfect results with the level of quality they have come to expect, even when working without access to power sockets.

System accessories from page 64

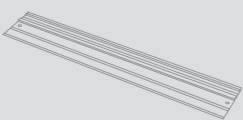

Circular saw blades from page 80



Battery and charging technology from page 10 onwards

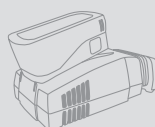

Sawing and oscillating

Circular saw TS 75



TS 75



75 mm cuts and no competition.

The cutting depth of 75 mm and the famous circular principle are ideal for jobs involving larger workpieces and enable you to saw thick workpieces with one cut. This saves you having to turn the workpiece and minimises reworking.



Large saw with depth.

- ▶ 75 mm cutting depth for even more application possibilities
- ▶ FastFix: quick and easy saw blade changing and adapting to the working material
- ▶ Safe and convenient – with sliding clutch and kickback stop
- ▶ Spring-loaded spacer wedge for unhindered plunge cuts

Technical data

Power consumption (W)	1.600
Idle engine speed (min ⁻¹)	1.350 – 3.550
Saw blade diameter (mm)	210
Angular range (°)	0 – 47
Cutting depth (mm)	0 – 75
Cutting depth 45° (mm)	55
Dust extraction connection dia. (mm)	27/36
Weight (kg)	6,2



= MMC Multi Material Control electronics

Items included	Order no.
HW universal saw blade W 36, splinterguard, operation tool, in SYSTAINER SYS 5 T-LOC	
TS 75 EQ-Plus GB 110V	561439
TS 75 EQ-Plus-FS GB 110V guide rail FS 1400/2	561259
TS 75 EBQ-Plus GB 240V set-back stop FS-RSP	561441
TS 75 EBQ-Plus-FS GB 240V set-back stop FS-RSP, guide rail FS 1400/2	561514

System accessories from page 64

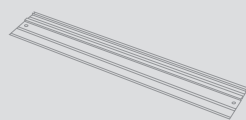

Circular saw blades from page 80





CMS-TS

Circular saw for the CMS system.

- ▶ Module carrier for installing plunge-cut saws to form a bench saw module
- ▶ Also available with plunge-cut saw
- ▶ Circular saws can be installed or used portably
- ▶ Flexible extension options – for an even wider range of applications



Technical data	CMS-MOD-TS 55 R	CMS-MOD-TS 75
Power consumption (W)	1.200	1.600
Idle engine speed (min ⁻¹)	2.000 – 5.200	1.350 – 3.550
Saw blade diameter (mm)	160	210
Cutting height 90°/45° (mm)	0 – 51/0 – 38	0 – 70/0 – 48
Dust extraction connection dia. (mm)	27/36	27/36
Dimensions module support (mm)	578 x 320	578 x 320
Weight module support (kg)	3,3	3,3
Max. working width for trimming cuts (mm)		
Weight (kg)	7,8	9,5
Max. working width longitudinal (mm)		
Table dimensions (mm)		

■ = MMC Multi Material Control electronics

Items included	Order no.
protective cover with supporter, fixing clamps, angle stop, scales, workpiece holder, cutting depth adjustment, clamp for switch and splitting wedge, in carton	
CMS-TS 55 R	570281
CMS-TS 75	493360

A workshop does not have to be big.

With the CMS modules, plunge-cut saws can be transformed into bench saws for a wide range of applications. Rip, cross and angled cuts as well as changing quickly from rip to cross cuts is so quick and easy. The transparent protective hood provides a good view of the workpiece and cut.

CMS system overview from page 396



Circular saw blades from page 80



Sawing and oscillating

HK 55 portable circular saw

HK 55



Flexibility in timber construction.

The versatile saw solution with high performance and maximum system precision. Guided cuts in combination with connectible FSK cross cutting guide rails.

Versatility for timber construction.

- ▶ High-torque 1200 W motor with power electronics ensures constant power when sawing
- ▶ Safe and easy handling thanks to the cutting depth adjustment with plunge function, pendulum hood remote control and guide wedge
- ▶ Angle adjustment with central clamping mechanism from 0 to 50 degrees
- ▶ Sawing system: HKC complete with FSK cross cutting guide rail and FS guide rail

Technical data

Power consumption (W)	1.200
Idle engine speed (min ⁻¹)	2.000 – 5.200
Saw blade diameter (mm)	160
Angular range (°)	0 – 50
Cutting depth 0°, 90° (mm)	0 – 55
Cutting depth 45°/50° (mm)	42/38
Dust extraction connection dia. (mm)	27/36
Weight (kg)	4,4



= MMC Multi Material Control electronics

Items included	Order no.
HW standard saw blade W18, operation tool, in SYSTAINER SYS 4 T-LOC	
HK 55 EQ-Plus GB 110V	561760
HK 55 EQ-Plus-FS GB 110V guide rail FS 1400/2	574677
HK 55 EQ-Plus-FSK420 GB 110V FSK 420 trimming rail	574682
HK 55 EBQ-Plus GB 240V	561759
HK 55 EBQ-Plus-FS GB 240V guide rail FS 1400/2	574676
HK 55 EBQ-Plus-FSK420 GB 240V FSK 420 trimming rail	574681

System accessories from page 65



Circular saw blades from page 80



Sawing and oscillating

HKC 55 cordless portable circular saw

02



Brushless EC-TEC motor for a long service life and a high level of efficiency



HKC 55

Standalone in every situation.

- ▶ 18V Li-ion battery and connectable cross cutting guide rails ensure mobility and independence
- ▶ Brushless EC-TEC motor combined with lithium-ion batteries for max cutting power
- ▶ In conjunction with the trimming rail, fast, accurate and mobile cross cuts
- ▶ Safe and easy handling thanks to the cutting depth adjustment with plunge function, pendulum hood remote control and guide wedge

Technical data

Battery voltage [V]	18
Idle engine speed [min ⁻¹]	4.500
Saw blade diameter [mm]	160
Angular range [°]	0 – 50
Cutting depth 0°, 90° [mm]	0 – 55
Cutting depth 45°/50° [mm]	42/38
Dust extraction connection dia. [mm]	27/36
Li-ion battery capacity [Ah]	5,2
Weight with Li-ion [kg]	4,1



■ = Electronic

Items included	Order no.
HW standard saw blade W18, operation tool, in SYSTAINER SYS 4 T-LOC	
HKC 55 Li EB-Basic without battery pack, without charger	201358
HKC 55 Li 5,2 EB-Plus GB 2 x BP 18 Li 5.2 AS battery pack, rapid charger TCL 6	201361
HKC 55 Li 5,2 EB-Plus-SCA GB 2 x BP 18 Li 5.2 AS battery pack, SCA 8 rapid charger	201370
HKC 55 Li 5,2 EB-Set-FSK420 GB SCA 8 rapid charger, 2 x BP 18 Li 5.2 AS battery pack, FSK 420 trimming rail	201373
HKC 55 Li 5,2 EB-Set-FS GB 2 x BP 18 Li 5.2 AS battery pack, guide rail FS 1400/2, SCA 8 rapid charger	201376



More independence. More precision.

For more mobility in timber construction: The cordless HKC 55 portable circular saw with FSK cross cutting guide rail demonstrates what saws are now capable of achieving on roofs – without sockets and cable pulling. Connecting this to the FSK cross cutting guide rail instantly produces a portable and easily manageable compound mitre saw system for accurate and precisely angled cuts.

System accessories from page 65



Circular saw blades from page 80



Battery and charging technology from page 10 onwards

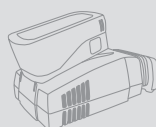

Sawing and oscillating

HK 85 portable circular saw



HK 85



Exclusive: Groove cutter included.

This is made possible using the optional adjustable groove cutter conversion kit – just a few steps and the HK 85 portable circular saw is transformed into a high-performance groove cutter. Ideal for longitudinal and transverse grooves, such as milling grooves for struts between rafters and intermediate ceilings.



The timber construction all-rounder.

- ▶ High-torque 2300 W motor with power electronics ensures constant power when sawing
- ▶ Safe and easy handling thanks to the cutting depth adjustment with plunge function, pendulum hood remote control and guide wedge
- ▶ Angle adjustment with central clamping mechanism from 0 to 60 degrees
- ▶ Using the conversion kit accessories, the portable circular saw can become a groove cutter

Technical data

Power consumption (W)	2.300
Idle engine speed (min ⁻¹)	1.500 – 3.300
Saw blade diameter (mm)	230
Angular range (°)	0 – 60
Cutting depth 0°, 90° (mm)	0 – 85
Cutting depth at 45°/60° (mm)	62/47
Dust extraction connection dia. (mm)	27/36
Weight (kg)	7



= MMC Multi Material Control electronics

Items included

HW standard saw blade W24, parallel side fence, operation tool, in SYSTEMER SYS 5 T-LOC

HK 85 EB-Plus GB 240V

Order no.

574669

HK 85 EB-Plus-FS GB 240V

guide rail FS 1400/2

574664

HK 85 EB-Plus-FSK420 GB 240V

FSK 420 trimming rail

574668

System accessories from page 66



Circular saw blades from page 80



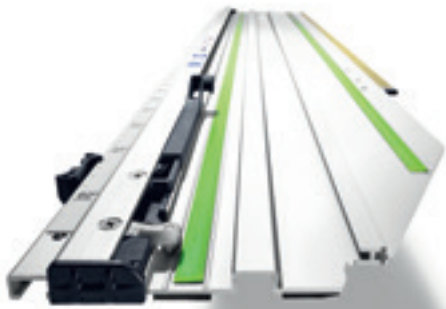

FSK

Not just saws—compound mitre saws.

- ▶ The HK 55, HKC 55 and HK 85 portable circular saws can be easily connected to the cross cutting guide rail to form a single unit, by means of a quick fastener
- ▶ The compound mitre saw system makes work easier with fast, guided and precisely-angled cross cuts
- ▶ Stop system for accurately repeated angled cuts
- ▶ Retract function returns the saw to start position after sawing

Technical data	FSK 250	FSK 420	FSK 670
Cutting length (mm)	250	420	670
Angular range [°]	-45 – +60	-60 – +60	-60 – +60
Weight (kg)	0,98	1,26	1,63



Items included	Order no.
in carton	
FSK 250	769941
FSK 420	769942
FSK 670	769943

Click – and go.

The HK 55, HKC 55 and HK 85 Festool circular saws can easily be connected to the FSK cross cutting guide rails, which are available in three different lengths. In just a few steps, this produces a portable and easy-to-use compound mitre saw system for accurate and precisely angled cutting, in just a few steps.

Sawing and oscillating

Carpentry portable circular saw HK 132



HK 132



3-in-1. Saw, notch cutter, flattening planer.

- ▶ Trouble-free retraction control of the movable guard, particularly of benefit for mitre cutting
- ▶ Accurate, fixed adjustment for mitre-cutting up to 60°
- ▶ Electronic convenience: Soft start, constant speed, overload protection and coil temperature monitoring
- ▶ Stable and exact guidance by means of the guide system: parallel fence, guide plate extension, parallel fence for guide rail

Technical data	HK 132	HK 132/RS-HK	HK 132/NS-HK
Power consumption (W)	2.300	2.300	2.300
Idle engine speed (min ⁻¹)	2.200	2.200	2.200
Cutting depth 0°, 90° (mm)	50 – 132	50 – 132	50 – 132
Cutting depth at 45°/60° (mm)	85/50	85/50	85/50
Mitre cuts (°)	0 – 60	0 – 60	0 – 60
Weight (kg)	18	18	18
Max. routing width (mm)		80	
Max. routing depth (mm)		0 – 38	
Max. planing width (mm)			50
Max. planing depth (mm)			80



☐ = Electronic

not available in Great Britain

Three in one.

On the one hand, a portable circular saw with a cutting depth of 132 mm. Replace the saw blade with a notch cutter and the HK 132 becomes a reliable milling machine. Retrofitting on the planer is also easy.

System accessories
from page 67

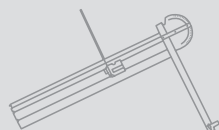

Circular saw blades
from page 80



 GOLD
AWARD
2017

KAPEX KS 60



Mobility, versatility and best results – perfectly combined.

- ▶ Compact and lightweight, with ergonomic handles and cord holder
- ▶ LED spotlight to show cutting lines precisely
- ▶ Bevel for producing interior and exterior angles
- ▶ Inclination angle of up to 47°/46° on each side and mitre angle of up to 60° on each side

Technical data

Power consumption (W)	1.200
Idle engine speed (min ⁻¹)	1.300 – 3.500
Saw blade diameter (mm)	216
Cutting depth 90°/90° (mm)	305 x 60
Cutting depth at 45°/90° (mm)	215 x 60
Cutting depth 45°/45° (left) (mm)	215 x 40
Inclination angle (°)	47/46
Mitre angle (°)	60/60
Dimensions (W x D x H) (mm)	661 x 475 x 430
Dust extraction connection dia. (mm)	27/36
Weight (kg)	17,8



■ = MMC digital electronics

Items included

	Order no.
HW universal saw blade W 36, clamp FSZ 120, operation tool, in carton	
KS 60 E GB 240V	561684
KS 60 E GB 110V	561685
KS 60 E-SET GB 240V	561729
LED spotlight, Bevel, elevation	
KS 60 E-SET GB 110V	561693
LED spotlight, Bevel, elevation	
KS 60 E-Set-UG GB 240V	575339
LED spotlight, Bevel, elevation, underframe	
KS 60 E-Set-UG GB 110V	575341
LED spotlight, Bevel, elevation, underframe	
KS60E-Set/XL-UG GB 240V	575340
LED spotlight, Bevel, elevation, underframe, KS-UG-KS R/L trimming attachment, adjustable stop, telescopic slide-out scale, fold-out pedestal and carry case	
KS60E-Set/XL-UG GB 110V	575342
LED spotlight, Bevel, elevation, underframe, KS-UG-KS R/L trimming attachment, adjustable stop, telescopic slide-out scale, fold-out pedestal and carry case	

Ideal for mobile use.

With the maximum range of applications for assembly: For cutting boards and panels with sizes of up to 305 x 60 mm to length, trimming strips, profiles and square timber at thicknesses of up to 60 mm and adjusting skirting boards and cover strips to precision angles quickly and precisely using the bevel.

System accessories from page 68

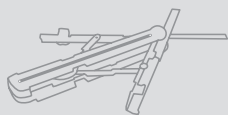

Circular saw blades from page 80



Sawing and oscillating

Sliding compound mitre saw KAPEX KS 88



KAPEX KS 88



Flexible frame.

Comfortable operation also for assembly work – the frame is a stand and transport frame in one. Precise work of up to 2.4 m cutting length with arm and easy to transport thanks to rollers and handle.

Less weight, but better performance.

- ▶ Twin-column guide with two bearings for unique precision
- ▶ Compact, lightweight design for convenient transportation
- ▶ Intelligent details such as an angle preselection and quick-release clamp for rapid adjustment of the inclination angle
- ▶ FastFix saw blade changing for adaptation to the working material

Technical data

Power consumption (W)	1.600
Idle engine speed (min ⁻¹)	1.400 – 3.400
Saw blade diameter (mm)	260
Cutting depth 90°/90° (mm)	305 x 88
Cutting depth at 45°/90° (mm)	215 x 88
Crown moulding diagonal cut 45°/90° (mm)	168
Inclination angle (°)	47/47
Mitre angle (°)	50/60
Dimensions (W x D x H) (mm)	713 x 500 x 470
Dust extraction connection dia. (mm)	27/36
Weight (kg)	20,7



■ = MMC digital electronics

Items included

HW universal saw blade W60, workpiece clamp, operation tool, in carton

KS 88 E GB 240V

Order no.

561400

KS 88 E GB 110V

561399

System accessories from page 69

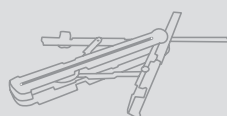

Circular saw blades from page 80





KAPEX KS 120

**Quality down to the finest detail.**

- ▶ Twin-column guide with two bearings for unique precision
- ▶ Dual-line laser for an accurate indication of the cutting line
- ▶ Fine adjustment of the saw blade angle accurate to the millimetre from the front of the machine
- ▶ Special cutting position for cutting depths up to 120 mm

Technical data

Power consumption (W)	1.600
Idle engine speed (min ⁻¹)	1.400 – 3.400
Saw blade diameter (mm)	260
Cutting depth 90°/90° (mm)	305 x 88
Cutting depth at 45°/90° (mm)	215 x 88
Special cutting depth 90°/90° (mm)	60 x 120
Crown moulding diagonal cut 45°/90° (mm)	168
Inclination angle [°]	47/47
Mitre angle [°]	50/60
Dimensions (W x D x H) (mm)	713 x 500 x 470
Weight (kg)	21,5



■ = MMC digital electronics

Items included	Order no.
HW universal saw blade W60, Bevel, workpiece clamp, operation tool, in carton	
KS 120 EB GB 240V	561285
KS 120 EB GB 110V	561286
KS 120 EB Set GB 240V multifunction table MFT KAPEX, clamping set, 2 x Trimming attachment, 2 x Crown stop	561291
KS 120 EB Set GB 110V multifunction table MFT KAPEX, clamping set, 2 x Trimming attachment, 2 x Crown stop	561292
KS 120 UG-Set GB 240V KS 120 EB, underframe, adjustable stop, telescopic slide-out scale, fold-out pedestal and carry case	561417
KS 120 UG-Set GB 110V KS 120 EB, underframe, adjustable stop, telescopic slide-out scale, fold-out pedestal and carry case	561418

Maximum precision for the perfect cut.

The impressive features of the KS 120 include an outstanding cutting capacity and low weight. The special cutting position allows you to cut coving and cornices in their original wall position. Intelligent details such as the dual-line laser and bevel ensure accurate results.

System accessories from page 69**Circular saw blades from page 80**

Sawing and oscillating

Compound mitre saw SYMMETRIC SYM 70



SYMMETRIC SYM 70



Trimming strips could not be easier.

Precision has never been easier: measure and transfer the angle, make the cut and you're done. The patented symmetrical stop system on the SYMMETRIC SYM 70 simplifies your work considerably.

Compound mitre saw.

- ▶ Patented symmetrical stop system
- ▶ Easy angle transfer using a bevel, cutting along the bisector without making calculations
- ▶ Stops easy to clamp, no tools required
- ▶ MMC electronics adapt to the working material

Technical data

Power consumption (W)	1.150
Idle engine speed (min ⁻¹)	2.700 – 5.200
Saw blade diameter (mm)	216
Interior angle (°)	0 – 68
Exterior angle (°)	0 – 60
Max. strip height (mm)	70
Max. strip width (mm)	80
Dust extraction connection dia. (mm)	27/36
Weight (kg)	9,5



■ = MMC Multi Material Control electronics

Items included

SYM 70 E GB 240V
fine tooth saw blade HW W48, precision adjustable square, clamp FSZ 120, operation tool, in carton

Order no.

561256

System accessories from page 70



Circular saw blades from page 80



Sawing and oscillating

Trimming saw PRECISIO CS 50

02



PRECISIO CS 50

Full power perfectly under control.

- ▶ Tool-less FastFix saw blade changes
- ▶ Multifunction handle: one handle with all functions integrated
- ▶ Change quickly from rip to cross cuts with the angle stop
- ▶ Moving splinterguard for splinter-free cuts on both sides

Technical data	CS 50	CS 50 Set
Power consumption [W]	1.200	1.200
Idle engine speed [min ⁻¹]	1.600 – 4.200	1.600 – 4.200
Saw blade diameter (mm)	190	190
Cutting height 90°/45° (mm)	0 – 52/0 – 37	0 – 52/0 – 37
Inclination (°)	0 [-2]° – 45 [+47]	0 [-2]° – 45 [+47]
Cutting path (mm)	304	304
Table dimensions (mm)	585 x 400	1.010 x 810
Table height, legs folded away (mm)	316	316
Table height, legs unfolded (mm)	900	900
Dust extraction connection dia. (mm)	27/36	27/36
Weight (kg)	17,4	41,3



■ = MMC digital electronics

Items included	Order no.
HW universal saw blade W32, angle stop, foldaway legs, 3 x splinterguard, dust extraction set, workpiece holder, operation tool, in carton	
CS 50 E GB 110V	561196
CS 50 EB GB 240V	561194
CS 50 EB-Set GB 240V ripping-cut fence, sliding table, extension table, extension table	561202



Diversity made easy.

The PRECISIO CS 50 is the perfect solution for cross and rip cuts in applications involving interior fitting, furniture assembly and exhibition stand construction. Thanks to its low weight and a host of ingenious functions, the CS 50 is ideal for applications where the nature of the work constantly changes, e.g. assembly tasks.

System accessories from page 71

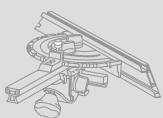

Circular saw blades from page 80



Sawing and oscillating

Trimming saw PRECISIO CS 70



PRECISIO CS 70



Like a knife through butter.

The size and power of the CS 70 really begins to show when cutting workpieces up to 70 mm thick, both in the workshop and on assembly sites. Comprehensive system accessories allow you to upgrade the CS 70 to a complete sawing station.

Solid, strong and uncompromising.

- ▶ 2200 watt universal motor for powerful cutting
- ▶ 70 mm cutting depth for an even wider range of applications
- ▶ Change quickly from rip to cross cuts with the angle stop
- ▶ Moving splinterguard for splinter-free cuts on both sides

Technical data	CS 70	CS 70 Set
Power consumption [W]	2.200	2.200
Idle engine speed [min ⁻¹]	2.000 – 4.200	2.000 – 4.200
Saw blade diameter [mm]	225	225
Cutting height 90°/45° [mm]	0 – 70/0 – 48	0 – 70/0 – 48
Inclination [°]	0 [-2]° – 45 [+47]	0 [-2]° – 45 [+47]
Cutting path [mm]	320	320
Table dimensions [mm]	690 x 500	1.260 x 910
Table height, legs folded away [mm]	375	375
Table height, legs unfolded [mm]	900	900
Dust extraction connection dia. [mm]	27/36	27/36
Weight [kg]	34,5	66



 = MMC Multi Material Control electronics

Items included	Order no.
HW universal saw blade W32, angle stop, workpiece holder, operation tool, in carton	
CS 70 E GB 110V	561257
CS 70 E-Set GB 110V sliding table, extension table CS 70 VB, extension table CS 70 VL, ripping-cut fence, 3 x splinterguard, dust extraction set	561310
CS 70 EB GB 240V 3 x splinterguard, dust extraction set	561254
CS 70 EB-Set GB 240V sliding table, extension table CS 70 VB, extension table CS 70 VL, ripping-cut fence, 3 x splinterguard, dust extraction set	561253

System accessories from page 72

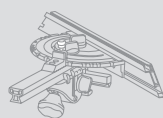

Circular saw blades from page 80





SSU 200



Small handy machine with 200 mm cutting depth.

- ▶ 200 mm cutting depth and 6.5 kg weight
- ▶ Integrated guide slot in the aluminium die cast base plate for accurate cuts using the guide rail
- ▶ Wide application range for mitre cuts up to 60°
- ▶ Chain changed and tensioned without using tools

Technical data

Power consumption [W]	1.600
Idle engine speed [min ⁻¹]	4.600
Cutting depth 0°, 90°/45°/60° [mm]	200/140/100
Mitre cuts [°]	0 – 60
Cutting speed (idling) [m/s]	10,6
Blade position [°]	0 – 10
Weight [kg]	6,5



■ = MMC Multi Material Control electronics

Items included	Order no.
universal saw chain SC 3/8" 91 U-39E, chain oil 250 ml, 7.5 m power cord, in SYSTAINER SYS 5 T-LOC	
SSU 200 EB-Plus GB 240V	769211
SSU 200 EB-Plus-FS GB guide rail FS 800/2	769212

Precise cut.

Whether it is wood or insulating material, the UNIVERS SSU 220 sword saw cuts all common materials in wooden structures up to 200 mm thick.

System accessories
from page 73



Sawing and oscillating

Sword saw IS 330



IS 330



The specialist for cutting insulating materials.

The sword saw IS 330 combines the advantages of a chain saw and a portable circular saw with a guide rail in a unique mobile system. Cutting pressure-resistant insulating materials such as wood fibre and PU boards is this easy, quick and accurate thanks to the guide rail.

The size with 330 mm cutting depth.

- ▶ Ideal for construction sites: cutting depth of 330 mm for cutting thick insulating materials to size and 7.0 kg in weight
- ▶ 60° mitre cutting angle with a cutting depth of 165 mm
- ▶ Straight and splinter-free cuts thanks to guide rails
- ▶ Rotary dust-extraction attachment for connecting an extractor

Technical data

Power consumption (W)	1.600
Idle engine speed (min ⁻¹)	4.600
Cutting depth 0°, 90°/45°/60° (mm)	330/230/165
Mitre cuts (°)	0 – 60
Cutting speed (idling) (m/s)	12
Blade position (°)	0 – 10
Weight (kg)	7



☐ = MMC Multi Material Control electronics

not available in Great Britain

System accessories
from page 73





VECTURO OS 400

Equipped with a decisive additional feature: accuracy.

- ▶ Powerful 400 watt motor with electronic speed control for consistently fast working progress
- ▶ Ergonomic: The slimline housing with rubber-coated handle fits perfectly in your hand
- ▶ Depth stop for greater accuracy and for precise sawing on the scribe mark – ideal for cut-outs in delicate surfaces
- ▶ Flexible use, short set-up times: Blades and accessories are replaced without the need to use any tools

Technical data

Power consumption (W)	400
Power output (W)	220
Vibrations (min ⁻¹)	11.000 – 18.500
Amplitude (°)	2
Cable length (m)	5
Weight (kg)	1,6



■ = Electronic

Items included	Order no.
universal saw blade USB 78/32/Bi, in SYSTAINER SYS 2 T-LOC DF	
OS 400 E-Plus GB 240V	575353
OS 400 E-Plus GB 110V	575355
OS 400 E-Set GB 240V	575354
HSB 50/35/J wood saw blade, wood saw blade HSB 100/HCS, positioning aid/depth stop set OS-AH/TA Set	
OS 400 E-Set GB 110V	575356
HSB 50/35/J wood saw blade, wood saw blade HSB 100/HCS, positioning aid/depth stop set OS-AH/TA Set	



Greater accuracy in every position.

Precise cuts along the scribe mark with the positioning aid, defined cuts with depth stop that can be adjusted without the need for a tool or flush cuts to the wall with a sliding shoe that can also be mounted without a tool. Whether it is wood, non-ferrous metals, composite materials or silicone: Innovative accessories complement the VECTURO to achieve the ultimate precision.

System accessories from page 84

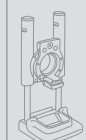

Saw blades from page 85



Sawing and oscillating

Innovative accessories for decisive precision.



Ideal for long, straight cuts in wood to a defined depth:
the depth stop with sliding shoe and circular saw blade.



For plunge cuts with a defined depth:
the depth stop – mounted quickly without any tools.



Accurate sawing along the scribe mark with the positioning aid:

ideal for cut-outs on sensitive surfaces, notches, cutouts and plunge cuts in wood, composite materials, coated materials and non-ferrous metals. Installed quickly and without any tools thanks to FastFix. Both the VECTURO in the positioning aid and the saw blade itself can be rotated from $+90^\circ$ to -90° in 30° increments.



Better cutting everywhere:

with the special saw blades for windows, putty and plastics and the scrapers for adhesive residues and silicones.



The special knife for the window industry:
for removing putty from window glazing.



Simply scrape:
Removal of adhesive residues or silicone.



Right up to the edge:
with the offset saw blade.

1 x register. 4 x benefits.

Make sure you bear this in mind when purchasing your next tool, and register your tool within 30 days after purchasing it. The easiest way to do so is online at www.festool.co.uk/register or at your specialist retailer.

And we promise – SERVICE all-inclusive means service, no ifs, no buts.

- ▶ 36 months of free of charge repairs*.
- ▶ 36 months of theft protection.
- ▶ 10-year replacement parts guarantee.
- ▶ 15 days money back guarantee.

So don't forget: Purchase your tool, register it immediately, then work without worrying.

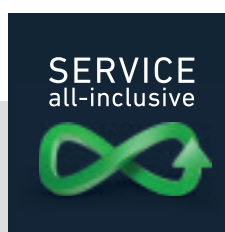

www.festool.co.uk/register
Enter tool data. Confirm. And enjoy everything our SERVICE all-inclusive has to offer.

You can find more information on SERVICE all-inclusive, the service conditions and their applicability on the Internet at www.festool.co.uk/service

SERVICE all-inclusive applies to all machines registered within 30 days of purchase and purchased on or after 2nd April 2013.

*Free-of-charge repairs do not apply to damage to consumables and accessories, improper use, damage caused by the use of non-original accessories or spare parts, and in the event that tools are dismantled by the user themselves or continuously subjected to use resulting in extensive wear.

The Festool system.

Because things work better when everything fits together: Festool saws fit perfectly into the system. For example, the guide rails are compatible both with pendulum jigsaws and plunge-cut saws. Bevels can be used for multiple functions and a hand-guided saw can also be used in a semi-stationary configuration with the CMS Compact Module System.



Sawing and oscillating

Accessories and consumable materials

System accessories	62
Saw blades	76
Saw blades	80
Saw blades, oscillators	85



Sawing and oscillating

System accessories

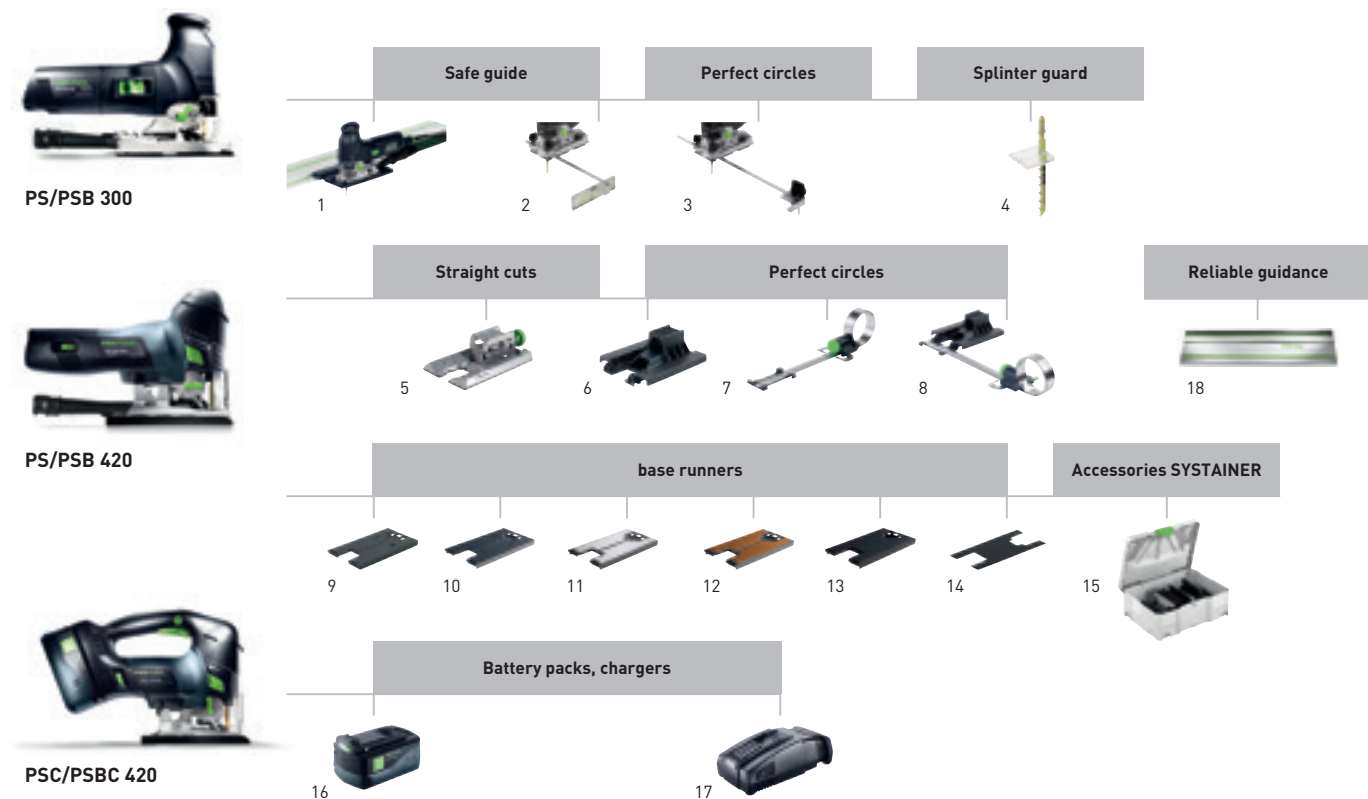

Accessories for pendulum jigsaws PS/PSB 300, PS/PSB 420, PSC/PSBC 420

Denomination	Explanation	Order no.
1 Guide rail adapter FS-PS/PSB 300	for PS 200, PS 300, PSB 300, PS 2, allows use of jigsaws with FS and FS/2 guide systems, in self-service display pack	490031
2 Parallel side fence PA-PS/PSB 300	for PS 300, PSB 300, PS200, PS2, max. workpiece width 200 mm, in self-service display pack	490119
3 Core maker KS-PS/PSB 300	for PS 300, PSB 300, PS200, PS2, circle dia. 130 – 720 mm, in self-service display pack	490118
4 Splinter guard SP-PS/PSB 300/5	for PS 300, PSB 300, PS(C) 400/420, PSB(C) 400/420, prevents splintering, qty. in pack 5 piece(s), in self-service display pack	490120
Splinter guard SP-PS/PSB 300/20	for PS 300, PSB 300, PS(C) 400/420, PSB(C) 400/420, prevents splintering, qty. in pack 20 piece(s), in self-service display pack	490121
Splinter guard SP-PS/5	for PS1, PS 2, PS200, prevents splintering, qty. in pack 5 piece(s), in self-service display pack	483372
5 Angle table WT-PS 420	for PS(C) 400/420, PSB(C) 400/420, for angled cuts from +45° to -45°, stepless angle adjustment, in self-service display pack	496134
6 Adapter table ADT-PS 420	for PS(C) 400/420, PSB(C) 400/420, for using the PS on the guide rail, for installation in the Compact Module System CMS, in conjunction with circle cutting attachment KS-PS 400, in self-service display pack	497303
7 Core maker KS-PS 420	for PS(C) 400/420, PSB(C) 400/420, circle dia. from 120 mm – 3 m, in conjunction with adapter table ADT-PS 400, in self-service display pack	497304
8 Core maker KS-PS 420 Set	for PS(C) 400/420, PSB(C) 400/420, circle dia. from 120 mm – 3 m, incl. adapter table ADT-PS 420, in self-service display pack	497443
9 Base runner LAS-PS 420	for PS(C) 400/420, PSB(C) 400/420, plastic all-round base for wood or similar materials, in self-service display pack	497297
10 Base runner LAS-Soft-PS 420	for PS(C) 400/420, PSB(C) 400/420, studded base with optimum sliding properties for wood or similar materials, in self-service display pack	497298
11 Base runner LAS-HGW-PS 420	for PS(C) 400/420, PSB(C) 400/420, durable laminated fabric base for wood or similar materials, in self-service display pack	497299
12 Base runner LAS-St-PS 420	for PS(C) 400/420, PSB(C) 400/420, for all metallic materials, in self-service display pack	497300
13 Base runner LAS-STF-PS 420	for PS(C) 400/420, PSB(C) 400/420, for sensitive surfaces, in self-service display pack	497301
14 Spare felt EF-LAS-STF-PS 420	for PS(C) 400/420, PSB(C) 400/420, 5x spare felt for StickFix LAS-STF-PS 420 base runner, in self-service display pack	497444
15 Accessories SYS ZH-SYS-PS 420	for PS(C) 400/420, PSB(C) 400/420, 5 splinterguards, Soft base runner, Hard base runner, Steel base runner, StickFix baseplate, angle table, base adapter, core maker, StickFix felt, in SYSTAINER SYS 2 T-LOC	497709

Accessories for pendulum jigsaws PS/PSB 300, PS/PSB 420, PSC/PSBC 420

Denomination	Explanation	Order no.
16 Battery pack BP 18 Li 5,2 AS	with AIRSTREAM function, lithium-ion (Li-ion) replacement battery pack for all Festool 18 V cordless tools (except CXS/TXS), tensioner 18 V, capacity 5,2 Ah, weight 0,7 kg, in self-service display pack	200181
Battery pack BP 18 Li 5,2 AS-ASI	Bluetooth lithium-ion (Li-ion) battery pack with AIRSTREAM function for all Festool 18 V cordless tools (except CXS/TXS), Bluetooth enables the CLEANTEC mobile dust extractor to be started automatically when the cordless tool is switched on (use of the Bluetooth module at the free slot on the CLEANTEC mobile dust extractor is required), tensioner 18 V, capacity 5,2 Ah, weight 0,7 kg, in carton	202479
Battery pack BP 18 Li 6,2 AS-ASI	Bluetooth lithium-ion (Li-ion) battery pack with AIRSTREAM function for all Festool 18 V cordless tools (except CXS/TXS), Bluetooth enables the CLEANTEC mobile dust extractor to be started automatically when the cordless tool is switched on (use of the Bluetooth module at the free slot on the CLEANTEC mobile dust extractor is required), tensioner 18 V, capacity 6,2 Ah, weight 0,7 kg, in carton	201797
Battery pack BP 18 Li 3,1 C	compact, lightweight design, lithium-ion (Li-ion) replacement battery pack for all Festool 18 V cordless tools (except TSC 55, CXS/TXS), tensioner 18 V, capacity 3,1 Ah, weight 0,4 kg, in self-service display pack	201789
17 Rapid charger TCL 6 GB 240V	for all Li-ion battery packs (except for CXS/TXS), Lithium-ion (Li-ion) replacement charger for all 10.8 – 18 V battery packs, charging current 6 A, input voltage 220 – 240 V, weight 0,8 kg, in self-service display pack	201136
Rapid charger SCA 8 GB 240V	for all Li-ion battery packs (except for CXS/TXS), with AIRSTREAM function, Lithium-ion (Li-ion) replacement charger for all 10.8 – 18 V battery packs, charging current 8 A, input voltage 220 – 240 V, weight 1,1 kg, in self-service display pack	200311
Battery and charging technology	from page 10	
18 Guide-rails	see the "Organising your workplace" chapter from page 400	

Sawing and oscillating

System accessories

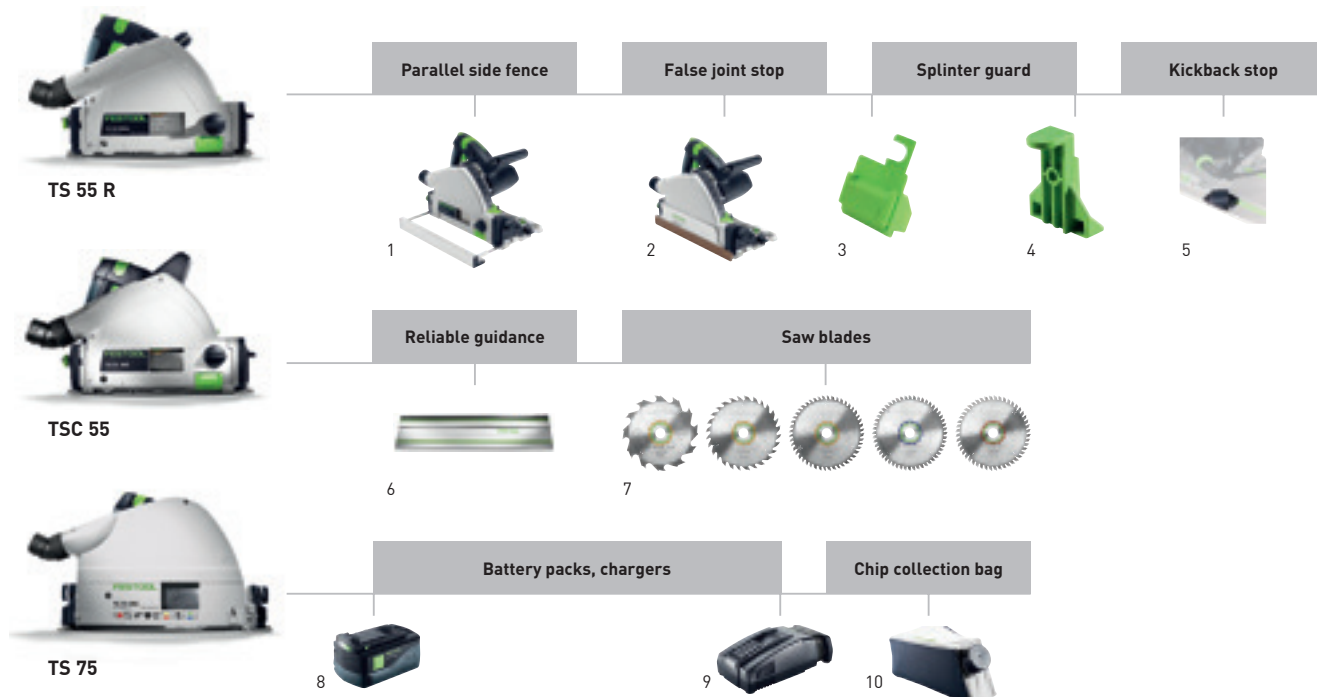

Accessories for circular saws TS 55 R, TSC 55, TS 75

Denomination	Explanation	Order no.
1 Parallel side fence PA-TS 55	for TS 55, TS 55 R, TSC 55, can also be used as table extension, parallel guide, guided on both sides, max. workpiece width 100 mm, in carton	491469
Parallel side fence PA-TS 75	for TS 75, parallel guide, guided on both sides, can also be used as table extension, max. workpiece width 100 mm, in carton	492243
2 Cover ABSA-TS 55	for TS 55, TS 55 R, TSC 55, can also be used as false joint set, cover for improved dust extraction, width of the shadow gap TS 55 15 – 46 mm, in carton	491750
3 Splinter guard SP-TS 55 R/5	for TS 55 R, TSC 55, can be used with or without guide rail, for low-splinter cuts to the right of the saw blade, qty. in pack 5 piece(s), in self-service display pack	499011
4 Splinter guard SP-TS 55/5	for TS 55, TS 75, for low-splinter cuts to the right of the saw blade, can be used with or without guide rail, qty. in pack 5 piece(s), in self-service display pack	491473
5 Kickback stop FS-RSP	for TS 55, TS 55 R, TSC 55, TS 75, HKC 55, HK 55, ATF 55, AP 55, AT 65, AP 65, AP 85, can also be used as guide stop, used as a rear and front stop position on guide rail FS/2, in self-service display pack	491582
6 Guide-rails	see the "Organising your workplace" chapter from page 400	
7 Saw blades	from page 80	
8 Battery pack BP 18 Li 5,2 AS	with AIRSTREAM function, lithium-ion (Li-ion) replacement battery pack for all Festool 18 V cordless tools (except CXS/TXS), tensioner 18 V, capacity 5,2 Ah, weight 0,7 kg, in self-service display pack	200181
Battery pack BP 18 Li 5,2 AS-ASI	Bluetooth lithium-ion (Li-ion) battery pack with AIRSTREAM function for all Festool 18 V cordless tools (except CXS/TXS), Bluetooth enables the CLEANTEC mobile dust extractor to be started automatically when the cordless tool is switched on [use of the Bluetooth module at the free slot on the CLEANTEC mobile dust extractor is required], tensioner 18 V, capacity 5,2 Ah, weight 0,7 kg, in carton	202479
Battery pack BP 18 Li 6,2 AS-ASI	Bluetooth lithium-ion (Li-ion) battery pack with AIRSTREAM function for all Festool 18 V cordless tools (except CXS/TXS), Bluetooth enables the CLEANTEC mobile dust extractor to be started automatically when the cordless tool is switched on [use of the Bluetooth module at the free slot on the CLEANTEC mobile dust extractor is required], tensioner 18 V, capacity 6,2 Ah, weight 0,7 kg, in carton	201797
9 Rapid charger TCL 6 GB 240V	for all Li-ion battery packs (except for CXS/TXS), Lithium-ion (Li-ion) replacement charger for all 10.8 – 18 V battery packs, charging current 6 A, input voltage 220 – 240 V, weight 0,8 kg, in self-service display pack	201136
Rapid charger SCA 8 GB 240V	for all Li-ion battery packs (except for CXS/TXS), with AIRSTREAM function, Lithium-ion (Li-ion) replacement charger for all 10.8 – 18 V battery packs, charging current 8 A, input voltage 220 – 240 V, weight 1,1 kg, in self-service display pack	200311
Battery and charging technology	from page 10	
10 Chip collection bag SB-TSC	For TSC 55, HKC 55, folds down for space-saving transportation, for all woods, with dust cap, in self-service display pack	500393



HK 55



HKC 55



Accessories for HK 55, HKC 55 portable circular saws

Denomination	Explanation	Order no.
1 Cross cutting guide rail FSK 250	for HKC 55, HK 55, HK 85, cutting length 250 mm, angular range -45 – +60°, weight 0,98 kg, in carton	769941
Cross cutting guide rail FSK 420	for HKC 55, HK 55, HK 85, cutting length 420 mm, angular range -60 – +60°, weight 1,26 kg, in carton	769942
Cross cutting guide rail FSK 670	for HKC 55, HK 55, HK 85, cutting length 670 mm, angular range -60 – +60°, weight 1,63 kg, in carton	769943
2 Bag FSK420-BAG	for FSK 250, FSK 420, transport bag with shoulder straps	200160
Bag FSK670-BAG	for FSK 670, transport bag with shoulder straps	200161
3 Circular saw blades	from page 80	
4 Kickback stop FS-RSP	for TS 55, TS 55 R, TSC 55, TS 75, HKC 55, HK 55, ATF 55, AP 55, AT 65, AP 65, AP 85, can also be used as guide stop, used as a rear and front stop position on guide rail FS/2, in self-service display pack	491582
5 Parallel side fence PA-HKC 55	for HKC 55, HK 55, can also be used as table extension, parallel guide, guided on both sides, in carton	500464
6 Guide-rails	see the "Organising your workplace" chapter from page 400	
7 Battery pack BP 18 Li 5,2 AS	with AIRSTREAM function, lithium-ion (Li-ion) replacement battery pack for all Festool 18 V cordless tools (except CXS/TXS), tensioner 18 V, capacity 5,2 Ah, weight 0,7 kg, in self-service display pack	200181
Battery pack BP 18 Li 5,2 AS-ASI	Bluetooth lithium-ion (Li-ion) battery pack with AIRSTREAM function for all Festool 18 V cordless tools (except CXS/TXS), Bluetooth enables the CLEANTEC mobile dust extractor to be started automatically when the cordless tool is switched on (use of the Bluetooth module at the free slot on the CLEANTEC mobile dust extractor is required), tensioner 18 V, capacity 5,2 Ah, weight 0,7 kg, in carton	202479
Battery pack BP 18 Li 6,2 AS-ASI	Bluetooth lithium-ion (Li-ion) battery pack with AIRSTREAM function for all Festool 18 V cordless tools (except CXS/TXS), Bluetooth enables the CLEANTEC mobile dust extractor to be started automatically when the cordless tool is switched on (use of the Bluetooth module at the free slot on the CLEANTEC mobile dust extractor is required), tensioner 18 V, capacity 6,2 Ah, weight 0,7 kg, in carton	201797
8 Rapid charger TCL 6 GB 240V	for all Li-ion battery packs (except for CXS/TXS), Lithium-ion (Li-ion) replacement charger for all 10.8 – 18 V battery packs, charging current 6 A, input voltage 220 – 240 V, weight 0,8 kg, in self-service display pack	201136
Rapid charger SCA 8 GB 240V	for all Li-ion battery packs (except for CXS/TXS), with AIRSTREAM function, Lithium-ion (Li-ion) replacement charger for all 10.8 – 18 V battery packs, charging current 8 A, input voltage 220 – 240 V, weight 1,1 kg, in self-service display pack	200311
Battery and charging technology	from page 10	
9 Chip collection bag SB-TSC	For TSC 55, HKC 55, folds down for space-saving transportation, for all woods, with dust cap, in self-service display pack	500393

Sawing and oscillating

System accessories

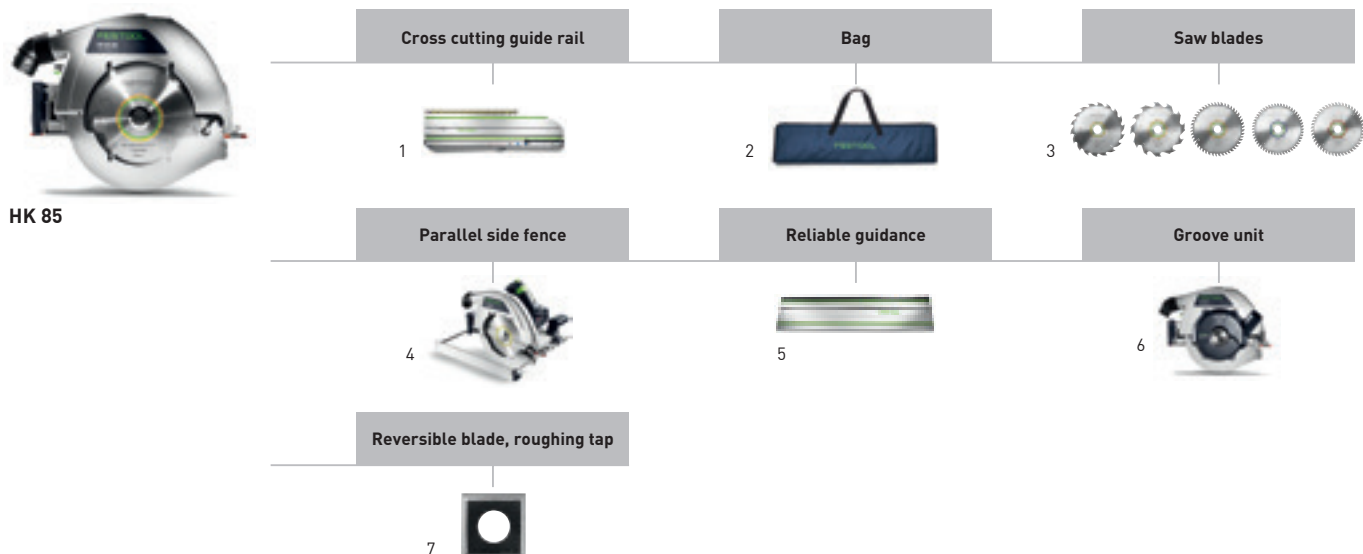

Accessories for HK 85 portable circular saws

Denomination	Explanation	Order no.
1 Cross cutting guide rail FSK 250	for HKC 55, HK 55, HK 85, cutting length 250 mm, angular range -45 – +60°, weight 0,98 kg, in carton	769941
Cross cutting guide rail FSK 420	for HKC 55, HK 55, HK 85, cutting length 420 mm, angular range -60 – +60°, weight 1,26 kg, in carton	769942
Cross cutting guide rail FSK 670	for HKC 55, HK 55, HK 85, cutting length 670 mm, angular range -60 – +60°, weight 1,63 kg, in carton	769943
2 Bag FSK420-BAG	for FSK 250, FSK 420, transport bag with shoulder straps	200160
Bag FSK670-BAG	for FSK 670, transport bag with shoulder straps	200161
3 Circular saw blades	from page 80	
4 Parallel side fence PA-HK 85	for HK 85, can also be used as table extension, parallel guide, guided on both sides, in carton	500645
Parallel side fence PA-A-HK 85	for HK 85, bilateral offset parallel stop, in carton	574670
5 Guide-rails	see the "Organising your workplace" chapter from page 400	
6 Groove unit VN-HK85 130x16-25	for HK 85, routing transverse and longitudinal grooves; routing depth 0-35 mm and routing width adjustable by 16-25 mm, reversible blades HW-WP 14x14x2, adjustable groove cutter diameter 130 x 16-25 mm, protective cover (fixed), protective cover (moveable), Clamping flange, Counter flange, Spacer, dust extraction connection dia. 36 mm, weight 0,9 kg, in SYSTAINER SYS 1 T-LOC	200163
7 Reversible blade HW-WP 14x14x2/12	for HK85 adjustable groove cutter, dimensions (L x W x H) 14 x 14 x 2 mm, qty. in pack 12 piece(s), in self-service display pack	574671



HK 132

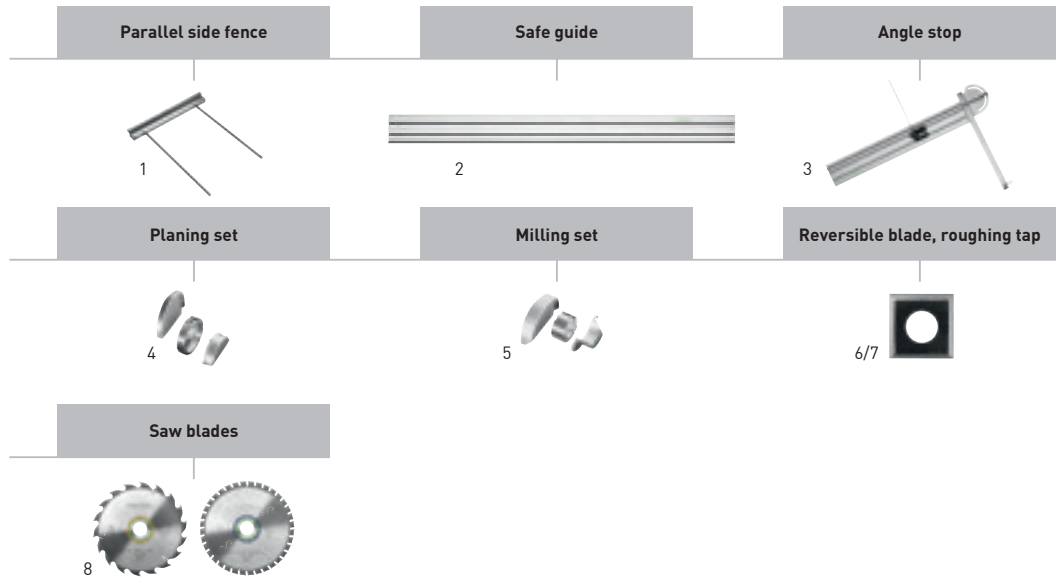

Accessories for carpentry portable circular saws HK 132

Denomination	Explanation	Order no.
1 Parallel side fence PG-HK 132	for HK 132, CSP 132, for using HK 132 E/W with guide rails, type GC 2000/3000, in carton	769538
2 Guide rail GC 2000	for HK 132, CSP 85/60, CSP 132, CSP 165, CCP 380, NRP 90, 2000 mm long, in wooden box	769669
Guide rail GC 3000	for HK 132, CSP 85/60, CSP 132, CSP 165, CCP 380, NRP 90, 3000 mm long, in wooden box	769670
3 Angle stop GC 1000-WA	for HK 132, CSP 85/60, CSP 132, CSP 165, CCP 380, NRP 90, angle indicator with 1000 mm guide rail and gauge marker, Angle stop, for variable angle adjustment up to 90° on both sides, With gauge marker for adjusting each mitre cut to scribe mark, in carton	769671
4 Planing set NS-HK 250x50	for HK 132, CSP 132, carbide pre-cutter 14 x 14 x 2.0 mm, carbide reversible blade 50 x 12 x 1.5 mm, protective cover, 1 movable guard with remote control, clamping rails, planing head dia. 250 mm, planing width 50 mm, planing depth 0-80 mm, drilling 30 mm, weight 6,8 kg, in carton	769539
5 Milling set RS-HK 160x80	for HK 132, CSP 132, milling head Ø 160 x 80 mm, 3 x carbide reversible blade 80 x 13 x 2.2 mm, carbide pre-cutter 14 x 14 x 2.0 mm, protective cover, 1 movable guard with remote control, clamping rails, planing head dia. 160 mm, planing width 80 mm, planing depth 0-38 mm, drilling 30 mm, weight 7,1 kg, in carton	769540
6 Reversible cutter blade CT-HK HW 50x12x1,5/3	for planer head NS-HK 250 x 50 and flattening head Ø 260 x 50, NS-CSP 250 x 50, HK 132, NRP 90, qty. in pack 3 piece(s), dimensions 50 x 12 x 1,5 mm, in self-service display pack	769544
Reversible cutter blade CT-HK HW 80x13x2,2/3	for notch cutter head RS-HK 160 x 80, RS-CSP 160 x 80, HK 132, CSP 132 E, qty. in pack 3 piece(s), dimensions 80 x 13 x 2,2 mm, in self-service display pack	769543
7 Pre-cutter CT-HK HW 14x14x2/6	for planer and notch cutter head, for HK 132, CSP 132, NRP 90, qty. in pack 6 piece(s), dimensions 14 x 14 x 2 mm, in self-service display pack	769542
8 Circular saw blades	from page 80	

Sawing and oscillating

System accessories

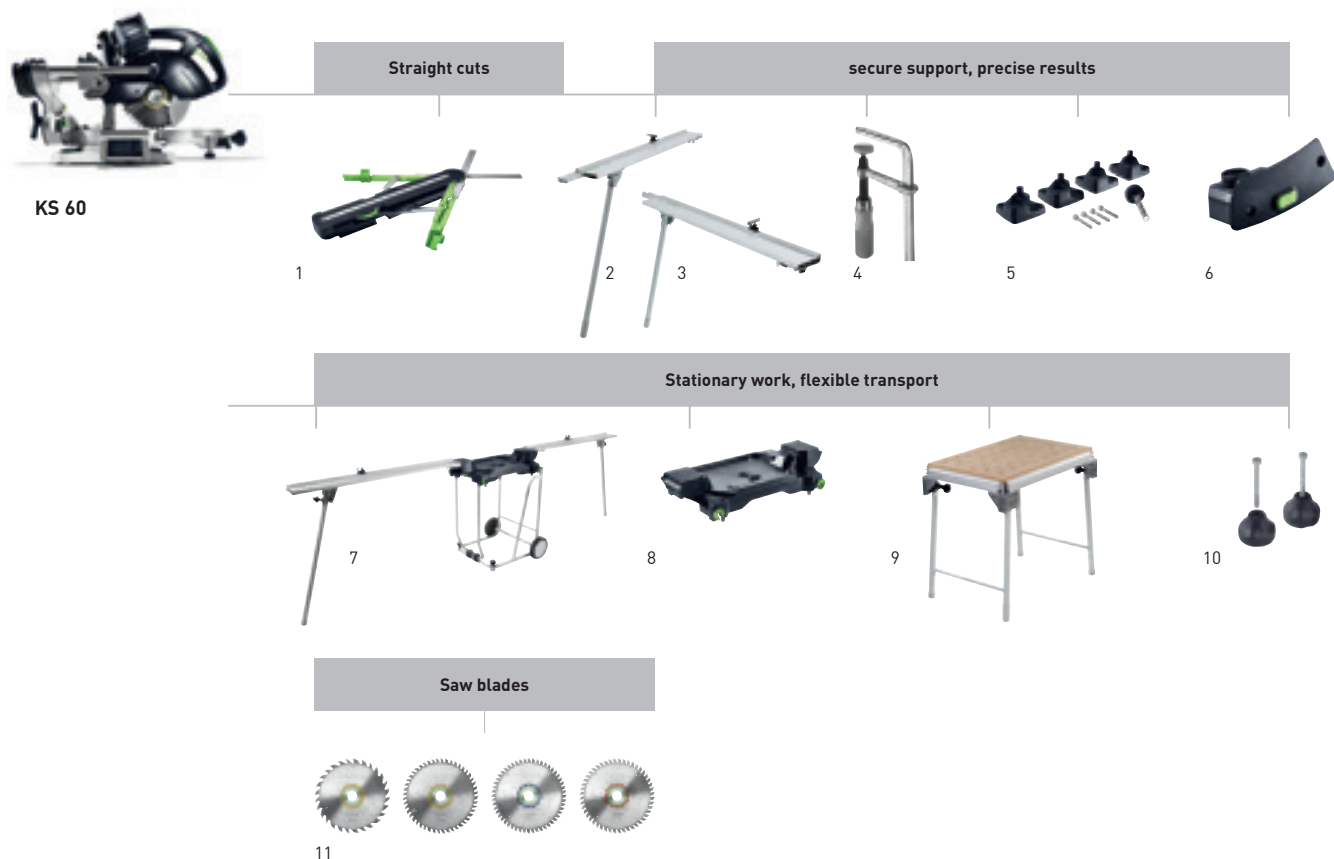

Accessories for KAPEX KS 60 sliding compound mitre saw

Denomination	Explanation	Order no.
1 Bevel SM-KS	for KS 60, KS 120, bevel for transferring angles to the circular cross-cut saw, for interior and exterior angles, dissecting angle is generated automatically, no calculations, in self-service display pack	200127
2 Trimming attachment KA-UG-KS 60-L	for KS 60, for use in conjunction with the Festool UG-KAPEX KS 60 base frame, adjustable stop, telescopic slide-out scale, fold-out pedestal and carry case, measurement scale, length of extension arm (without telescope) 1.480 mm, max. meas. length 2.400 mm, weight 4,6 kg, in carton	201907
3 Trimming attachment KA-UG-KS 60-R	for KS 60, for use in conjunction with the Festool UG-KAPEX KS 60 base frame, adjustable stop, telescopic slide-out scale, fold-out pedestal and carry case, measurement scale, length of extension arm (without telescope) 1.480 mm, max. meas. length 2.400 mm, weight 4,6 kg, in carton	201908
Trimming attachment KA-UG-KS 60-R/L	for KS 60, for use in conjunction with the Festool UG-KAPEX KS 60 base frame, consisting of KA-UG-L and KA-UG-R, adjustable stop, telescopic slide-out scale, fold-out pedestal and carry case, measurement scale, length of extension arm (without telescope) 1.480 mm, max. meas. length 2.400 mm, in carton	201909
4 Fastening clamp FSZ 120	for FS/2, MFT, solid steel version, clamping width 120 mm, qty. in pack 2 piece(s), in self-service display pack	489570
5 Increase A-SYS-KS 60	for KS 60, intermediate bases for elevating the KS 60 to the height of a SYSTAINER SYS 1 T-LOC and Classic, Table height = Systainer: Long workpieces can be comfortably supported on the floor while working, for retrofitting the KS 60, items already included with the KS 60 set variants, in carton	500121
6 Spot lighting SL-KS 60	for KS 60, LED spot lighting for precisely highlighting the cutting line and optimal visibility of the scribe mark, for retrofitting the KS 60, items already included with the KS 60 set variants, in self-service display pack	500120
7 Underframe UG-KA-KS 60 Set	for KS 60, simple folding in for transport, (KA-UG-R and KA-UG-L trimming attachments incl. in the contents), work height 900 mm, weight 21 kg, in carton	202055
Underframe UG-KS 60	for KS 60, simple folding in for transport, work height 900 mm, weight 13 kg, in carton	200129
8 Adapter plate UG-AD-KS 60	for KS 60, adapter plate and saw blade holder for attaching the KS 60 to the UG-KAPEX KS 60 base frame, in carton	202056
9 Multifunction table MFT KAPEX	used as a base frame for the KAPEX, clamping kit SZ-KS required for fixing, table with perforated top and foldaway legs, table dimensions 869 x 581 mm, work height/with foldaway legs 180 mm, working height with legs 790 mm, load capacity 120 kg, weight 19 kg, in carton	495465
10 Clamping kit SZ-KS	for KS 60, KS 88, KS 120, for tightening the KS on the multifunction table, in self-service display pack	494693
11 Circular saw blades	from page 80	

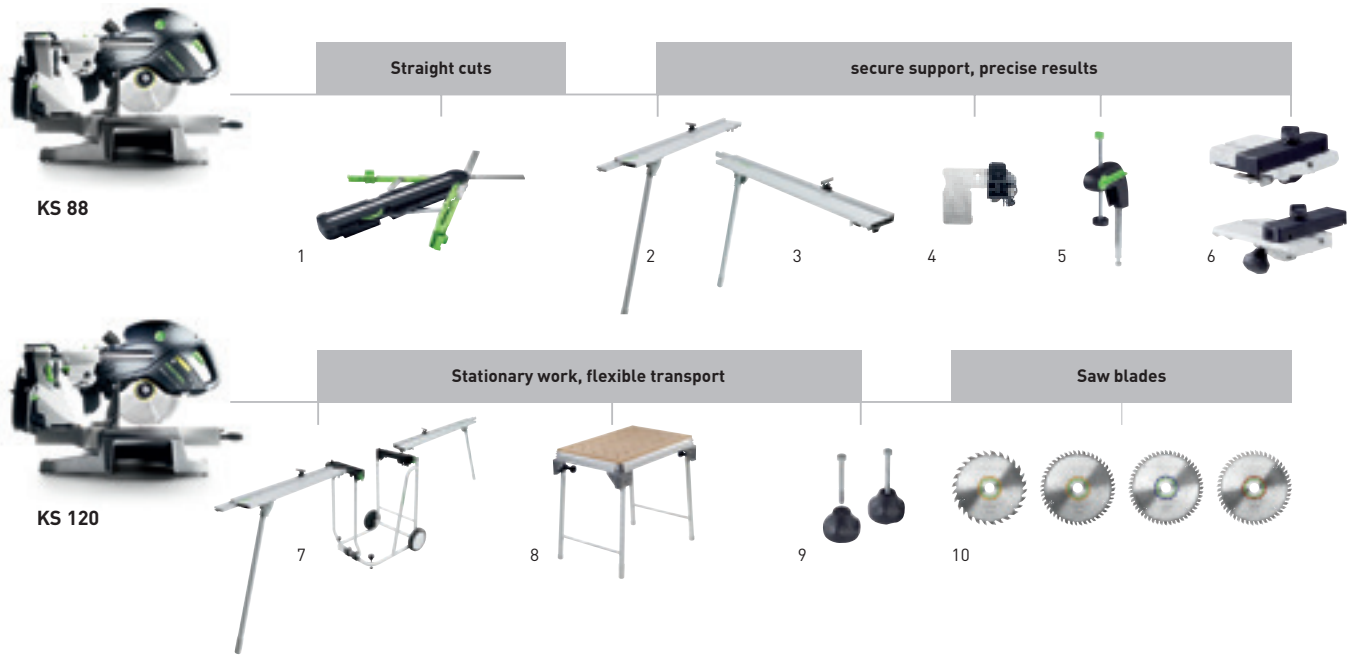

Accessories for sliding compound mitre saws KAPEX KS 88, KS 120

Denomination	Explanation	Order no.
1 Bevel SM-KS	for KS 60, KS 120, bevel for transferring angles to the circular cross-cut saw, for interior and exterior angles, dissecting angle is generated automatically, no calculations, in self-service display pack	200127
2 Trimming attachment KA-UG-KS 120-L	for KS 120, KS 88, for use in conjunction with the Festool UG-KAPEX KS 120 base frame, measurement scale, adjustable stop, telescopic slide-out scale, fold-out pedestal and carry case, length of extension arm (without telescope) 1.480 mm, max. meas. length 2.400 mm, weight 4,6 kg, in carton	497353
Trimming attachment KA-KS 120-L	for KS 120, KS 88, simple extraction and rolling out of measuring tape thanks to telescopic mechanism, only compatible with crown stop AB-KS, for use in conjunction with a Festool multifunction table (MFT) or a work table with a table height of 790 mm, adjustable stop, trimming stop, measurement scale, adjustable legs, total length 1.280 – 2.070 mm, cutting length 380 – 2.300 mm, in carton	495969
3 Trimming attachment KA-UG-KS 120-R	for KS 120, KS 88, for use in conjunction with the Festool UG-KAPEX KS 120 base frame, measurement scale, adjustable stop, telescopic slide-out scale, fold-out pedestal and carry case, length of extension arm (without telescope) 1.480 mm, max. meas. length 2.400 mm, weight 4,6 kg, in carton	497352
Trimming attachment KA-KS 120-R	for KS 120, KS 88, simple extraction and rolling out of measuring tape thanks to telescopic mechanism, only compatible with crown stop AB-KS, for use in conjunction with a Festool multifunction table (MFT) or a work table with a table height of 790 mm, adjustable stop, measurement scale, adjustable legs, trimming stop, total length 1.280 – 2.070 mm, cutting length 380 – 2.300 mm, in carton	495968
Trimming attachment KA-UG-KS 120-R/L	for KS 120, KS 88, consisting of KA-UG-L and KA-UG-R, for use in conjunction with the Festool UG-KAPEX KS 120 base frame, measurement scale, adjustable stop, telescopic slide-out scale, fold-out pedestal and carry case, length of extension arm (without telescope) 1.480 mm, max. meas. length 2.400 mm, in carton	497514
4 Adjustable stop KA-AR	for CS 50, CS 70, for positioning workpieces on trimming attachment CS 70 KA, Basis KA 100/200 and KA-KS L/R, in self-service display pack	488560
5 Terminal KL-KS 120	for KS 120, KS 88, can be used on the left or right, workpiece clamp for securing workpieces, included in the contents of the KS 120, maximum height of workpiece 120 mm, in self-service display pack	494391
6 Crown stop AB-KS 120	for KS 120, KS 88, stop for positioning crown mouldings at an angle, also used for securing the table extension KA-KS, only compatible with KA-KS, crown moulding stop with table widener, in self-service display pack	494369
7 Underframe UG-KA-KS 120-Set	for KS 120, KS 88, simple folding in for transport, (KA-UG-R and KA-UG-L trimming attachments incl. in the contents), transport rollers, Trimming attachment KA-UG-KS 120-R, Trimming attachment KA-UG-KS 120-L, work height 900 mm, weight 21 kg, in carton	497354
Underframe UG-KAPEX KS 120	for KS 120, KS 88, simple folding in for transport, transport rollers, work height 900 mm, weight 10,1 kg, in carton	497351
8 Multifunction table MFT KAPEX	used as a base frame for the KAPEX, clamping kit SZ-KS required for fixing, table with perforated top and foldaway legs, table dimensions 869 x 581 mm, work height/with foldaway legs 180 mm, working height with legs 790 mm, load capacity 120 kg, weight 19 kg, in carton	495465
9 Clamping kit SZ-KS	for KS 60, KS 88, KS 120, for tightening the KS on the multifunction table, in self-service display pack	494693
10 Circular saw blades	from page 80	

Sawing and oscillating

System accessories

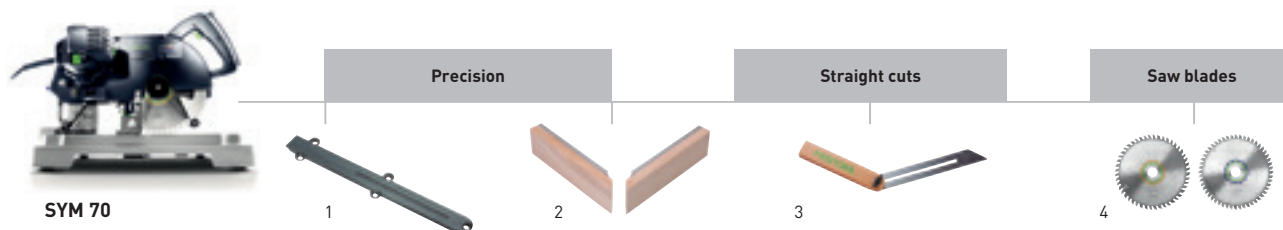

Accessories for SYMMETRIC compound mitre saw SYM 70

Denomination	Explanation	Order no.
1 Table top insert TE-SYM 70	for SYMMETRIC 70 E, qty. in pack 3 piece(s), in self-service display pack	491054
2 Additional stop ZA-SYM 70 E	for SYMMETRIC 70 E, for cutting undercut strips, qty. in pack 2 piece(s), in carton	491886
3 Precision adjustable square SM-SYM 70	for SYMMETRIC 70 E, in self-service display pack	491053
4 Circular saw blades	from page 80	

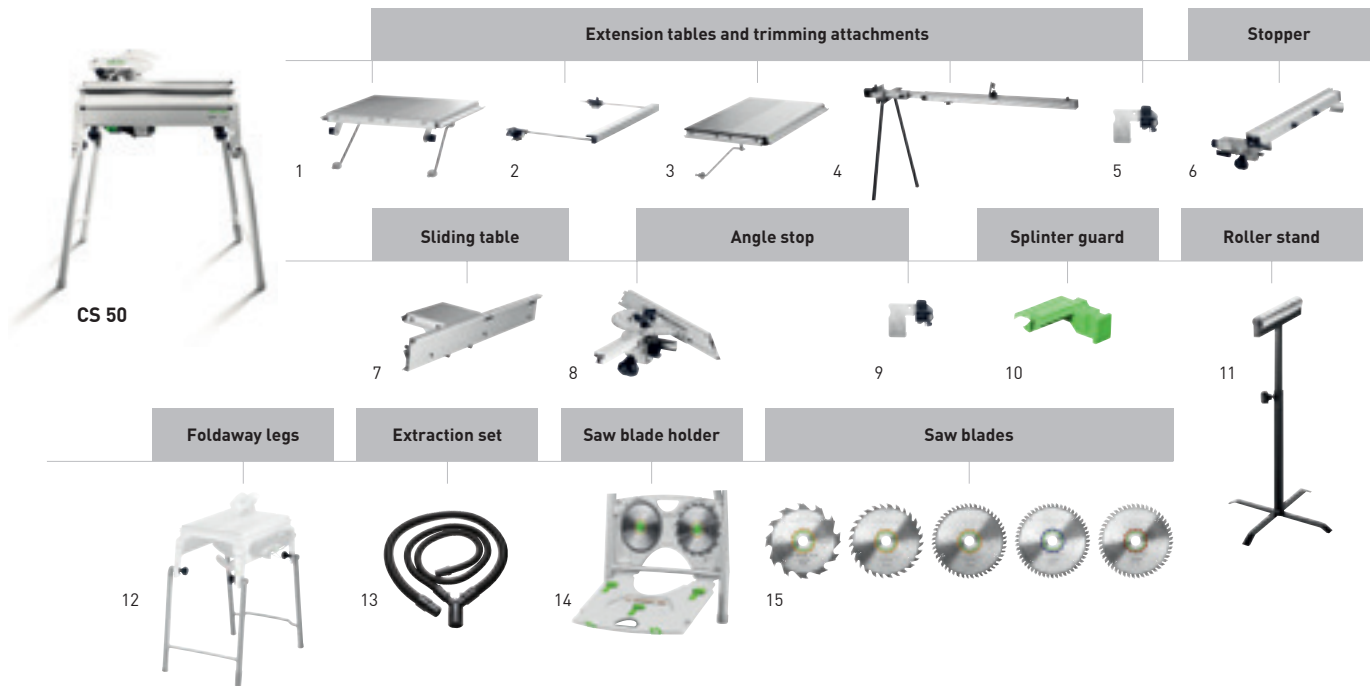

Accessories for CS 50 trimming saw

Denomination	Explanation	Order no.
1 Extension table VL	for CS 50, CMS-GE, simple fitting, folds away, for safe support of long workpieces when sawing to width, enlarges the support surface by 405 mm, dimensions 375 x 454 mm, dimensions length x width 375 x 454 mm, in carton	492092
2 Support AF	for CS 50, CMS-GE, support for both side use, supports workpieces while cutting, enlarges the support surface by 300 mm, dimensions length x width 662 x 390 mm, in carton	492242
3 Extension table VB	for CS 50, with adjustable dimension scale, extends the support area by 410 mm, max. working width longitudinal 610 mm, dimensions length x width 664 x 438 mm, in carton	492090
Extension table VB-CMS/CS 50	for CS 50, CMS-GE, dummy plate, foldaway legs, dimensions length x width 664 x 480 mm, in carton	495531
4 Trimming attachment CS 70 KA	for CS 70 and CS 50, removable, with support, bearing surface, tape measure and adjustable stop, simple extraction and rolling out of measuring tape thanks to telescopic mechanism, length 1.200 – 2.050 mm, in carton	488063
5 Adjustable stop KA-AR	for CS 50, CS 70, for positioning workpieces on trimming attachment CS 70 KA, Basis KA 100/200 and KA-KS L/R, in self-service display pack	488560
6 Stopper LA-CS 50/CMS	for CS 50, CMS-GE, with fine adjustment and rear clamp, can be operated from front, with moveable stop profile for precise and safe longitudinal cuts, in carton	492095
7 Sliding table ST	for CS 50, CMS-GE, max. working width for trimming cuts 830 mm, in carton	492100
8 Angle stop WA	for CS 70, CS 50, CMS-GE, for work requiring 2 stops, in carton	488451
9 Adjustable stop WA-AR	for CS 50, CS 70, to stop workpieces on trimming attachment CS 70 WA, CS 50 WA and Basis WRA 500, in self-service display pack	491712
10 Splinter guard CS 50 SP/10	for CS 50, for splinter-free cut edges on both sides, qty. in pack 10 piece(s), in self-service display pack	492241
11 Roller stand RB	for all semi-stationary devices (CS/KS/CMS), may be used with the CS 50, CS 70, CB 120, Basis Plus System, CMS-GE, multifunction table, to use longer workpieces for longitudinal sections and cross sections and cutting and grinding work, height adjustable 630 – 1.000 mm, in carton	488711
12 Foldaway legs CS 50 KB	for CS 50, makes two work heights possible, foldaway legs for the extension of the CS 50 floor version, in carton	492245
13 Dust extraction set CS 70 AB	for CT/CTM, comprising: dust extraction hose D27x2.0 m, dust extraction hose D36x1.0 m, Y terminal, can be used with Basis, CS 70, CS 50 and CMS, dust extraction with MINI/MIDI only possible in combination with adapter hose 499196, diameter 27 /36 mm, in carton	488292
14 Saw blade holder SGA	for CS 50, CMS-GE, for safe and space-saving storage of up to 4 saw blades (max. Ø 190 mm) and up to 3 splinterguards (not included in contents), in carton	492228
15 Circular saw blades	from page 80	

Sawing and oscillating

System accessories

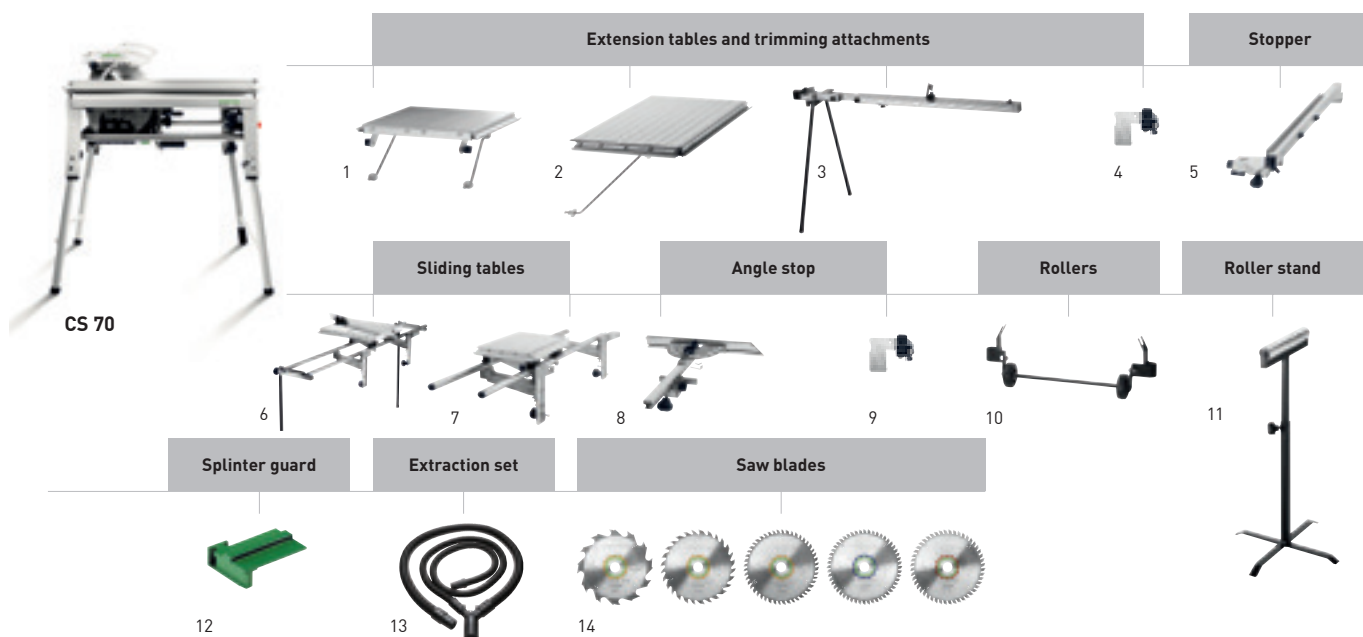

Accessories for CS 70 trimming saw

Denomination	Explanation	Order no.
1 Extension table CS 70 VL	for CS 70, simple fitting, folds away, for safe support of long workpieces when sawing to width, extends the support area by 580 mm, dimensions length x width 525 x 522 mm, in carton	488061
2 Extension table CS 70 VB	for CS 70, with adjustable dimension scale, easy and quick to assemble and dismantle, for safe and precise width sawing, extends the support area by 411 mm, max. working width longitudinal 680 mm, dimensions length x width 773 x 435 mm, in carton	488060
3 Trimming attachment CS 70 KA	for CS 70 and CS 50, removable, with support, bearing surface, tape measure and adjustable stop, simple extraction and rolling out of measuring tape thanks to telescopic mechanism, length 1.200 – 2.050 mm, in carton	488063
4 Adjustable stop KA-AR	for CS 50, CS 70, for positioning workpieces on trimming attachment CS 70 KA, Basis KA 100/200 and KA-KS L/R, in self-service display pack	488560
5 Stopper CS 70 LA	for CS 70, MFT/3-VL, with fine adjustment and rear clamp, can be operated from front, with moveable stop profile for precise and safe longitudinal cuts, in carton	488062
6 Sliding table CS 70 ST	for CS 70, for sawing boards, easy and quick to assemble and dismantle, 2 x supporting legs, stop ruler with additional clamp, max. working width for trimming cuts 920 mm, in carton	488059
7 Sliding table CS 70 ST 650	for CS 70, easy and quick to assemble and dismantle, max. working width for trimming cuts 650 mm, in carton	490312
8 Angle stop WA	for CS 70, CS 50, CMS-GE, for work requiring 2 stops, in carton	488451
9 Adjustable stop WA-AR	for CS 50, CS 70, to stop workpieces on trimming attachment CS 70 WA, CS 50 WA and Basis WRA 500, in self-service display pack	491712
10 Transport rollers CS 70 TR	for CS 70, can be fitted to foldaway legs, for simple and comfortable transportation, in carton	488064
11 Roller stand RB	for all semi-stationary devices (CS/KS/CMS), may be used with the CS 50, CS 70, CB 120, Basis Plus System, CMS-GE, multifunction table, to use longer workpieces for longitudinal sections and cross sections and cutting and grinding work, height adjustable 630 – 1.000 mm, in carton	488711
12 Splinter guard CS 70 SP /10	for CS 70, for splinter-free cut edges on both sides, qty. in pack 10 piece(s), in self-service display pack	490340
13 Dust extraction set CS 70 AB	for CT/CTM, comprising: dust extraction hose D27x2.0 m, dust extraction hose D36x1.0 m, Y terminal, can be used with Basis, CS 70, CS 50 and CMS, dust extraction with MINI/MIDI only possible in combination with adapter hose 499196, diameter 27 /36 mm, in carton	488292
14 Circular saw blades	from page 80	



SSU 200



IS 330

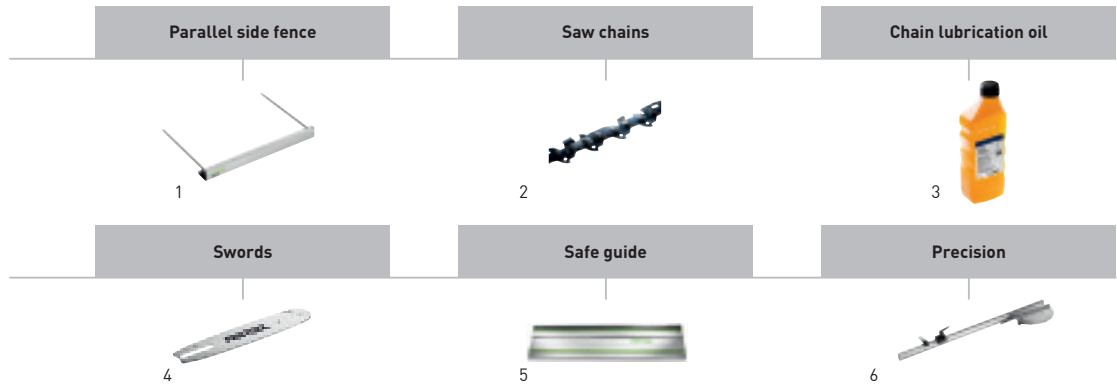

Accessories for sword saws SSU 200, IS 330

Denomination	Explanation	Order no.
1 Parallel side fence PA-SSU 200	for SSU 200, IS 330, SSP 200, ISP 330, parallel guide, guided on both sides, in carton	769098
Parallel side fence PA-A SSU 200	for SSU 200, IS 330, SSP 200, ISP 330, bilateral offset parallel stop, in carton	769099
2 Chainsaw chain SC 3/8"-91 U-39E	for SSU 200, SSP 200, chain pitch 3/8", saw chain Uni, for rip and cross cuts, in self-service display pack	769101
Chainsaw chain SC 3/8"-91 L-39E	for SSU 200, SSP 200, chain pitch 3/8", saw chain, longitudinal cuts, for rip cuts, in self-service display pack	769103
Chainsaw chain SC 3/8"-91 F-39E	for SSU 200, SSP 200, chain pitch 3/8", saw chain fine, for fine and cross cuts, in self-service display pack	769102
Chainsaw chain SC 3/8"-90 I-39E	for SSU 200, SSP 200, saw chain ISO, chain pitch 3/8", for flexible to pressure-resistant insulating materials, in self-service display pack	769100
Chainsaw chain SC 3/8"-90 I-57E	for IS 330, ISP 330, saw chain ISO, chain pitch 3/8", for flexible to pressure-resistant insulating materials, in self-service display pack	769088
Chainsaw chain SC 3/8"-91 IH-57E	for IS 330, ISP 330, for extremely pressure-resistant insulating materials, chain pitch 3/8", saw chain ISO Hard, in self-service display pack	769090
3 Chain lubrication oil CO 1 L	for SSU 200, IS 330, SSP 200, ISP 330, CCP 380, volume 1 litre, in plastic bottle	769038
4 Blade GB 10"-SSU 200	for SSU 200, SSP 200, in self-service display pack	769066
Blade GB 13"-IS 330	for IS 330, ISP 330, in self-service display pack	769089
5 Guide-rails	see the "Organising your workplace" chapter from page 400	
6 angle stop	see the "Organising your workplace" chapter from page 418	

Sawing and oscillating

Saw blades

Quality cuts better. Festool saw blades.

Durability and precision under the toughest conditions. Adapted to the application and material. Jigsaw blades manufactured from temperature-resistant, hard-wearing HS bimetal. Circular saw blades made from steel manufactured using laser technology and saw teeth made from fine-grain carbide. After all, you can only achieve a perfect cut when the saw blade is as good as the machine.

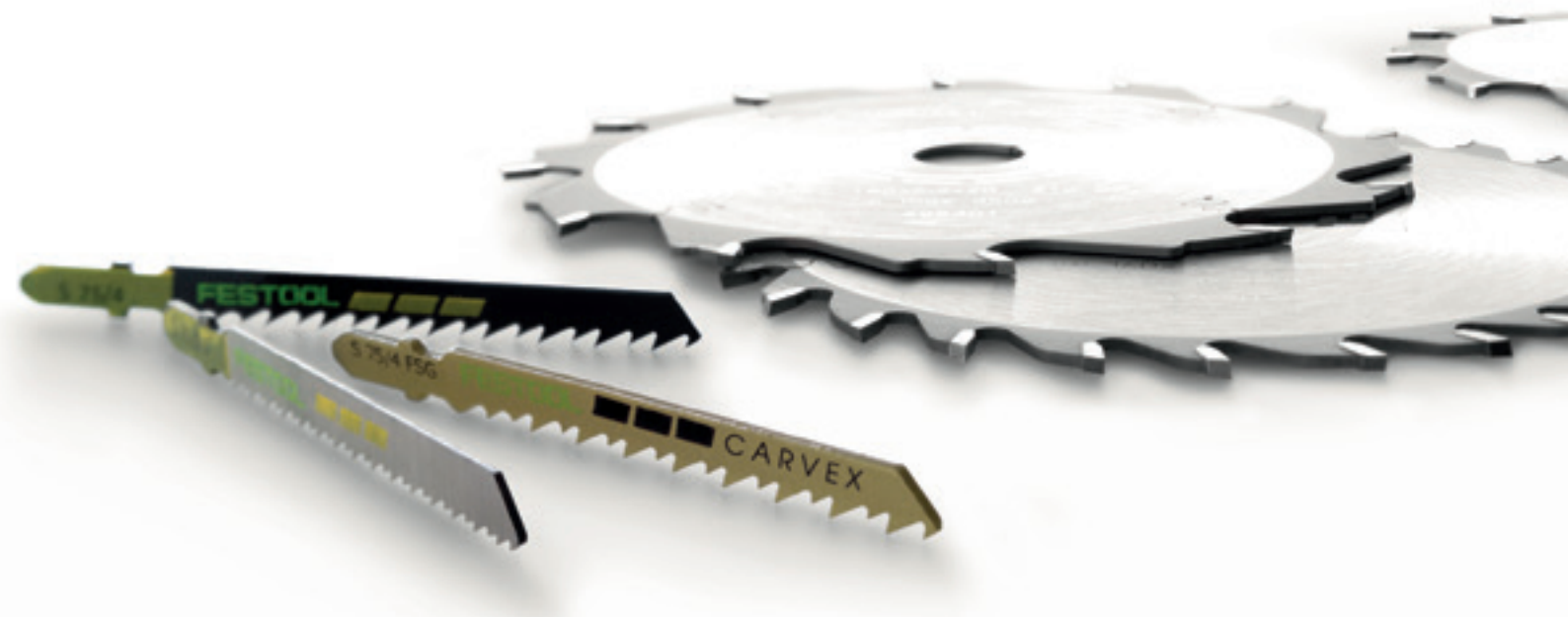

Colour code



Wood/Soft plastics

Circular saw and jigsaw blades perfectly adapted to hardwood, softwood, solid wood and building panels are available.



Plastics/Mineral materials

The fine-grain carbide used in saw blades guarantees perfect cuts in coated panels and mineral materials. Jigsaw blades made from bimetal are ideal for plastics, acrylic glass and composite materials.



Aluminium

Blue circular saw and jigsaw blades were designed for aluminium profiles and plates.



Steel/Sandwich panels

The slightly chamfered teeth of the circular saw blades are suitable for sawing cable ducts or steel sheets and profiles.



Building materials

The material and teeth of circular saw blades are designed specifically for working with abrasive materials. Insulating materials can also be machined using jigsaw blades.

Perfect adaptation

The saw blades for circular saws and jigsaws are manufactured from high-quality metal for perfect cuts and a long service life. Cutting angle and tooth shapes are adapted to the application and machine.

Long-term precision

Diamond wheels lend the teeth of the circular saw blades a perfect finish, guaranteeing a long useful life and excellent cutting results without leaving you with extensive rework.

Simple selection

The practical colour coding system helps you quickly locate the correct circular saw blade or jigsaw blade for the respective application.

Minimum heat generation

Slow heating of the circular saw blades through laser-cut and thermally adjusted blade cores.

Rapid cutting progress

High-quality steel and optimised expansion slots of the circular saw blades for a smooth, safe cutting progress.

Robust quality

Long service life and excellent sharpening properties of saw teeth of the circular saw blades guarantee an excellent price/performance ratio.

Tooth shapes**Alternate top bevel saw blade**

The teeth on this blade slope to the left and right and cut alternately. The alternate top bevel saw blade is a universal blade for all types of wood.

**Triple chip grind saw blade**

With alternating trapezoidal and flat teeth, this blade is used for cutting aluminium, hard plastic and materials with hard coatings.

**Flat tooth saw blade**

The edges of the teeth are straight, not slanted. Each tooth cuts in the same way. This tooth shape is used in saws for cutting steel and construction materials.

W/PW

TF

F

Sawing and oscillating

Saw blades

Tooth pitch, type and material



cross-set teeth for quick cuts



conically ground blades for clean cuts



HCS tool steel: standard quality for all types of wood



HS bimetal: resistant to high temperatures and hard-wearing

Saw blade features



carbide: resistant to high temperatures and hard-wearing



brazed carbide grit, fine



coarse or fine saw blade. Rule of thumb: at least 3 teeth should be engaged



serrated blade, milled teeth

Universal saw blade		Length of cutting blade	Pitch	Max. workpiece thickness	Qty. in pack	Order no.
	S 75/4/5	75 mm	4 mm		5 piece(s)	486546
	S 75/4/25	75 mm	4 mm		25 piece(s)	486962
	S 75/4/100	75 mm	4 mm		100 piece(s)	493522
	S 105/4/5	105 mm	4 mm		5 piece(s)	486547
Fine-cut saw blade						
	S 75/2,5/5	75 mm	2,5 mm		5 piece(s)	486548
	S 75/2,5/25	75 mm	2,5 mm		25 piece(s)	486963
	S 75/2,5/100	75 mm	2,5 mm		100 piece(s)	493521
	HS 75/2,5 BI/5	75 mm	2,5 mm		5 piece(s)	490178
	HS 75/2,5 BI R/5	75 mm	2,5 mm		5 piece(s)	493570
Special wood saw blade						
	S 75/4 FS/5	75 mm	4 mm		5 piece(s)	486549
	S 75/4 FS/20	75 mm	4 mm		20 piece(s)	490256
	S 75/4 FS/100	75 mm	4 mm		100 piece(s)	493523
	S 75/4 FSG 5X	75 mm	4 mm		5 piece(s)	499476
	S 75/4 FSG 20X	75 mm	4 mm		20 piece(s)	499441
	S 105/4 FSG 5X	105 mm	4 mm		5 piece(s)	499477
	S 105/4 FSG 20X	105 mm	4 mm		20 piece(s)	499475
	S 145/4 FSG 5X	145 mm	4 mm		5 piece(s)	499478



Softwood, hardwood	Untreated chipboard	Coated chipboard, veneered blockboard	Soft plastics	Acrylic glass
--------------------	---------------------	---------------------------------------	---------------	---------------

	<input checked="" type="radio"/>	<input checked="" type="radio"/>	<input checked="" type="radio"/>		
	<input checked="" type="radio"/>	<input checked="" type="radio"/>	<input checked="" type="radio"/>		
	<input checked="" type="radio"/>	<input checked="" type="radio"/>	<input checked="" type="radio"/>		
	<input checked="" type="radio"/>	<input checked="" type="radio"/>	<input checked="" type="radio"/>		

	<input checked="" type="radio"/>		<input checked="" type="radio"/>	<input checked="" type="radio"/>	<input checked="" type="radio"/>
	<input checked="" type="radio"/>		<input checked="" type="radio"/>	<input checked="" type="radio"/>	<input checked="" type="radio"/>
	<input checked="" type="radio"/>		<input checked="" type="radio"/>	<input checked="" type="radio"/>	<input checked="" type="radio"/>
	<input checked="" type="radio"/>		<input checked="" type="radio"/>	<input checked="" type="radio"/>	<input checked="" type="radio"/>
	<input checked="" type="radio"/>		<input checked="" type="radio"/>	<input checked="" type="radio"/>	<input checked="" type="radio"/>

	<input checked="" type="radio"/>	<input checked="" type="radio"/>	<input checked="" type="radio"/>		
	<input checked="" type="radio"/>	<input checked="" type="radio"/>	<input checked="" type="radio"/>		
	<input checked="" type="radio"/>	<input checked="" type="radio"/>	<input checked="" type="radio"/>		
	<input checked="" type="radio"/>	<input checked="" type="radio"/>	<input checked="" type="radio"/>		
	<input checked="" type="radio"/>	<input checked="" type="radio"/>	<input checked="" type="radio"/>		
	<input checked="" type="radio"/>	<input checked="" type="radio"/>	<input checked="" type="radio"/>		
	<input checked="" type="radio"/>	<input checked="" type="radio"/>	<input checked="" type="radio"/>		
	<input checked="" type="radio"/>	<input checked="" type="radio"/>	<input checked="" type="radio"/>		

Extremely appropriate Appropriate

Sawing and oscillating

Saw blades

Tooth pitch, type and material



cross-set teeth for quick cuts



conically ground blades for clean cuts



HCS tool steel: standard quality for all types of wood



HS bimetal: resistant to high temperatures and hard-wearing

Saw blade features



carbide: resistant to high temperatures and hard-wearing



brazed carbide grit, fine



coarse or fine saw blade. Rule of thumb: at least 3 teeth should be engaged

















serrated blade, milled teeth

Curve saw blade		Length of cutting blade	Pitch		Max. workpiece thickness	Qty. in pack	Order no.
	S 75/4 K/5	75 mm	4 mm		55 mm	5 piece(s)	486563
	S 75/4 K/25	75 mm	4 mm		55 mm	25 piece(s)	486965
	HS 75/3 BI-FC/5	75 mm	3 mm		30 mm	5 piece(s)	496395
	S 50/1,4 K/5	50 mm	1,4 mm		30 mm	5 piece(s)	486564
	HS 75/4 BI/5	75 mm	4 mm		55 mm	5 piece(s)	486553
Plastic saw blade							
	HS 75/3 BI/5	75 mm	3 mm		55 mm	5 piece(s)	486554
Metal saw blade							
	HS 60/1,2 BI/5	60 mm	1,2 mm		30 mm	5 piece(s)	486556
	HS 60/1,2 BI/25	60 mm	1,2 mm		30 mm	25 piece(s)	488016
	HS 60/1,4 BI VA/5	60 mm	1,4 mm		10 mm	5 piece(s)	490181
	HS 105/1,2 BI/5	105 mm	1,2 mm		85 mm	5 piece(s)	486558
	HS 155/1,2 BI/5	155 mm	1,2 mm		130 mm	5 piece(s)	490180
	HS 60/2 BI/5	60 mm	2 mm		30 mm	5 piece(s)	486557
	HS 105/2 BI/5	105 mm	2 mm		85 mm	5 piece(s)	486559
Special saw blade							
	HM 75/4,5	75 mm	4,5 mm		50 mm	1 piece(s)	486561
	HM 105/4,5	105 mm	4,5 mm		80 mm	1 piece(s)	486560
	R 54 G Riff	54 mm	- mm		30 mm	1 piece(s)	486562
Insulating material saw blade							
	S 155/W/3	155 mm			130 mm	3 piece(s)	493656

Sawing and oscillating

Saw blades

02

														
Softwood, hardwood	Untreated chipboard	Coated chipboard, veneered blockboard	Laminated boards	Reinforced/fibre-reinforced plastics	Soft plastics	Acrylic glass	Composite materials	Non-ferrous metals	Aluminium, steel sheets and profiles	Sandwich material / boards	Stainless steel	Iron, steel	Glass, tiles, ceramics	Polystyrene, cardboard, insulating materials

<input checked="" type="radio"/>	<input checked="" type="radio"/>	<input checked="" type="radio"/>												
<input checked="" type="radio"/>	<input checked="" type="radio"/>	<input checked="" type="radio"/>												
<input checked="" type="radio"/>		<input checked="" type="radio"/>												
<input checked="" type="radio"/>	<input checked="" type="radio"/>	<input checked="" type="radio"/>												
<input checked="" type="radio"/>	<input checked="" type="radio"/>	<input checked="" type="radio"/>	<input checked="" type="radio"/>											

					<input checked="" type="radio"/>	<input checked="" type="radio"/>	<input checked="" type="radio"/>							
--	--	--	--	--	----------------------------------	----------------------------------	----------------------------------	--	--	--	--	--	--	--

								<input checked="" type="radio"/>	<input checked="" type="radio"/>					
								<input checked="" type="radio"/>	<input checked="" type="radio"/>					
								<input checked="" type="radio"/>	<input checked="" type="radio"/>					
											<input checked="" type="radio"/>			
								<input checked="" type="radio"/>	<input checked="" type="radio"/>	<input checked="" type="radio"/>				
										<input checked="" type="radio"/>				
								<input checked="" type="radio"/>	<input checked="" type="radio"/>		<input checked="" type="radio"/>	<input checked="" type="radio"/>		











		<input checked="" type="radio"/>		<input checked="" type="radio"/>	<input checked="" type="radio"/>			<input checked="" type="radio"/>					<input checked="" type="radio"/>	
		<input checked="" type="radio"/>		<input checked="" type="radio"/>	<input checked="" type="radio"/>			<input checked="" type="radio"/>						
				<input checked="" type="radio"/>				<input checked="" type="radio"/>				<input checked="" type="radio"/>	<input checked="" type="radio"/>	

														<input checked="" type="radio"/>
--	--	--	--	--	--	--	--	--	--	--	--	--	--	----------------------------------

Extremely appropriate Appropriate

Sawing and oscillating

Saw blades

Colour code	Material	Recommended speed range
		 3-6
		K 3-5
		Fe 2-4
		Al 3-6
		4-6

Standard saw blade

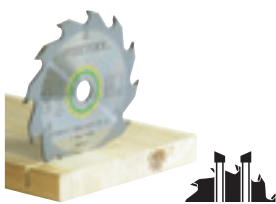

	Diameter	Cutting width	Hole Ø	No. of teeth	Chip angle	Tooth shape	Order no.
160x1,8x20 W18	160 mm	1,8 mm	20 mm	18	25°	W	500458
160x2,2x20 W18	160 mm	2,2 mm	20 mm	18	25°	W	768129
210x2,6x30 W18	210 mm	2,6 mm	30 mm	18	20°	W	493197
230x2,5x30 W24	230 mm	2,5 mm	30 mm	24	20°	W	500647
350x3,5x30 W24	350 mm	3,5 mm	30 mm	24	10°	W	769667

Panther saw blade

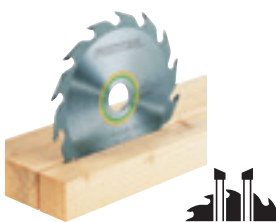

160x1,8x20 PW12	160 mm	1,8 mm	20 mm	12	25°	W	500460
160x2,2x20 PW12	160 mm	2,2 mm	20 mm	12	20°	PW	496301
190x2,6 FF PW16	190 mm	2,6 mm	FF *	16	28°	PW	492049
210x2,6x30 PW16	210 mm	2,6 mm	30 mm	16	28°	PW	493196
225x2,6x30 PW18	225 mm	2,6 mm	30 mm	18	28°	PW	496303
230x2,5x30 PW18	230 mm	2,5 mm	30 mm	18	28°	PW	500646

Universal saw blade

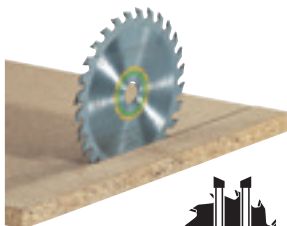

160x2,2x20 W28	160 mm	2,2 mm	20 mm	28	15°	W	496302
190x2,6 FF W32	190 mm	2,6 mm	FF *	32	10°	W	492048
210x2,4x30 W36	210 mm	2,4 mm	30 mm	36	15°	W	493198
216x2,3x30 W36	216 mm	2,3 mm	30 mm	36	-5°	W	500124
225x2,6x30 W32	225 mm	2,6 mm	30 mm	32	20°	W	488288
260x2,5x30 W60	260 mm	2,5 mm	30 mm	60	-5°	W	494604

Fine tooth saw blade

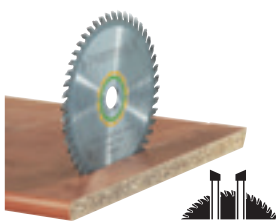

160x1,8x20 W32	160 mm	1,8 mm	20 mm	32	5°	W	500459
160x2,2x20 W48	160 mm	2,2 mm	20 mm	48	5°	W	491952
190x2,4 FF W48	190 mm	2,4 mm	FF *	48	8°	W	492050
210x2,4x30 W52	210 mm	2,4 mm	30 mm	52	5°	W	493199
216x2,3x30 W48	216 mm	2,3 mm	30 mm	48	-5°	W	491050
216x2,3x30 W60	216 mm	2,3 mm	30 mm	60	-5°	W	500125
225x2,6x30 W48	225 mm	2,6 mm	30 mm	48	10°	W	488289
230x2,5x30 W48	230 mm	2,5 mm	30 mm	48	10°	W	500648
260x2,5x30 W80	260 mm	2,5 mm	30 mm	80	-5°	W	494605

Recommended speed range

Processed material													
Coated panels, laminate panels													
Veneered panels, parquet													
Soft plastic, soft PVC													
Hard plastic, hard PVC													
Solid wood cross sections, blockboard													
Rip cuts in solid wood													
MDF and plasterboard, soft cement panels													
Plywood, multiplex/multilayered wood													
Acrylic glass													
MDF - Medium-density fibreboard													
HDF - High-density fibreboard													
Untreated chipboard													
Rockwool board													
Dry plaster material													











Suitable for machine													
TS 55 R, TSC 55, TS 55, ATF 55, AP 55													
TS 75													
HK 55, HKC 55													
HK 85													
HK 132													
PRECISIO CS 70													
PRECISIO CS 50													
SYMMETRIC SYM 70													
KAPEX KS 60													
KAPEX KS 88, KS 120													

Extremely appropriate

Appropriate

Sawing and oscillating

Saw blades

Colour code	Material	Recommended speed range
		 3-6
		K 3-5
		Fe 2-4
		Al 3-6
		4-6

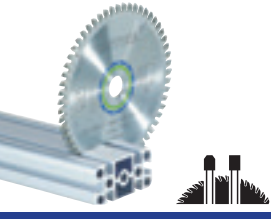
Special saw blade	Diameter	Cutting width	Hole Ø	No. of teeth	Chip angle	Tooth shape	Order no.	
	160x2,2x20 TF52	160 mm	2,2 mm	20 mm	52	-5°	TF	496306
	190x2,6 FF TF58	190 mm	2,6 mm	FF *	58	-5°	TF	492051
	210x2,4x30 TF72	210 mm	2,4 mm	30 mm	72	-5°	TF	493201
	216x2,3x30 W60	216 mm	2,3 mm	30 mm	60	-5°	W	491051
	216x2,3x30 TF64	216 mm	2,3 mm	30 mm	64	0°	TF	500122
	225x2,6x30 TF68	225 mm	2,6 mm	30 mm	68	-5°	TF	488291
	230x2,5x30 TF76	230 mm	2,5 mm	30 mm	76	-5°	TF	500649
	260x2,4x30 TF68	260 mm	2,4 mm	30 mm	68	0°	TF	494607

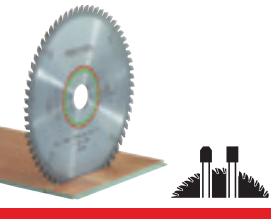
Special saw blade	Diameter	Cutting width	Hole Ø	No. of teeth	Chip angle	Tooth shape	Order no.	
	160x2,2x20 TF48	160 mm	2,2 mm	20 mm	48	4°	TF	496308
	190x2,6 FF TF54	190 mm	2,6 mm	FF *	54	4°	TF	492052
	210x2,4x30 TF60	210 mm	2,4 mm	30 mm	60	4°	TF	493200
	216x2,3x30 WZ/FA60	216 mm	2,3 mm	30 mm	60	-5°	WZ/FA	500123
	225x2,6x30 TF64	225 mm	2,6 mm	30 mm	64	4°	TF	489459
	260x2,5x30 WZ/FA64	260 mm	2,5 mm	30 mm	64	-5°	WZ/FA	494606

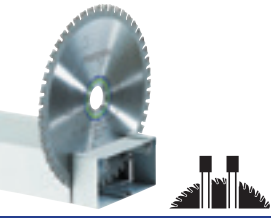
Flat tooth saw blade	Diameter	Cutting width	Hole Ø	No. of teeth	Chip angle	Tooth shape	Order no.	
	210x2,2x30 F36	210 mm	2,2 mm	30 mm	36	1°	F	493351
	230x2,5x30 F48	230 mm	2,5 mm	30 mm	48	0°	F	500651
	350x2,9x30 TF60	350 mm	2,9 mm	30 mm	60	0°	TF	769668

Diamond saw blade	Diameter	Cutting width	Hole Ø	No. of teeth	Chip angle	Tooth shape	Order no.	
	160x2,2x20 DIA4	160 mm	2,2 mm	20 mm	4	-5°	F	201910
Accessories only for TS 55 R and TSC 55								

Recommended speed range

Sawing and oscillating

System accessories



Accessories for oscillator VECTURO OS 400

Denomination	Explanation	Order no.
1 Depth stop set OS-TA Set	for OS 400, enables plunge cuts with a defined depth, adapter for mounting positioning aid and depth stop without tools, max. plunge depth, depth stop 56 mm, max. plunge depth, sliding shoe 20 mm, notch scale on depth adjuster 1,5 mm, weight 0,1 kg, in self-service display pack	500160
2 Positioning aid set OS-AH Set	for OS 400, enables precision positioning and sawing along a scribe mark, adapter for mounting positioning aid and depth stop without tools, max. plunge depth with position guide 60 mm, weight 0,3 kg, in self-service display pack	500161
3 Positioning aid/depth stop set OS-TA/AH Set	for OS 400, enables precision positioning and sawing along a scribe mark as well as plunge cuts to a defined depth, positioning aid, depth stop, max. plunge depth, depth stop 56 mm, max. plunge depth, sliding shoe 20 mm, max. plunge depth with position guide 60 mm, notch scale on depth adjuster 1,5 mm, weight 0,47 kg, in self-service display pack	500251

Sawing and oscillating

Saw blades

02

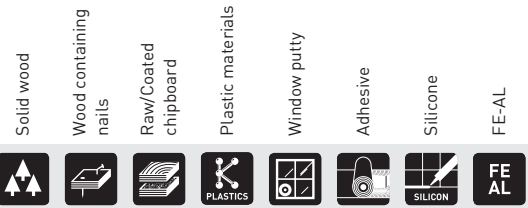

Designation	Length (mm)	Width (mm)	Model	VE order no.	Material Compatibility	
Saw blade, wood						
Two rows of original Japan teeth for high-precision cuts and clean cutting edges. Note: Plunge-cuts not possible.		50	35	HSB 50/35/J	5x 500142	Wood, Plastic materials
		50	45	HSB 50/45/J	5x 500146	Wood, Plastic materials
		50	55	HSB 50/55/J	5x 500148	Wood, Plastic materials
		50	65	HSB 50/65/J	5x 500145	Wood, Plastic materials
Saw blade, wood (HCS) – ideal in combination with the depth stop.						
For long, straight cuts and cutting out sections of laid parquet or laminate flooring.		-	-	HSB 100/HCS	1x 500139	Wood, Plastic materials
Universal bi-metal saw blade for plunge-cuts						
Accessories for interior fitting. For hardwood, softwood and all other types of wood. Also suitable for plastic and plasterboard. High cutting speed. Extremely durable and robust.		78	32	USB 78/32/Bi	5x 500143	Wood, Plastic materials, Adhesive, Silicone
		78	42	USB 78/42/Bi	5x 500147	Wood, Plastic materials, Adhesive, Silicone
		50	35	USB 50/35/Bi	5x 500144	Wood, Plastic materials, Adhesive, Silicone
		50	65	USB 50/65/Bi	5x 500149	Wood, Plastic materials, Adhesive, Silicone
Bi-metal saw blade, metal						
Ideal for machining aluminium and non-ferrous metals. With corrugated blade.		50	35	MSB 50/35/Bi	5x 500140	FE-AL
HSS saw blade, offset (HCS). Segmented for working right into corners.						
Countersunk clamping screw is perfectly flush.		-	-	SSB 100/HCS	1x 500136	Wood, Plastic materials, Adhesive, Silicone, FE-AL
Special blade						
For cutting out putty from insulating window panes, for example.		-	-	SSB 32	1x 500137	Window putty, Adhesive, Silicone
Filler						
For removing layers and coatings such as adhesive residue or silicone.		-	-	SSP 56,5/1	1x 500138	Adhesive, Silicone

■ Wood blades
 ■ Universal blades
 ■ Metal blade
 ■ Special blades for window fitters and floor layers
 ● Appropriate



FESTOOL

220

Machining surfaces

Overview of products and applications 88

Electric and cordless sanders
Gear-drive eccentric sander ROTEX RO 90 DX, RO 125, RO 150 97

Eccentric sander ETS 125 R, ETSC 125, ETS EC 125,
ETS 150, ETS EC 150 100

Orbital sander RS 100, RS 200, RS 300, RTS 400 R, RTSC 400 106

Delta sander DTS 400 R, DTSC 400 111

Linear sander DUPLEX LS 130 113

Rotary sander RAS 180 114

PLANEX long-reach sander LHS-E 225, LHS 225 115

Belt sanders BS 75, BS 105, CMS-BS 117

Compressed air sanders
Compressed air eccentric sander LEX 3 121

Compressed air RUTSCHER LRS 93, LRS 400 124

Polishers and oil dispensers
Rotary polisher SHINEX RAP 150, POLLUX 180 128

SURFIX oil dispenser OS 130

Brush machine
RUSTOFIX brush machine BMS 180 131

Accessories and consumable materials 132
 The Festool system

Machining surfaces

Overview of products and applications

NEW

NEW

NEW

Page 97

98

99

101

110

112

Whether you need to remove material quickly and efficiently or achieve a particularly fine sanding finish – your applications determine the requirements and Festool sanders provide all the answers. Simply select the right machine for your most frequently performed practical applications.

RO 90 DX

RO 125

RO 150

ETSC 125

RTSC 400

DTSC 400



Applications

Gear-drive eccentric sander ROTEX

Cordless sander

Flat surfaces

Coarse sanding
Rough sanding
Fine sanding
Extra-fine sanding



Curved surfaces

Coarse sanding
Rough sanding
Fine sanding
Extra-fine sanding



Internal corners

Coarse sanding
Rough sanding
Fine sanding
Extra-fine sanding



Polishing

Small surfaces
Large surfaces

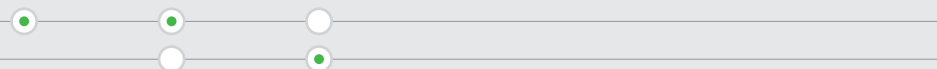

Technical data

	RO 90 DX	RO 125	RO 150	ETSC 125	RTSC 400	DTSC 400
Battery voltage (V)				18	18	18
Li-ion battery capacity (Ah)				3,1	3,1	3,1
Power consumption with mains adapter (W)	400	500	720	150	150	150
ROTEX rotary motion speed (rpm)	260 – 520	300 – 600	320 – 660			
Eccentric motion speed (rpm)	3.500 – 7.000	3.000 – 6.000	3.300 – 6.800	6.000 – 10.000	6.000 – 10.000	6.000 – 10.000
Sanding stroke (mm)	3	3,6	5	2	2	2
Sanding pad dia./StickFix sanding pad (mm)	90	125	150	125	80 x 130	100 x 150
Weight (with Li-ion*) (kg)	1,5	1,9	2,3	1,4*	1,4*	1,4*

100 — 102 — 103 — 103 — 104 — 104

ETS 125 R ETS EC 125 ETS 150/3 ETS 150/5 ETS EC 150/3 ETS EC 150/5



Eccentric sanders

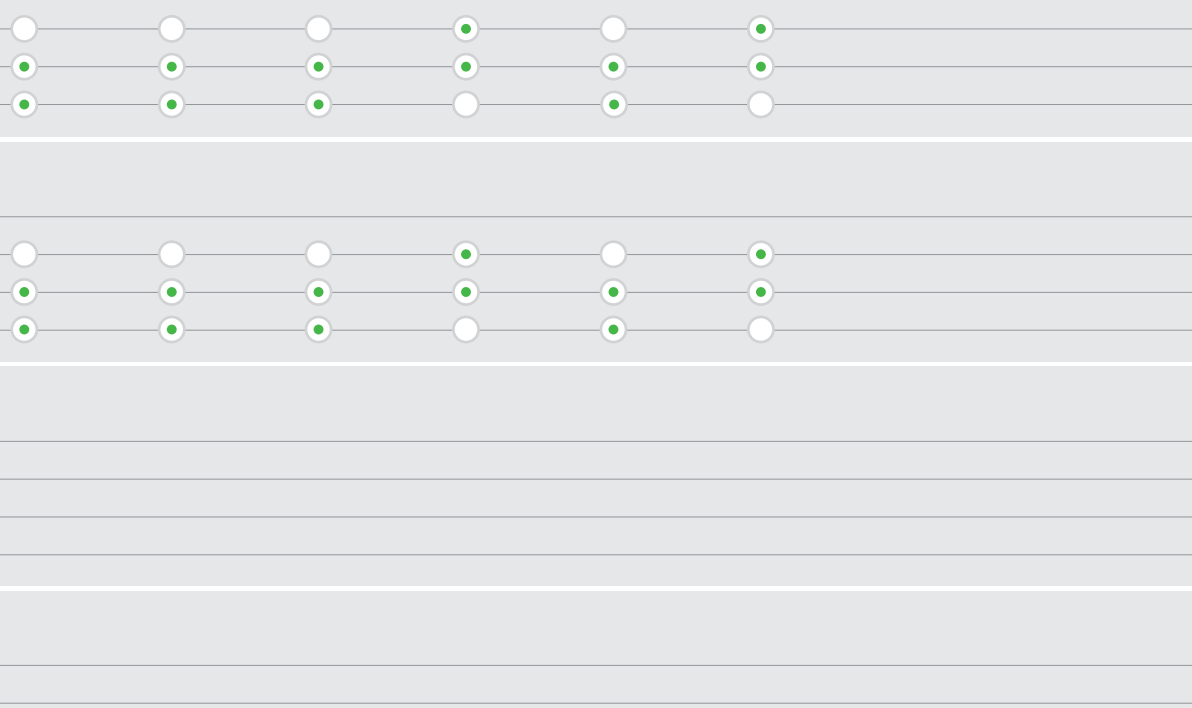

● Extremely appropriate ○ Appropriate

	250	400	310	310	400
	6.000 – 12.000	6.000 – 10.000	4.000 – 10.000	4.000 – 10.000	6.000 – 10.000
	2	3	3	5	3
	125	125	150	150	150
	1,2	1,2	1,8	1,8	1,2

Machining surfaces

Overview of products and applications

Page 106 — 106 — 107 — 108 — 109

RS 100

RS 100 C

RS 200

RS 300

RTS 400 R



Applications

Geared orbital sanders RUTSCHER

Orbital sander RUTSCHER

Flat surfaces

- Coarse sanding
- Rough sanding
- Fine sanding
- Extra-fine sanding

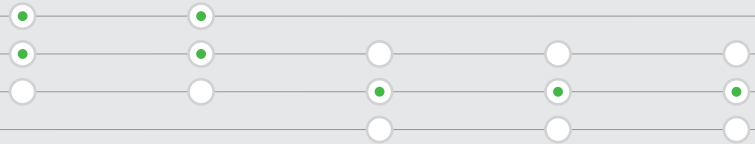

Curved surfaces

- Coarse sanding
- Rough sanding
- Fine sanding
- Extra-fine sanding



Internal corners

- Coarse sanding
- Rough sanding
- Fine sanding
- Extra-fine sanding

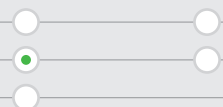

Profiles

- Coarse sanding
- Rough sanding
- Fine sanding
- Extra-fine sanding



Technical data

	RS 100	RS 100 C	RS 200	RS 300	RTS 400 R
Power consumption (W)	620	520	330	280	250
Idle engine speed (rpm)	6.000	7.000	4.000 – 10.000	4.000 – 10.000	6.000 – 12.000
Sanding stroke (mm)	5	5	2,4	2,4	2
Sanding pad (mm)	115 x 221	115 x 221	115 x 225	93 x 175	80 x 130
Weight (kg)	3,1	3,0	2,5	2,3	1,2

111 ——— 113

DTS 400 R

LS 130



Delta sander

Linear sander
DUPLEX



Extremely appropriate

Appropriate

	250	260
	6.000 – 12.000	4.000 – 6.000
	2	4
	100 x 150	133 x 80
	1,2	1,7

Machining surfaces

Overview of products and applications

NEW

Page 114 — 115 — 116

RAS 180

LHS-E 225

LHS 225



Applications

Rotary sander

PLANEX long-reach sander

Flat surfaces

- Coarse sanding
- Rough sanding
- Fine sanding
- Extra-fine sanding



Curved surfaces

- Coarse sanding
- Rough sanding
- Fine sanding
- Extra-fine sanding



Drywalling

- Sanding plasterboard and dry wall filler
- Sanding set filler
- Sanding filler on high ceilings



Texturing surfaces

Technical data

Power consumption (W)	1.500	400	550
Idle engine speed (rpm)	800 – 4.000	400 – 920	340 – 910
Sanding pad Ø (mm)	180	215	215
Belt length x belt width (mm)			
Sanding area (mm)			
Tool Ø (mm)			
Weight (Length 1.10 m) (kg)			3,8
Weight (Length 1.60 m) (kg)			4,6
Weight (kg)	4,2	4,0	

Machining surfaces

Overview of products and applications

Page 121 — 122 — 122 — 123 — 123

LEX 3 77

LEX 3 125/3

LEX 3 125/5

LEX 3 150/3

LEX 3 150/5



Applications

LEX compressed air eccentric sander

Flat surfaces

Coarse sanding
Rough sanding
Fine sanding
Extra-fine sanding



Curved surfaces

Coarse sanding
Rough sanding
Fine sanding
Extra-fine sanding



Internal corners

Coarse sanding
Rough sanding
Fine sanding
Extra-fine sanding

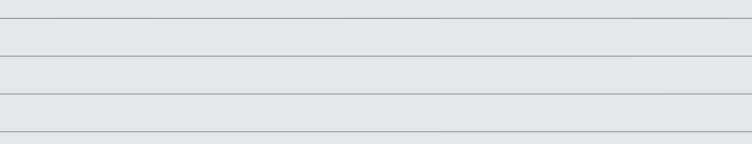

Technical data

	LEX 3 77	LEX 3 125/3	LEX 3 125/5	LEX 3 150/3	LEX 3 150/5
Operating pressure (flow pressure) (bar)	6	6	6	6	6
rpm	21.000	19.000	19.000	20.000	20.000
Eccentric motion speed (rpm)	10.500	9.500	9.500	10.000	10.000
Sanding stroke (mm)	2,5	3	5	3	5
Pad Ø (mm)	77	125	125	150	150
Sanding pad StickFix (mm)					
Air consumption at rated load (l/min)	270	290	290	290	290
Weight (kg)	0,8	1,0	1,0	1,0	1,0

123 ——— 124 ——— 125

LEX 3 150/7

LRS 93

LRS 400



LEX compressed air eccentric sander

Compressed air orbital sander



Extremely appropriate

Appropriate

	6	6	6
	20.000	14.000	14.000
	10.000		
	7	4	4
	150		
		93 x 175	80 x 400
	310	310	390
	1,0	1,5	2,1

Machining surfaces

Overview of products and applications

Page 128 — 128 — 129

SHINEX RAP 150-14

SHINEX RAP 150-21

POLLUX 180



Applications

Rotary polisher

Polishing

Small surfaces

Large surfaces



Extremely appropriate

Appropriate

Technical data

Power consumption (W)	1.200	1.200	1.500
Idle engine speed (rpm)	600 – 1.400	900 – 2.100	800 – 2.400
Maximum polishing pad diameter (mm)	150	150	180
Spindle thread	M14	M14	M14
Weight (kg)	2,1	2,1	3,6



ROTEX RO 90 DX

Round tool that also sands in corners.

- ▶ Four tools in one: for coarse sanding, fine sanding, delta sanding and polishing. Resulting in low investment costs and savings on working time
- ▶ Durable eccentric bearings, a double-sealed gear unit and a dustproof switch extend the service life of the machine
- ▶ ROTEX rotary motion for convenient polishing – the reduced speed keeps the temperature low and prevents the polish from clouding or spraying off
- ▶ FastFix sanding pad system, tool-less



Technical data

Power consumption (W)	400
ROTEX rotary motion speed (min ⁻¹)	260 – 520
Eccentric motion speed (min ⁻¹)	3.500 – 7.000
Sanding stroke (mm)	3
FastFix sanding pad dia. (mm)	90
Dust extraction connection dia. (mm)	27
Weight (kg)	1,5



■ = MMC Multi Material Control electronics

Items included	Order no.
FastFix sanding pad, Ø 90 mm (soft-HT), StickFix sanding pad V93, Festool PROTECTOR, in SYSTAINER SYS 2 T-LOC	
RO 90 DX FEQ-Plus GB 240V	571821
RO 90 DX FEQ-Plus GB 110V	571822

System accessories from page 134



Abrasives from page 150



Four tools in one.

One machine that can be used for coarse sanding, fine sanding, polishing and delta sanding. Low initial costs, maximum flexibility and a wide range of applications. More efficient and saves more time.

Machining surfaces

Geared eccentric sander ROTEX RO 125



ROTEX RO 125



Handy all-rounder.

- ▶ A powerful motor and combination of eccentric and orbital motion removes material three times faster than conventional eccentric sanders
- ▶ Three tools in one for coarse sanding, fine sanding and polishing
- ▶ Healthy, efficient dust extraction with the Jetstream principle
- ▶ FastFix sanding pad system, tool-less

Technical data

Power consumption (W)	500
ROTEX rotary motion speed (min ⁻¹)	300 – 600
Eccentric motion speed (min ⁻¹)	3.000 – 6.000
Sanding stroke (mm)	3,6
FastFix sanding pad dia. (mm)	125
Dust extraction connection dia. (mm)	27
Weight (kg)	1,9



■ = MMC Multi Material Control electronics

Items included

RO 125 FEQ Plus GB 240V
FastFix sanding pad Ø 125 mm (soft-HT), Festool PROTECTOR,
in SYSTAINER SYS 2 T-LOC

Order no.

571784

Extremely durable.

With robust eccentric bearings, a double-sealed housing and dustproof switches, the ROTEX can even withstand long periods of continuous use.

System accessories from page 135



Abrasives from page 150





product design award
2006

ROTEX RO 150



The original 3-in-1 principle with powerful machine concept.

- ▶ Three tools in one for coarse sanding, fine sanding and polishing
- ▶ FastFix sanding pad system, tool-less
- ▶ Eccentric motion for high-quality, scratch-free surfaces
- ▶ Sanding up to the edge thanks to the Festool PROTECTOR

Technical data

Power consumption (W)	720
ROTEX rotary motion speed (min ⁻¹)	320 – 660
Eccentric motion speed (min ⁻¹)	3.300 – 6.800
Sanding stroke (mm)	5
FastFix sanding pad dia. (mm)	150
Dust extraction connection dia. (mm)	27
Weight (kg)	2,3



■ = MMC Multi Material Control electronics

Items included

FastFix sanding pad Ø 150 mm (soft HT), Festool PROTECTOR, in SYSTAINER SYS 3 T-LOC

Order no.

RO 150 FEQ-Plus GB 240V	575072
RO 150 FEQ-Plus GB 110V	575073



Short tooling times thanks to FastFix pad change.

Simple, quick and safe. You don't need any other tools for changes apart from your hands. Simply remove the pad, replace and carry on working...

System accessories from page 136



Abrasives from page 150



Machining surfaces

ETS 125 R eccentric sander

ETS 125 R



Better handling, less strenuous work.

The ergonomic design of the compact sander is ideal for one-handed operation – for right and left-handers. The machine is perfectly balanced so that sanding pads run smoothly, allowing you to work effortlessly for longer.

The compact one-handed sander.

- ▶ Work effortlessly: Thanks to the compact design, weight of just 1.2 kg and a perfectly balanced weight distribution
- ▶ Up to 25% greater material removal capacity: The MMC control electronics transfer the power of 250 watts directly to the work surface
- ▶ A healthy working environment and less rework: In combination with the mobile dust extractor or the long-life dust collection bag and attachable PROTECTOR for smooth sanding along window surfaces, frames and panelling
- ▶ For continuous use: Long-life dust collection bag which can be emptied and reused, made from extra-durable nonwoven polyester

Technical data

Power consumption (W)	250
Eccentric motion speed (min ⁻¹)	6.000 – 12.000
Sanding stroke (mm)	2
Interchangeable sanding pad dia. (mm)	125
Dust extraction connection dia. (mm)	27
Weight (kg)	1,2



■ = Electronic

Items included	Order no.
StickFix sanding pad Ø 125 mm (soft-HT), Festool PROTECTOR, long-life chip collection bag	
ETS 125 REQ GB 240V in carton	201238
ETS 125 REQ-Plus GB 240V in SYSTEMER SYS 2 T-LOC	201233

System accessories from page 137



Abrasives from page 150



Machining surfaces

ETSC 125 cordless random orbit sander

NEW



Brushless EC-TEC motor for a long service life and a high level of efficiency

03

ETSC 125



The ergonomic cordless one-handed sander.

- ▶ Mobile and effortless: Without cable and hose, with perfect ergonomics, low height and a weight of just 1.4 kg
- ▶ Powerful: The 18 V battery pack in combination with the brushless EC-TEC motor ensures power similar to that of a mains-powered tool
- ▶ No interruptions: Thanks to battery packs with a capacity of 3.1 Ah which run for longer than their charge time
- ▶ Unlimited running time: For continuous electrical operation, the battery pack can be replaced with the plug-in mains adapter (included in the set and available as an accessory)

Technical data

Battery voltage (V)	18
Li-ion battery capacity (Ah)	3,1
Idle engine speed (min ⁻¹)	6.000 – 10.000
Sanding stroke (mm)	2
Interchangeable sanding pad dia. (mm)	125
Dust extraction connection dia. (mm)	27
Weight with Li-ion (kg)	1,4



■ = MMC Multi Material Control electronics

Items included	Order no.
StickFix sanding pad Ø 125 mm (soft-HT), Festool PROTECTOR, long-life chip collection bag	
ETSC 125 Li-Basic without battery pack, without charger, in SYSTAINER SYS 2 T-LOC	201533
ETSC 125 Li 3,1-Plus GB 2 x BP 18 Li 3.1 ERGO battery pack, rapid charger TCL 6, in SYSTAINER SYS 2 T-LOC	201528
ETSC 125 Li 3,1-Set GB 2 x BP 18 Li 3.1 ERGO battery pack, rapid charger TCL 6, ACA 18 V ERGO mains adapter, in SYSTAINER SYS-Combi 2	201529

Maximum mobility.

Work effortlessly overhead, vertically or in hard-to-reach areas – without power cable and hose, with perfect ergonomics and a weight of just 1.4 kg (including battery), perfectly balanced weight distribution and low height.

System accessories from page 137



Abrasives from page 150



Machining surfaces

ETS EC 125 eccentric sander

Brushless EC-TEC motor for a long service life and a high level of efficiency



ETS EC 125



Compact exterior, clever interior.

The ETS EC 125/3 is a favourite for fine sanding and extra-fine sanding in the compact class. As a one-handed sander with an excellent power to weight ratio, it produces an excellent surface quality with a 3 mm sanding stroke.

The perfect finishing sander in the compact class.

- ▶ Longlife thanks to EC technology and sanding pad brake with carbide tip
- ▶ Continuously variable speed and constant speed control under load
- ▶ Ideally positioned push-button prevents inadvertent switching on and off
- ▶ With Jetstream sanding pad for optimum dust extraction

Technical data

Power consumption (W)	400
Eccentric motion speed (min ⁻¹)	6.000 – 10.000
Sanding stroke (mm)	3
Interchangeable sanding pad dia. (mm)	125
Dust extraction connection dia. (mm)	27
Weight (kg)	1,2



■ = MMC Multi Material Control electronics

Items included

ETS EC 125/3 EQ-Plus GB
StickFix sanding pad Ø 125 mm (soft-HT), operation tool,
in SYSTEMER SYS 2 T-LOC

Order no.

574637

System accessories from page 137



Abrasives from page 150





ETS 150



Perfect finishing sander.

- ▶ The ETS 150 is available in two versions: With a 3 mm sanding stroke for an immaculate surface finish or with a 5 mm sanding stroke for intermediate sanding of clear coats or lacquer
- ▶ Dual bearing for a long service life
- ▶ Weighs only 1.8 kg for particularly effortless work
- ▶ Sanding pad brake for safe, faultless work with no reworking costs

Technical data	ETS 150/3	ETS 150/5
Power consumption (W)	310	310
Eccentric motion speed (min ⁻¹)	4.000 – 10.000	4.000 – 10.000
Sanding stroke (mm)	3	5
Interchangeable sanding pad dia. (mm)	150	150
Dust extraction connection dia. (mm)	27	27
Weight (kg)	1,8	1,8



■ = MMC Multi Material Control electronics

Items included	Order no.
filter cartridge, operation tool, in SYSTAINER SYS 3 T-LOC	
ETS 150/3EQ-Plus GB 240V StickFix sanding pad Ø 150 mm MULTI-JETSTREAM 2 (extra-soft)	575024
ETS 150/3 EQ-Plus GB110V StickFix sanding pad Ø 150 mm MULTI-JETSTREAM 2 (extra-soft)	575030
ETS 150/5 EQ-Plus GB 240V StickFix sanding pad Ø 150 mm MULTI-JETSTREAM 2 (soft HT)	575061
ETS 150/5 EQ-Plus GB 110V StickFix sanding pad Ø 150 mm MULTI-JETSTREAM 2 (soft HT)	575064

System accessories
from page 138



Abrasives
from page 150

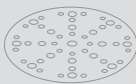

Perfect surface quality.

The ETS 150/3 is a favourite for fine sanding and extra-fine sanding. A lightweight in its class, it produces an excellent surface finish with a 3 mm sanding stroke. The ETS 150/5, with a 5 mm stroke, is a favourite for light sanding or sanding between paint coats. Its manoeuvrability is an example of outstanding ergonomics.

Machining surfaces

Random orbit sander ETS EC 150

Brushless EC-TEC motor for a long service life and a high level of efficiency



ETS EC 150



Sanding has many sides. We've thought of them all.

Overhead, at vertical areas or narrow edges – the new ETS EC 150 takes up position in all circumstances: Perfection with handling and sanding result. Thanks to the high-performance and brushless EC-TEC motor, the compact ETS EC 150 is ideal for one-handed and effortless work with simultaneously high demands for smooth running and surface quality.

The perfect finishing sander in the compact class.

- ▶ Stepless speed preselection, constant speed even under load
- ▶ Very high surface quality thanks to 3 mm sanding stroke
- ▶ Longlife thanks to EC technology and sanding pad brake with carbide tip
- ▶ Compact design and weighing only 1.2 kg for optimal ergonomic work conditions

Technical data	ETS EC 150/3	ETS EC 150/5
Power consumption (W)	400	400
Eccentric motion speed (min ⁻¹)	6.000 – 10.000	6.000 – 10.000
Sanding stroke (mm)	3	5
Interchangeable sanding pad dia. (mm)	150	150
Dust extraction connection dia. (mm)	27	27
Weight (kg)	1,2	1,2



☐ = MMC Multi Material Control electronics

Items included	Order no.
operation tool, in SYSTAINER SYS 2 T-LOC	
ETS EC 150/3 EQ-Plus GB StickFix sanding pad Ø 150 mm MULTI-JETSTREAM 2 (extra-soft)	575036
ETS EC 150/3 EQ-Plus-GQ GB StickFix sanding pad Ø 150 mm MULTI-JETSTREAM 2 (extra-soft), suction hose D27/22x3.5 m AS-GQ (in a SYS 3 T-LOC SYSTAINER)	575401
ETS EC 150/5 EQ-Plus GB 240V StickFix sanding pad Ø 150 mm MULTI-JETSTREAM 2 (soft HT)	575048
ETS EC 150/ 5EQ-Plus-GQ GB StickFix sanding pad Ø 150 mm MULTI-JETSTREAM 2 (soft HT), suction hose D27/22x3.5 m AS-GQ (in a SYS 3 T-LOC SYSTAINER)	575406

System accessories
from page 138



Abrasives
from page 150





**What is the best way to obtain a perfect surface?
With a system.**

Rapid material removal and fine sanding pattern as a basis for the perfect finish or preparing high gloss surface. In no other area is the system concept as evident as the development of our sanding tools. Robust, ergonomic tools that were designed to be used effortlessly for long periods. With individually adapted pads and abrasive sheets for transferring force perfectly and abrasives developed with the same care as the machines themselves.

A system concept that focusses on perfect tools and perfect results as well as the people we design our tools for.

The sanding pad system.

Sanding pads suitable for every type of application are available in different degrees of hardness ranging from extra-soft to hard. Easy to change with Jetstream principle that reduces surface heat and ensures efficient dust extraction.

Abrasive system.

Adapted perfectly to every tool, pad and dust extractor. Individually designed for every application, from coarse to fine sanding. Festool abrasives have an extended useful life and are fast and easy to change due to the StickFix adhesive cushion strips.

The extraction and workspace system.

A well-planned workplace saves time and journeys. A good dust extraction system keeps the air free of dust and ensures consistent quality results while preventing the lungs from inhaling sanding dust.



Machining surfaces

Orbital sander RUTSCHER RS 100



product
design
award

2001



RUTSCHER RS 100



High material removal rate.

Festool gear-drive sanders with reduction gearing are always designed for heavy-duty material removal and are therefore suitable for sanding old, thick and stubborn coatings over large surfaces.

Professional with integral extractor.

- ▶ Reduction gearing for consistently efficient material removal – perfect for sanding off stubborn coatings
- ▶ Vibration stop for smooth operation and safe working conditions
- ▶ Clean working environment – efficient dust extraction for a clear view of the working area and a workplace free from dust
- ▶ Well-balanced centre of gravity for outstanding results and non-tiring work

Technical data

Power consumption (W)	520
Idle engine speed (min ⁻¹)	7.000
No. of strokes (min ⁻¹)	14.000
Sanding stroke (mm)	5
Interchangeable sanding pad (mm)	115 x 221
Dust extraction connection dia. (mm)	27
Weight (kg)	3



Items included

RS 100 Q-Plus GB 240V
StickFix sanding pad 115 x 225 mm, filter cartridge,
in SYSTAINER SYS 2 T-LOC

Order no.

567884

System accessories from page 139

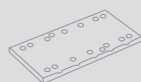

Abrasives from page 150

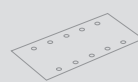



RUTSCHER RS 200



Master of large surfaces.

- ▶ Large sanding pad and high speed for an excellent surface quality in intermediate sanding and final sanding of clear coats and lacquer without requiring rework
- ▶ Large sanding base for economical sanding over large areas
- ▶ Ability to sand up to the edge on three sides
- ▶ The enclosed dust proof bearing and high tear-resistant MPE sanding pad ensure a long service life and maximum economic efficiency

Technical data

Power consumption (W)	330
Idle engine speed (min ⁻¹)	4.000 – 10.000
No. of strokes (min ⁻¹)	8.000 – 20.000
Sanding stroke (mm)	2,4
Interchangeable sanding pad (mm)	115 x 225
Dust extraction connection dia. (mm)	27
Weight (kg)	2,5



= Electronic

Perfect sanding finish.

The RS 200 produces outstanding quality over large surfaces: it has a 2.4 mm sanding stroke and direct drive; its large sanding pad ensures economical intermediate varnish and final sanding, eg light sanding of doors or large surface areas on furniture. The ability to sand right into corners and edges minimises reworking.

Items included

StickFix sanding pad 115 x 225 mm, filter cartridge

Order no.

RS 200 EQ-Plus GB 240V
in SYSTAINER SYS 2 T-LOC

567881

System accessories from page 139

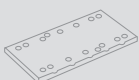

Abrasives from page 150

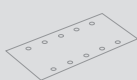

Machining surfaces

Orbital sander RUTSCHER RS 300



product
design
award

2001

RUTSCHER RS 300



A multi-talent.

- ▶ Interchangeable sanding pads for an extremely wide range of applications
- ▶ Optimal ratio between size, weight and sanding pad – for effortless work
- ▶ Ergonomic design – ideal even for vertical areas and overhead
- ▶ The sturdy bearing, screw-fastened oscillators and extremely tear-resistant MPE sanding pad ensure a long service life

Technical data	RS 300 EQ	RS 300 Q
Power consumption (W)	280	280
Power consumption (W)	280	
Idle engine speed (min ⁻¹)	4.000 – 10.000	10.000
No. of strokes (min ⁻¹)	8.000 – 20.000	20.000
Sanding stroke (mm)	2,4	2,4
Interchangeable sanding pad (mm)	93 x 175	93 x 175
Dust extraction connection dia. (mm)	27	27
Weight (kg)	2,3	2,3



□ = Electronic

not available in Great Britain

When things get a little tight.

Universal application – the RS 300 has the right sanding pad for almost every task.

System accessories
from page 139

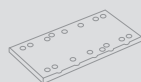

Abrasives
from page 150

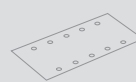



RUTSCHER RTS 400 R

Compact one-handed sander.

- ▶ Work effortlessly: Thanks to the compact design, weight of just 1.2 kg and a perfectly balanced weight distribution
- ▶ Up to 25% greater material removal capacity: The MMC control electronics transfer the power of 250 watts directly to the work surface
- ▶ A healthy working environment and less rework: In combination with the mobile dust extractor or the long-life dust collection bag and attachable PROTECTOR for smooth sanding along window surfaces, frames and panelling
- ▶ For continuous use: Long-life dust collection bag which can be emptied and reused, made from extra-durable nonwoven polyester



Technical data	
Power consumption (W)	250
Idle engine speed (min ⁻¹)	6.000 – 12.000
No. of strokes (min ⁻¹)	12.000 – 24.000
Sanding stroke (mm)	2
Interchangeable sanding pad (mm)	80 x 130
Dust extraction connection dia. (mm)	27
Weight (kg)	1,2



■ = Electronic

Items included	Order no.
StickFix sanding pad 80 x 130 mm, Festool PROTECTOR, long-life chip collection bag, StickFix abrasive discs	
RTS 400 REQ GB 240V in carton	201225
RTS 400 REQ-Plus GB 240V in SYSTAINER SYS 2 T-LOC	201220

Clean working environment.

Efficient dust extraction for a clear view of the working area and a workplace free from dust.

System accessories from page 140

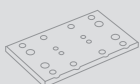

Abrasives from page 150

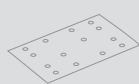

Machining surfaces

RTSC 400 cordless orbital sander

NEW

Brushless EC-TEC motor for a long service life and a high level of efficiency



RUTSCHER RTSC 400



Unique: With battery or cable.

For all applications which require an even longer operating performance, the 18 V battery pack can be replaced with the plug it mains adapter (included in the set and available as an accessory). This creates a mains-powered machine with an unlimited running time for continuous electrical operation in combination with the plug it cable – ideal in conjunction with a Festool mobile dust extractor.

The ergonomic one-handed cordless orbital sander.

- ▶ Mobile and effortless: Without cable and hose, with perfect ergonomics, low height and a weight of just 1.4 kg
- ▶ Powerful: The 18 V battery pack in combination with the brushless EC-TEC motor ensures power similar to that of a mains-powered tool
- ▶ No interruptions: Thanks to battery packs with a capacity of 3.1 Ah which run for longer than their charge time
- ▶ Unlimited running time: For continuous electrical operation, the battery pack can be replaced with the plug-in mains adapter (included in the set and available as an accessory)

Technical data

Battery voltage (V)	18
Li-ion battery capacity (Ah)	3,1
Idle engine speed (min ⁻¹)	6.000 - 10.000
Sanding stroke (mm)	2
Interchangeable sanding pad (mm)	80 x 130
Dust extraction connection dia. (mm)	27
Weight with Li-ion (kg)	1,4



■ = MMC Multi Material Control electronics

Items included	Order no.
StickFix sanding pad 80 x 130 mm, Festool PROTECTOR, long-life chip collection bag	
RTSC 400 Li-Basic without battery pack, without charger, in SYSTAINER SYS 2 T-LOC	201519
RTSC 400 Li 3,1-Plus GB 2 x BP 18 Li 3.1 ERGO battery pack, rapid charger TCL 6, in SYSTAINER SYS 2 T-LOC	201514
RTSC 400 Li 3,1-Set GB 2 x BP 18 Li 3.1 ERGO battery pack, rapid charger TCL 6, ACA 18 V ERGO mains adapter, in SYSTAINER SYS-Combi 2	201515

System accessories
from page 140

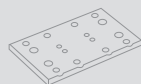

Abrasives
from page 150

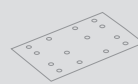



DTS 400 R



Compact corner sander.

- ▶ Work effortlessly: Thanks to the compact design, weight of just 1.2 kg and a perfectly balanced weight distribution
- ▶ Up to 25% greater material removal capacity: The MMC control electronics transfer the power of 250 watts directly to the work surface
- ▶ A healthy working environment and less rework: In combination with the mobile dust extractor or the long-life dust collection bag and attachable PROTECTOR for smooth sanding along window surfaces, frames and panelling
- ▶ For continuous use: Long-life dust collection bag which can be emptied and reused, made from extra-durable nonwoven polyester

Technical data

Power consumption (W)	250
Idle engine speed (min ⁻¹)	6.000 – 12.000
Sanding stroke (mm)	2
Interchangeable sanding pad (mm)	100 x 150
Dust extraction connection dia. (mm)	27
Weight (kg)	1,2



■ = Electronic

Items included

DTS 400 REQ-Plus GB 240V
StickFix sanding pad 100 x 150 mm, Festool PROTECTOR,
long-life chip collection bag, in SYSTAINER SYS 2 T-LOC

Order no.

201227

Sanding in corners and along edges.

Perfect preparation of windows and doors – the DTS 400 with iron-shaped pad can be guided accurately along narrow edges and into corners.

System accessories from page 140



Abrasives from page 150



Machining surfaces

DTSC 400 cordless delta sander

NEW

Brushless EC-TEC motor for a long service life and a high level of efficiency



DTSC 400



Less reworking.

PROTECTOR for smooth sanding along window surfaces, frames and panelling.

The ergonomic cordless corner sander.

- ▶ Mobile and effortless: Without cable and hose, with perfect ergonomics, low height and a weight of just 1.4 kg
- ▶ Powerful: The 18 V battery pack in combination with the brushless EC-TEC motor ensures power similar to that of a mains-powered tool
- ▶ No interruptions: Thanks to battery packs with a capacity of 3.1 Ah which run for longer than their charge time
- ▶ Unlimited running time: For continuous electrical operation, the battery pack can be replaced with the plug-in mains adapter (included in the set and available as an accessory)

Technical data

Battery voltage (V)	18
Li-ion battery capacity (Ah)	3,1
Idle engine speed (min ⁻¹)	6.000 - 10.000
Sanding stroke (mm)	2
Interchangeable sanding pad (mm)	100 x 150
Dust extraction connection dia. (mm)	27
Weight with Li-ion (kg)	1,4



■ = MMC Multi Material Control electronics

Items included	Order no.
StickFix sanding pad 100 x 150 mm, Festool PROTECTOR, long-life chip collection bag	
DTSC 400 Li-Basic without battery pack, without charger, in SYSTAINER SYS 2 T-LOC	201526
DTSC 400 Li 3,1-Plus GB 2 x BP 18 Li 3.1 ERGO battery pack, rapid charger TCL 6, in SYSTAINER SYS 2 T-LOC	201521
DTSC 400 Li 3,1-Set GB 2 x BP 18 Li 3.1 ERGO battery pack, rapid charger TCL 6, ACA 18 V ERGO mains adapter, in SYSTAINER SYS-Combi 2	201522

System accessories
from page 140



Abrasives
from page 150





DUPLEX LS 130



Profile sander.

- ▶ Linear motion provides an efficient alternative to manual work in rebates and profiles for non-tiring work
- ▶ A variety of different sanding pads and abrasives for a wide range of applications
- ▶ Simple, quick and tool-less sanding pad changes
- ▶ Wear-resistant design for a long service life

Technical data

Power consumption (W)	260
Idle engine speed (min ⁻¹)	4.000 – 6.000
No. of strokes (min ⁻¹)	8.000 – 12.000
Sanding stroke (mm)	4
Interchangeable sanding pad (mm)	133 x 80
Dust extraction connection dia. (mm)	27
Weight (kg)	1,7



■ = Electronic

Items included

LS 130 EQ-Plus GB 240V
StickFix profile sanding pad standard, profile sanding pad 90°,
in SYSTAINER SYS 1 T-LOC

Order no.

567853

Curves and profiles.

The DUPLEX is ideal for sanding curves and profiles, thanks to its linear motion, the DIY kit and a large selection of sanding pads.

System accessories
from page 141

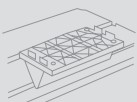

Abrasives
from page 150

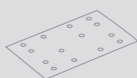

Machining surfaces

Rotary sander RAS 180



RAS 180



MMC electronics.

Smooth start-up, controlled speed and a temperature control to protect against overload make the RAS ideal for demanding, continuous use.

Large heavy-duty sander.

- ▶ Particularly economical when used over large areas, as the machine is designed for high material removal rates and fast work progress
- ▶ Optimum dust extraction ensures a clean workspace, a clear view and a healthy working environment
- ▶ Health-friendly – anti-static equipment for the reliable removal of clear coats on metal, extraction hood for the perfect extraction of fine dust particles and chips
- ▶ Tool-less sanding pad change

Technical data

Power consumption (W)	1.500
Idle engine speed (min ⁻¹)	800 – 4.000
Interchangeable sanding pad dia. (mm)	180
Spindle	M14
Dust extraction connection dia. (mm)	27
Weight (kg)	4,2



■ = MMC Multi Material Control electronics

Items included

RAS 180 E GB 240V
StickFix sanding pad Ø 180, extraction hood, StickFix abrasive discs, operation tool, in carton

Order no.

575440

System accessories
from page 142



Abrasives
from page 150





PLANEX easy LHS-E 225

Drywalling has never been so easy.

- ▶ Simply sand for longer: The first long-reach sander from Festool which does not need to be assembled and set up
- ▶ The even balance between control and advantageous weight distribution means that you can work for sustained periods
- ▶ The lightest long-reach sander with direct drive on the market



Technical data

Power consumption (W)	400
Idle engine speed (min ⁻¹)	400 – 920
Interchangeable sanding pad dia. (mm)	215
Abrasive dia. (mm)	225
Length (m)	1,6
Dust extraction connection dia. (mm)	36/27
Weight (kg)	4



■ = MMC Multi Material Control electronics

Items included	Order no.
StickFix sanding pad LHS-E Ø 215 mm, LHS-E 225-BAG carrying bag, in carton	
LHS-E 225 EQ GB 110V	571939
LHS-E 225/CTM36-Set GB110V	575458
CTM 36 E AC-LHS mobile dust extractor	

Convenient and reliable.

Optimum results in every position. Whether on ceilings or walls – this product makes sanding extremely simple in any position thanks to its low weight and highly flexible head section.

System accessories from page 143



Abrasives from page 150

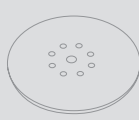

Machining surfaces

Long-reach sander PLANEX LHS 225



PLANEX LHS 225



Efficient short-reach or long-reach sanding on walls and ceilings.

- ▶ Two lengths, one machine – extend or reduce in a few simple hand movements
- ▶ Two-speed gears for efficient, rapid material removal on walls and ceilings
- ▶ Perfectly balanced for easy handling
- ▶ Robust, reliable drive components and efficient power transfer

Technical data

Power consumption (W)	550
Idle engine speed (min ⁻¹)	340 – 910
Interchangeable sanding pad dia. (mm)	215
Dust extraction connection dia. (mm)	36/27
Weight (length 1.60 m) (kg)	4,6
Weight (length 1.10 m) (kg)	3,8



☐ = MMC Multi Material Control electronics

Items included

StickFix 215 mm diameter sanding pad including 2 interface pads, in SYSTAINER SYS MAXI

LHS 225 EQ-Plus/IP GB 110V

Order no.

571720

LHS 225-IP/CTM36-Set GB 110V

mobile dust extractor CTM 36E AC PLANEX

575457

Working near edges.

When sanding the area between two adjacent walls or a ceiling and wall, the PLANEX LHS 225 produces absolutely consistent results when sanding right up to the edge because of its removable brush segment.

System accessories from page 143



Abrasives from page 150





BS 75



Manoeuvrable belt sander.

- ▶ Precision adjustment after every belt change for maximum accuracy
- ▶ The well-balanced centre of gravity of the longitudinally mounted motor ensures non-tiring work
- ▶ Perfect system accessories – the belt sanders can be quickly combined with the bench-mounted set for permanent installation in the bodyshop
- ▶ Strong motor pulling force ensures economic working

Technical data

Power consumption (W)	700
Belt speed, rated load (m/min)	315
Belt length x belt width (mm)	533 x 75
Sanding area (mm)	135 x 75
Dust extraction connection dia. (mm)	27/36
Weight (kg)	3,8



Items included	Order no.
----------------	-----------

dust bag, stationary unit, extraction adapter, slip band P100, in SYSTAINER SYS MAXI

BS 75 E-Plus GB 240 V	575438
------------------------------	---------------

BS 75 E-Set GB 240V surface sanding frame	570254
---	---------------

Smooth touch down.

The sanding frame can be positioned gently and securely, the belt sander does not tilt and is easy to guide.

System accessories
from page 144

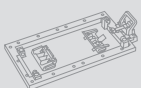

Abrasives
from page 150



Machining surfaces

BS 105 belt sander

BS 105



Stationary use.

With the bench unit, you can turn a mobile belt sander into a stationary unit in an instant, allowing you to machine smaller workpieces more efficiently.



Wide belt sander.

- ▶ Precision adjustment after every belt change for maximum accuracy
- ▶ The well-balanced centre of gravity of the longitudinally mounted motor ensures non-tiring work
- ▶ Perfect system accessories – the belt sanders can be quickly combined with the bench-mounted set for permanent installation in the bodyshop
- ▶ Strong motor pulling force ensures economic working

Technical data

Power consumption (W)	1.000
Belt speed, rated load (m/min)	380
Belt length x belt width (mm)	620 x 105
Sanding area (mm)	160 x 105
Dust extraction connection dia. (mm)	27/36
Weight (kg)	6,5



Items included	Order no.
dust bag, stationary unit, extraction adapter, slip band P100, in SYSTAINER SYS MAXI	
BS 105 E-Plus GB 240V	570235
BS 105 E-Set GB 240V surface sanding frame	570234

System accessories
from page 144

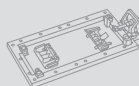

Abrasives
from page 150



CMS-BS



The belt sander for the CMS system.

- ▶ Possibility of lowering the sanding belt for full belt utilisation, achieving greater efficiency
- ▶ Quick, simple belt changing – short changeover times
- ▶ Tilting sanding belt for sanding chamfers and sloping surfaces with ease
- ▶ Powerful motor for sanding large areas with minimum effort

Technical data

Power consumption (W)	550
Idle engine speed (min ⁻¹)	2.800
Belt length x belt width (mm)	820 x 120
Sanding area (mm)	185 x 185
Dust extraction connection dia. (mm)	27
Dimensions module support (mm)	578 x 320



not available in Great Britain

Open to change.

The CMS Compact Module System consists of a basic unit and compatible modules that transform the unit into a stationary bench-mounted saw, jigsaw, bench-mounted router or belt sander.

CMS system overview
from page 396



System accessories
from page 414



Machining surfaces



Designed for continuous operation.

Extremely robust, durable and reliable. Ideal for heavy-duty applications in paintshops or the industrial sector because compressed air sanders are low-maintenance and significantly lighter than electric power tools.

The extremely robust design provides durability, the innovative IAS 3 system ensures perfect dust extraction and low vibration levels and lower operating noises for a healthy working environment.

Three times the benefits – the Festool IAS 3 system.

The unique IAS 3 system combines three functions in one hose: compressed air supply, exhaust air extraction and dust extraction. Sanding dust and exhaust air are kept away from the working area, the surface remains clean and the resulting surface finish is excellent. The compressed air tool operates more quietly due to sound absorption elements in the hose. An intelligently designed exhaust air system prevents the discharge of cold air onto the hands and wrists and makes your work more enjoyable and healthier.





LEX 3 77

For surface finishing.

- ▶ Extremely sturdy design ensures a long service life, minimal servicing requirements and high cost savings
- ▶ Pleasant operating noise, low vibration levels and safe dispersion of exhaust air through a compressed air hose protects the health of the user
- ▶ Sanding pad brake reduces sanding errors when setting down the machine, thereby avoiding rework and additional costs
- ▶ Low compressed air consumption ensures high cost savings



Technical data	
Operating pressure (flow pressure) (bar)	6
No. of strokes (min ⁻¹)	21.000
Eccentric motion speed (min ⁻¹)	10.500
Sanding stroke (mm)	2,5
Vibration emission value Ah (single-axle) (m/s ²)	0,8
Vibration emissions value Ah (three-axle) (m/s ²)	1,9
Air consumption at rated load (l/min)	270
Sanding pad dia. (mm)	77
Sound pressure level (dB[A])	72
Weight (kg)	0,8



Items included	Order no.
LEX 3 77/2,5 StickFix sanding pad Ø 77 mm W-HT (soft), operation tool, in carton	691131

For extreme durability.

For smooth processes free of machine failures and maintenance.

The IAS 3 connection system is required to operate the compressed air sanders.

System accessories
from page 145



Abrasives
from page 150



Machining surfaces

Compressed air eccentric sander LEX 3 125



2012

LEX 3 125



No possibility of confusion.

Clearly visible stroke indicator on the dead-man switch of all LEX 3 models makes it easy to select the correct machine.



Saves compressed air without affecting results.

- ▶ Low compressed air consumption ensures high cost savings
- ▶ Low vibration levels and a pleasant operating noise protect the user's health
- ▶ Extremely sturdy design ensures a long service life, minimal servicing requirements and high cost savings
- ▶ Simplifies permanent dust extraction, guarantees the best working results and protects the user's health when combined with the IAS 3 light hose

Technical data	LEX 3 125/3	LEX 3 125/5
Operating pressure (flow pressure) (bar)	6	6
No. of strokes (min ⁻¹)	19.000	19.000
Eccentric motion speed (min ⁻¹)	9.500	9.500
Sanding stroke (mm)	3	5
Vibration emission value Ah (single-axle) (m/s ²)	1,1	1,1
Vibration emissions value Ah (three-axle) (m/s ²)	3,6	4,2
Air consumption at rated load (l/min)	290	290
Sound pressure level [dB(A)]	70	70
Sanding pad dia. (mm)	125	125
Weight (kg)	1	1



Items included	Order no.
operation tool, in carton	
LEX 3 125/3 StickFix sanding pad Ø 125 mm (extra soft)	691140
LEX 3 125/5 StickFix sanding pad Ø 125 mm (soft-HT)	691141

The IAS 3 connection system is required to operate the compressed air sanders.

System accessories
from page 145



Abrasives
from page 150





2013

03

LEX 3 150



Stops vibrations. Increases efficiency.

- ▶ Precise – sanding pad brake ensures a clean pattern
- ▶ Low compressed air consumption ensures high cost savings
- ▶ Perfect dust extraction and economic abrasive consumption – thanks to the high-quality sanding pad with MULTI-JETSTREAM 2 principle
- ▶ Low vibration levels and a pleasant operating noise protect the user's health

Technical data	LEX 3 150/3	LEX 3 150/5	LEX 3 150/7
Operating pressure (flow pressure) (bar)	6	6	6
No. of strokes (min ⁻¹)	20.000	20.000	20.000
Eccentric motion speed (min ⁻¹)	10.000	10.000	10.000
Sanding stroke (mm)	3	5	7
Vibration emission value Ah (single-axle) (m/s ²)	2,1	2,7	3,17
Vibration emissions value Ah (three-axle) (m/s ²)	3,7	3,9	5,8
Air consumption at rated load (l/min)	290	290	310
Sound pressure level (dB[A])	72	72	76
Sanding pad dia. (mm)	150	150	150
Weight (kg)	1	1	1



Items included	Order no.
operation tool, in carton	
LEX 3 150/3 StickFix sanding pad Ø 150 mm MULTI-JETSTREAM 2 (extra-soft)	574996
LEX 3 150/5 StickFix sanding pad Ø 150 mm MULTI-JETSTREAM 2 (soft HT)	575081
LEX 3 150/7 StickFix sanding pad Ø 150 mm MULTI-JETSTREAM 2 (soft HT)	575077

Safe and healthy.

The non-slip soft grip cap on the LEX 3 provides a secure hold. Dust extraction with the MULTI-JETSTREAM 2 principle keeps the air and workpiece clean.

The IAS 3 connection system is required to operate the compressed air sanders.

System accessories from page 145



Abrasives from page 150



Machining surfaces

Compressed air orbital sander LRS 93

LRS 93



Vibration stop

Less stress on your hands and wrists. VS balancing reduces vibrations and oscillations, and is kind to both you and your machine.



Perfect for flat surfaces.

- ▶ Machine is easy to guide
- ▶ Variable speed preselection
- ▶ Reduced vibrations for maximum working comfort
- ▶ Robust motor for a longer lifespan

Technical data

Operating pressure (flow pressure) (bar)	6
No. of strokes (min ⁻¹)	14.000
Sanding stroke (mm)	4
Air consumption at rated load (l/min)	310
Sanding pad StickFix (mm)	93 x 175
Weight (kg)	1,5



Items included

LRS 93M
StickFix sanding pad 93 x 175 mm, bottle of cleaning and lubricating oil LFC 9022 (50 ml), in carton

Order no.

574811

The IAS 3 connection system is required to operate the compressed air sanders.

System accessories from page 147

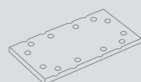

Abrasives from page 150

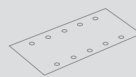



LRS 400

Long sander for large surfaces.

- ▶ Lightweight and handy despite its size
- ▶ High material removal rate on large, flat surfaces
- ▶ Highly effective dust extraction
- ▶ Softgrip handle

Technical data

Operating pressure (flow pressure) (bar)	6
No. of strokes (min ⁻¹)	14.000
Sanding stroke (mm)	4
Air consumption at rated load (l/min)	390
Sanding pad StickFix (mm)	80 x 400
Weight (kg)	2,1



Items included

LRS 400
StickFix sanding pad 80 x 400 mm (soft), bottle of cleaning and lubricating oil LFC 9022 (50 ml), in carton

Order no.

574813



Easy guidance.

All compressed air orbital sanders are easy to guide, both with one or two hands. The Softgrip and the additional handle on the LRS 400 give you complete control of the machine.

The IAS 3 connection system is required to operate the compressed air sanders.

System accessories
from page 147

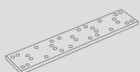

Abrasives
from page 150

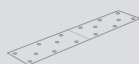

Perfect surfaces from a single source: **Polishing and oiling with Festool.**

Detail of success.

Festool creates a perfect interaction between machine, polishing pad, foam pad and abrasive: for sensitive working and gleaming results on different materials from the word go, without any rework. For high-gloss paints, UV clear coats, mineral materials or acrylic glass.





Oil application in its cleanest form.

Festool also offers a fully adapted system for producing a perfectly oiled surface finish – the SURFIX oil dispenser provides quick, clean and ecological surface protection of the highest quality in combination with high-quality natural oils.



HEAVY-DUTY

Protection for furniture, worktops and all heavily worn indoor surfaces:
HEAVY-DUTY special oil



ONE-STEP

A gleaming finish and smooth to the touch:
the ONE-STEP oil/wax mixture for decorative indoor surfaces.



OUTDOOR

OUTDOOR universal oil is ideal for weatherproofing all types of wood used in external applications.



Sustainable, high-quality ingredients –
Festool natural oils.

Machining surfaces

Rotary polisher SHINEX RAP 150



product
design
award

2009



SHINEX RAP 150



All-purpose genius.

- ▶ Accelerator switch, speed preselection, controlled speed, smooth start-up
- ▶ Can take heavy loading because of its 2-speed motor
- ▶ Long service life – a temperature-dependent overload protection and filter catcher protect the machine
- ▶ Longer working due to ergonomic handling and light weight

Technical data	RAP 150-14 FE	RAP 150-21 FE
Power consumption (W)	1.200	1.200
Idle engine speed (min ⁻¹)	600 – 1.400	900 – 2.100
Max. polishing pad dia. (mm)	150	150
Spindle	M14	M14
Weight (kg)	2,1	2,1



= MMC Multi Material Control electronics

Precise application of power.

Perfect power transfer thanks to the minimum distance between the tool and pad and the various grip positions of the SHINEX RAP 150.

Items included	Order no.
additional side-mounted hand grip, StickFix polishing pad Ø 150 mm, in carton	
RAP 150-14 FE GB 240V	570816
RAP 150-21 FE GB 240V	571008

System accessories
from page 170

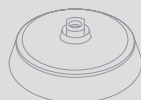

Polishing accessories
from page 175

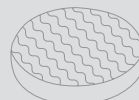

POLLUX 180



Powerhouse with high coverage capacity.

- ▶ Exceptional cooling in lower speed range – allows work under heavy loads
- ▶ Controlled speed, stepless speed preselection and smooth start-up for adaptation to the working surface
- ▶ Accelerator switch, speed preselection, controlled speed, smooth start-up
- ▶ Ergonomic dome grip and perfect weight distribution for relaxed work

Technical data

Power consumption (W)	1.500
Idle engine speed (min ⁻¹)	800 – 2.400
Max. polishing pad dia. (mm)	180
Spindle	M14
Weight (kg)	3,6



■ = MMC Multi Material Control electronics

When faced with demanding tasks.

The POLLUX 180 E enables perfect adaptation to different materials and surfaces. The motor speed always remains constant thanks to the MMC electronics and allows you to work evenly without damaging the workpiece and avoid time-consuming reworking.

not available in Great Britain

System accessories
from page 170



Polishing accessories
from page 171



Machining surfaces

SURFIX OS oil dispenser



2012

SURFIX OS



Oil application in its cleanest form.

- ▶ Excellent ergonomic design: the full bottle clicks in and serves as a handle
- ▶ Cleanliness: the safety valve ensures simple metering, closes the oil bottle and protects the oil from drying out
- ▶ Clearly more economical than using a brush or cloth: the sponge with attached StickFix absorbs excesses and dispenses them again in the right places
- ▶ For every application area – Heavy-Duty, One-Step and Outdoor oil grades for all interior and exterior applications and light or dark woods. All high-quality natural oils, free of solvents and ecologically safe

Items included	Order no.
base plate	
OS-Set HD 0,3 l StickFix oil sponge, heavy-duty oil bottle, 0,3 l, in white tin	498060
OS-Set OS 0,3 l StickFix oil sponge, one-step oil bottle, 0,3 l, in white tin	498061
OS-Set OD 0,3 l StickFix oil sponge, outdoor oil bottle, 0,3 l, in white tin	498062
OS-SYS3-Set heavy-duty oil bottle, 0,3 l, one-step oil bottle, 0,3 l, outdoor oil bottle, 0,3 l, 5 x StickFix oil sponge, 5 x green non-woven sanding pad, 5 x white non-woven sanding pad, 10 x sanding discs STF-D150 P180 RU2, 10 x sanding discs STF-D150 P240 BR2, in SYSTAINER SYS 3 T-LOC	498063

Safe and clean.

The foam pad remains soft and reusable for long periods when stored in the tin provided.

System accessories from page 177



More on natural oils from page 127





RUSTOFIX BMS 180



Quick, fix, RUSTOFIX.

- ▶ Three working steps with one tool: Texturing, intermediate sanding and smoothing
- ▶ Adjustable support rollers for precise setting of the texturing depth
- ▶ Quick, easy brush changes
- ▶ Overload protection for a long service life

Technical data

Power consumption (W)	1.500
Idle engine speed (min ⁻¹)	800 – 4.000
Tool dia. (mm)	150
Spindle	M14
Dust extraction connection dia. (mm)	27
Weight (kg)	7,5



■ = MMC Multi Material Control electronics

The quick way to produce a rustic wood effect.

The RUSTOFIX is the perfect tool for anyone wishing to lend a rustic touch to wooden surfaces – while guaranteeing maximum reliability and saving as much time and money as possible. Whether in furniture manufacture, building renovation or timber restoration.

Items included

BMS 180 E GB 240V
LD 85 brush, KB 85 brush, extraction hood, tool arbour, Clamping flange, operation tool, in case

Order no.

575441

System accessories
from page 149

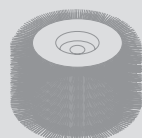

The Festool system.

Because things work better when everything fits together: When sanding, for example. Almost all Festool abrasives and sanding pads are changed without requiring tools and adapted perfectly to the relevant sander as well as the overall system.



Machining surfaces

Accessories and consumable materials

Surface preparation

System accessories	134
Abrasives	150

Polishing

System accessories	170
Polishing agent	171
Foam polishing pads	173

Oils

System accessories	177
--------------------	-----



Machining surfaces

System accessories

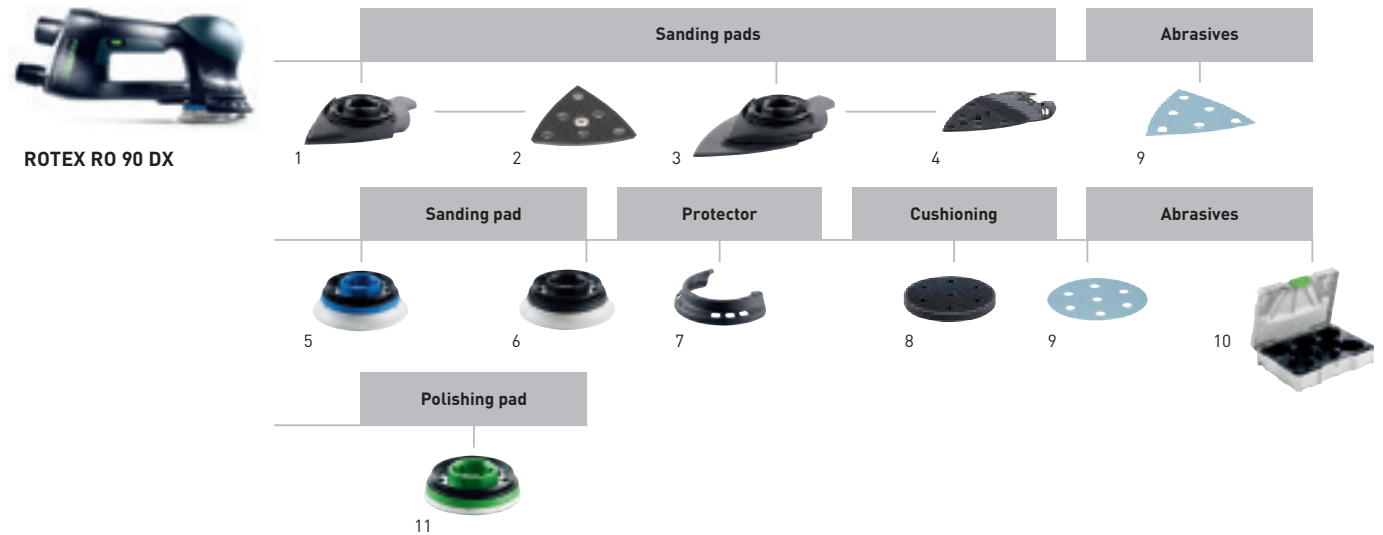

Accessories for geared eccentric sander ROTEX RO 90 DX

Denomination	Explanation	Order no.
1 Sanding pad SSH-GE-STF-R090 DX	suitable for abrasive 93 V, delta sanding pad, plate without interchangeable sanding pad, for attaching StickFix sanding pad, soft and hard, connecting thread FastFix, qty. in pack 1 piece(s), in self-service display pack	496802
2 Sanding pad StickFix, soft SSH-STF-V93/6-W/2	for DX 93 and RO 90 DX, with snap stud, StickFix, qty. in pack 2 piece(s), in self-service display pack	488715
Sanding pad StickFix, hard SSH-STF-V93/6-H/2	for DX 93 and RO 90 DX, with snap stud, StickFix, qty. in pack 2 piece(s), in self-service display pack	488716
3 Sanding pad LSS-STF-R090 V93/6	suitable for abrasive 93 V, plate incl. interchangeable sanding pad, slat sanding pad V93, for sanding in tight spaces, in self-service display pack	496803
4 Sanding pad LSS-STF-R090 V93 E	replacement backing pad for slat sanding pad, in self-service display pack	497483
5 FastFix sanding pad dia ST-STF D90/7 FX H-HT	hard version, Fastener resistant to high temperatures, for plain surfaces and narrow edges, connecting thread FastFix, qty. in pack 1 piece(s), in self-service display pack	495623
6 FastFix sanding pad dia ST-STF D90/7 FX W-HT	soft version, Fastener resistant to high temperatures, for universal use on plain and arced surfaces, connecting thread FastFix, qty. in pack 1 piece(s), in self-service display pack	496804
7 Protector set FP-RO 90	for RO 90 DX, window protectors S, M, L, qty. in pack 3 piece(s), in self-service display pack	497936
Protector FESTOOL 90FX	for RO 90 DX, for protecting the sanding pad and workpiece, in self-service display pack	496801
8 Interface pad IP-STF-D90/6	as damping element between sanding disc and sanding pad, Interface pad D 90 mm, height 15 mm, qty. in pack 1 piece(s), diameter 90 mm, in self-service display pack	497481
9 Abrasives	from page 152	
10 SYSTAINER T-LOC SYS-STF-D77/D90/93V	with insert for Ø 90 mm abrasives and 93V abrasives, dimensions (L x W x H) 396 x 296 x 105 mm, number of compartments 8, SYSTAINER size SYS 1 T-LOC	497687
11 FastFix polishing pad PT-STF-D90 FX-R090	for RO 90 DX, for holding polishing accessories with dia. 80 mm, Polishing edges, Polishing small surfaces, diameter 75 mm, in self-service display pack	495625



ROTEX RO 125



Accessories for geared eccentric sander ROTEX RO 125

Denomination	Explanation	Order no.
1 FastFix sanding pad dia ST-STF D125/8 FX-H-HT	hard version, Fastener resistant to high temperatures, high edge solidity, for plain surfaces and narrow edges, connecting thread FastFix, qty. in pack 1 piece(s), in self-service display pack	492127
2 FastFix sanding pad dia ST-STF D125/8 FX-W-HT	soft version, Fastener resistant to high temperatures, for universal use on plain and arced surfaces, connecting thread FastFix, qty. in pack 1 piece(s), in self-service display pack	492125
3 FastFix sanding pad dia ST-STF D125/8 FX-SW	ultra-soft version, elastic structure, for heavy roundings and cambers, connecting thread FastFix, qty. in pack 1 piece(s), in self-service display pack	492126
4 FastFix louver pad LT-STF D125/RO125	FastFix, for sanding louvers, diameter 150 mm, in self-service display pack	492129
5 Protector FESTOOL 125FX	for RO 125 FEQ, for protecting the sanding pad and workpiece, in self-service display pack	493912
6 Interface pad IP-STF-D120/8-J	for sanding contoured parts and fine-sanding parts with eccentric sander Ø 125 mm, as damping element between sanding disc and sanding pad, JETSTREAM, height 15 mm, diameter 120 mm, hole circle diameter 90 mm, qty. in pack 1 piece(s), in self-service display pack	492271
7 Abrasives	from page 155	
8 SYSTAINER T-LOC SYS-STF D125	with insert for abrasives Ø 125 mm, dimensions [L x W x H] 396 x 296 x 105 mm, number of compartments 5, SYSTAINER size SYS 1 T-LOC	497685
9 FastFix polishing pad PT-STF-D125 FX-RO125	for RO 125 FEQ, fits polishing accessories, diameter 115 mm, height 10 mm, in self-service display pack	492128

Machining surfaces

System accessories



Accessories for geared eccentric sander ROTEX RO 150

Denomination	Explanation	Order no.
1 FastFix sanding pad dia ST-STF D150/MJ2-FX-H-HT	for RO 150, hard version, Fastener resistant to high temperatures, high edge solidity, for plain surfaces and narrow edges, MULTI-JETSTREAM 2, diameter 150 mm, connecting thread FastFix, qty. in pack 1 piece(s), in self-service display pack	202463
2 FastFix sanding pad dia ST-STF D150/MJ2-FX-W-HT	for RO 150, soft version, Fastener resistant to high temperatures, for universal use on plain and arced surfaces, MULTI-JETSTREAM 2, diameter 150 mm, connecting thread FastFix, qty. in pack 1 piece(s), in self-service display pack	202461
3 FastFix sanding pad dia ST-STF D150/MJ2-FX-SW	for RO 150, ultra-soft version, elastic structure, for heavy roundings and cambers, MULTI-JETSTREAM 2, diameter 150 mm, connecting thread FastFix, qty. in pack 1 piece(s), in self-service display pack	202462
4 Protector FESTOOL 150FX	for RO 150 FEQ, for protecting the sanding pad and workpiece, in self-service display pack	493913
5 Interface pad IP-STF D150/MJ2-5/2	for eccentric sander with diameter of 150 mm, as damping element between sanding disc and sanding pad, MULTI-JETSTREAM 2, optimal thickness for sanding work on bodies and similarly shaped components, diameter 145 mm, height 5 mm, qty. in pack 2 piece(s), in self-service display pack	203348
Interface pad IP-STF D150/MJ2-15/1	for eccentric sander with diameter of 150 mm, as damping element between sanding disc and sanding pad, MULTI-JETSTREAM 2, optimal thickness for sanding work on curved components, diameter 145 mm, height 15 mm, in self-service display pack	203351
6 Abrasives	from page 157	
7 SYSTAINER T-LOC SYS-STF D150	with insert for abrasives Ø 150 mm, dimensions [L x W x H] 396 x 296 x 210 mm, number of compartments 10, SYSTAINER size SYS 3 T-LOC	497690
8 FastFix polishing pad PT-STF-D150 FX	for RO 150 FEQ, fits polishing accessories, diameter 135 mm, height 10 mm, in self-service display pack	496151
Polishing pad PT-STF-D150 M8	for RO 150, fits polishing accessories, diameter 135 mm, height 10 mm, in self-service display pack	496152
9 Additional hand grip ZG-RAS/RO	for RO 150, RAS, WTS 150, in carton	487865
Handle BG-RO 150	for RO 150 FEQ, in self-service display pack	495188

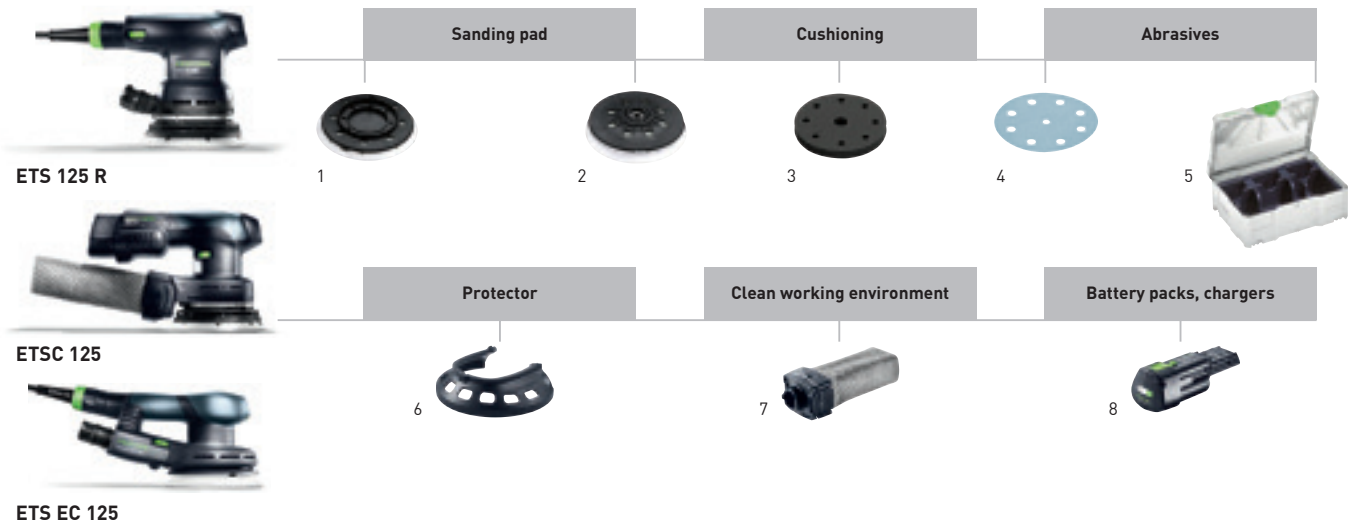

Accessories for ETS 125 R, ETSC 125, ETS EC 125 random orbit sanders

Denomination	Explanation	Order no.
1 Sanding pad ST-STF 125/8-M4-J W-HT	for ES 125, ETS 125, soft version, Fastener resistant to high temperatures, for universal use on plain and arced surfaces, for robust use with grit up to P220, JETSTREAM, connecting thread M4, hole circle diameter 90 mm, qty. in pack 1 piece(s), in self-service display pack	492280
Sanding pad ST-STF 125/8-M4-J SW	for ES 125, ETS 125, ultra-soft version, elastic structure, for heavy roundings and cambers, JETSTREAM, connecting thread M4, hole circle diameter 90 mm, qty. in pack 1 piece(s), in self-service display pack	492282
2 Sanding pad ST-STF 125/8-M8-J H	for ETS EC 125, LEX 125, hard version, Fastener resistant to high temperatures, high edge solidity, for plain surfaces and narrow edges, JETSTREAM, connecting thread M8, qty. in pack 1 piece(s), in self-service display pack	492284
Sanding pad ST-STF 125/8-M8-J W-HT	for ETS EC 125, LEX 125, soft version, Fastener resistant to high temperatures, for universal use on plain and arced surfaces, JETSTREAM, connecting thread M8, qty. in pack 1 piece(s), in self-service display pack	492286
Sanding pad ST-STF 125/8-M8-J SW	for ETS EC 125, LEX 125, ultra-soft version, elastic structure, for heavy roundings and cambers, JETSTREAM, connecting thread M8, qty. in pack 1 piece(s), in self-service display pack	492288
3 Interface pad IP-STF-D120/8-J	for sanding contoured parts and fine-sanding parts with eccentric sander Ø 125 mm, as damping element between sanding disc and sanding pad, JETSTREAM, height 15 mm, diameter 120 mm, hole circle diameter 90 mm, qty. in pack 1 piece(s), in self-service display pack	492271
4 Abrasives	from page 155	
5 SYSTAINER T-LOC SYS-STF D125	with insert for abrasives Ø 125 mm, dimensions (L x W x H) 396 x 296 x 105 mm, number of compartments 5, SYSTAINER size SYS 1 T-LOC	497685
6 Protector PR ETS-R 125	for ETS 125 RQ, ETSC 125, for smooth sanding along window panes, frames and panelling, for protecting the sanding pad and workpiece, in self-service display pack	201690
7 Long-life chip collection bag SB-Longlife RTS/DTS/ETS	for ETS 125, ETSC 125, RTS 400, RTSC 400, DTS 400, DTSC 400, for holding dust and for dust-free disposal of the extracted product, can be discharged multiple times and is wear resistant thanks to high-strength, durable nonwoven polyester, in self-service display pack	201693
8 Battery pack BP 18 Li 3,1 Ergo	for RTSC 400, DTSC 400, ETSC 125 cordless sanders, not suitable for all other cordless machines, ergonomic, lightweight design, tensioner 18 V, capacity 3,1 Ah, weight 0,4 kg, in self-service display pack	202499
Mains adapter ACA 220-240/18V Ergo	for RTSC 400, DTSC 400, ETSC 125 cordless sanders, not suitable for all other cordless machines, for continuous electrical operation of the RTSC 400, DTSC 400, ETSC 125 cordless sanders, ergonomic, lightweight design, plug it power cable (4 m), input voltage 220 – 240 V, tensioner 18 – 20 V, rated power 150 W, weight 0,3 kg, in self-service display pack	202503

Machining surfaces

System accessories

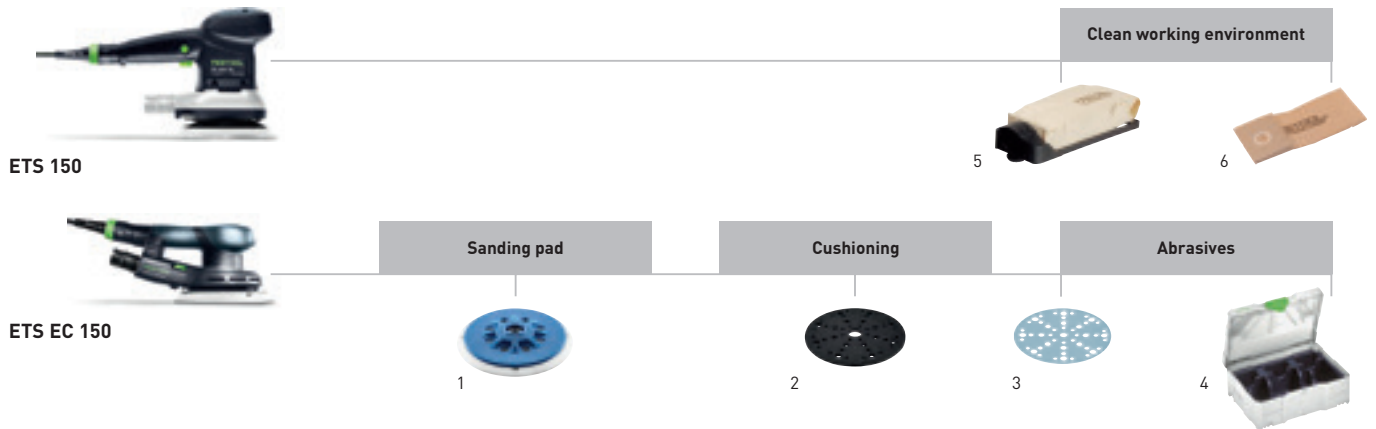

Accessories for ETS 150, ETS EC 150 eccentric sanders

Denomination	Explanation	Order no.
1 Sanding pad ST-STF D150/MJ2-M8-H-HT	for ETS 150, ETS EC 150, LEX 150 and WTS 150/7, hard version, Fastener resistant to high temperatures, high edge solidity, for plain surfaces and narrow edges, MULTI-JETSTREAM 2, diameter 150 mm, connecting thread M8, qty. in pack 1 piece(s), in self-service display pack	202460
Sanding pad ST-STF D150/MJ2-M8-W-HT	for ETS 150, ETS EC 150, LEX 150 and WTS 150/7, soft version, Fastener resistant to high temperatures, for universal use on plain and arced surfaces, MULTI-JETSTREAM 2, diameter 150 mm, connecting thread M8, qty. in pack 1 piece(s), in self-service display pack	202458
Sanding pad ST-STF D150/MJ2-M8-SW	for ETS 150, ETS EC 150, LEX 150 and WTS 150/7, ultra-soft version, elastic structure, for heavy roundings and cambers, MULTI-JETSTREAM 2, diameter 150 mm, connecting thread M8, qty. in pack 1 piece(s), in self-service display pack	202459
2 Interface pad IP-STF D150/MJ2-5/2	for eccentric sander with diameter of 150 mm, as damping element between sanding disc and sanding pad, MULTI-JETSTREAM 2, optimal thickness for sanding work on bodies and similarly shaped components, diameter 145 mm, height 5 mm, qty. in pack 2 piece(s), in self-service display pack	203348
Interface pad IP-STF D150/MJ2-15/1	for eccentric sander with diameter of 150 mm, as damping element between sanding disc and sanding pad, MULTI-JETSTREAM 2, optimal thickness for sanding work on curved components, diameter 145 mm, height 15 mm, in self-service display pack	203351
3 Abrasives	from page 157	
4 SYSTAINER T-LOC SYS-STF D150	with insert for abrasives Ø 150 mm, dimensions [L x W x H] 396 x 296 x 210 mm, number of compartments 10, SYSTAINER size SYS 3 T-LOC	497690
5 Turbo filter bag set TFS-ES 150	for ES 150, ETS 150, for clear view and healthy working environment, not suitable for ETS EC 125/150, filter cartridge, turbofilter, in self-service display pack	489631
6 Turbo filter bag TF II-RS/ES/ET/25	for RS 300, RS 3, RS 200, RS 2, ES 150, ETS 150, ET 2, for insertion in filter cartridge, qty. in pack 25 piece(s), in carton	487871
Turbo filter bag TF II-RS/ES/ET/5	for RS 300, RS 3, RS 200, RS 2, ES 150, ETS 150, ET 2, for insertion in filter cartridge, qty. in pack 5 piece(s), in self-service display pack	487779

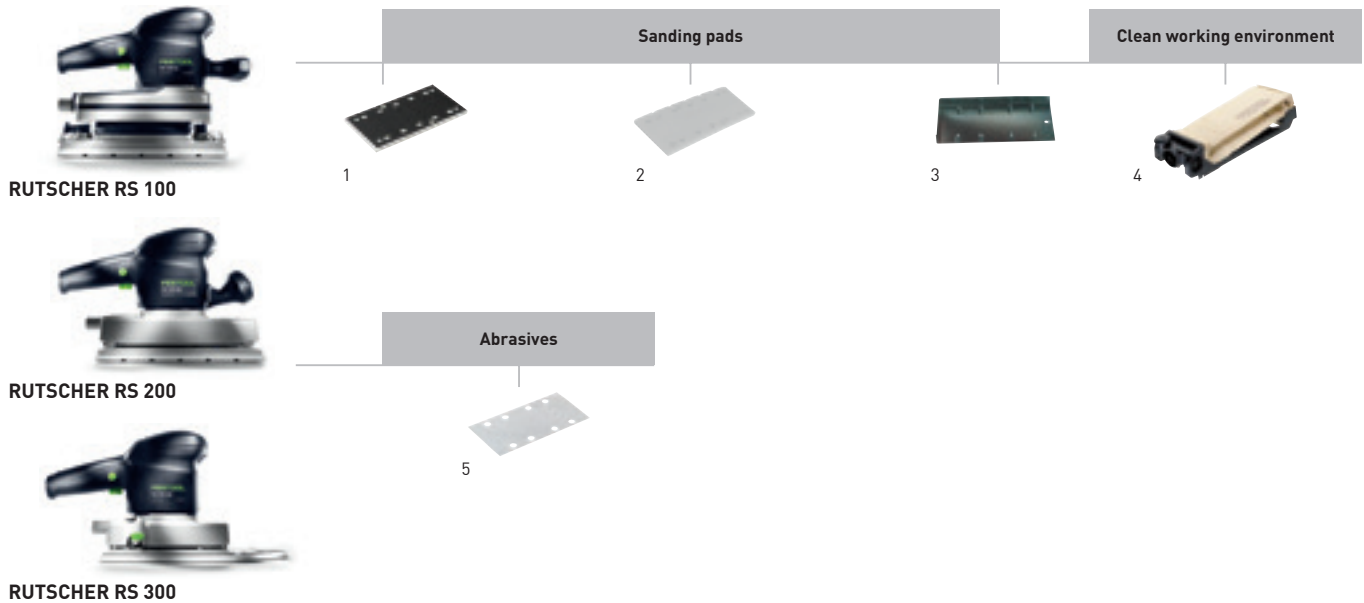

Accessories for RUTSCHER RS 100, RS 200, RS 300

Denomination	Explanation	Order no.
1 Sanding pad StickFix SSH-STF-115x221/10 RS 1 C	for RS 100 C, RS 1 C, StickFix adhesive layer for quick change of sanding pad, min. length 115 mm, width 221 mm, dimensions 115 x 221 mm, in self-service display pack	488226
Sanding pad SSH 115x221/10-RS 1 C	for RS 100 C, RS 1 C, for abrasives for clamping, width 221 mm, min. length 115 mm, dimensions 115 x 221 mm, in self-service display pack	492310
Sanding pad StickFix SSH-STF-115x225/10	for RS 200, RS 2, RS 100, RS 1, StickFix adhesive layer for quick change of sanding pad, dimensions 115 x 225 mm, in self-service display pack	483679
Sanding pad StickFix SSH-STF-115x225/10-KS	for RS 200, RS 2, RS 100, RS 1, with edge protection, width 225 mm, min. length 115 mm, dimensions 115 x 225 mm, in self-service display pack	485648
Sanding pad StickFix SSH-STF-93x175/8	for RS 300, RS 3, LRS 93, StickFix adhesive layer for quick change of sanding pad, width 175 mm, min. length 93 mm, dimensions 93 x 175 mm, in self-service display pack	483905
StickFix slat sanding pad SSH-STF-L93x230/0	for RS 300, RS 3, LRS 93, lamellar sanding pad version, width 230 mm, min. length 93 mm, dimensions 93 x 230 mm, in self-service display pack	486371
StickFix iron sanding pad SSH-STF-V93x266/14	for RS 300, RS 3, LRS 93, pressing iron sanding pad version, width 266 mm, min. length 93 mm, dimensions 93 x 266 mm, in self-service display pack	486418
2 Sanding pad SSH-115x225/10	for RS 200, RS 2, RS 100, RS 1, for abrasives for clamping, min. length 115 mm, width 225 mm, dimensions 115 x 225 mm, in self-service display pack	489629
Sanding pad SSH-115x225/10-KS	for RS 200, RS 2, RS 100, RS 1, with edge protection, for abrasives for clamping, width 225 mm, min. length 115 mm, dimensions 115 x 225 mm, in self-service display pack	485647
Sanding pad SSH-93x175/8	for RS 300, RS 3, LRS 93, for abrasives for clamping, min. length 93 mm, width 175 mm, dimensions 93 x 175 mm, in self-service display pack	489630
3 Hole punch 10L 115x225	for RS 200, RS 2, RS 100, RS 100 C, RS 1, RS 1 C, HSK 115 x 226, for preparing the Festool hole pattern, no. of holes 10, in self-service display pack	481523
4 Turbo filter bag TF-RS 1/5	for RS 100, RS 1, paper filter bag for turbo dust extraction, for insertion in filter cartridge, qty. in pack 5 piece(s), in self-service display pack	483674
Turbo filter bag TF II-RS/ES/ET/25	for RS 300, RS 3, RS 200, RS 2, ES 150, ETS 150, ET 2, for insertion in filter cartridge, qty. in pack 25 piece(s), in carton	487871
Turbo filter bag TF II-RS/ES/ET/5	for RS 300, RS 3, RS 200, RS 2, ES 150, ETS 150, ET 2, for insertion in filter cartridge, qty. in pack 5 piece(s), in self-service display pack	487779
Turbo filter bag set TFS II-ET/RS	for RS 300, RS 3, RS 200, RS 2, ET2, for clear view and healthy working environment, filter cartridge, 5 x turbofilter, in self-service display pack	487780
5 Abrasives	from page 163	

Machining surfaces

System accessories

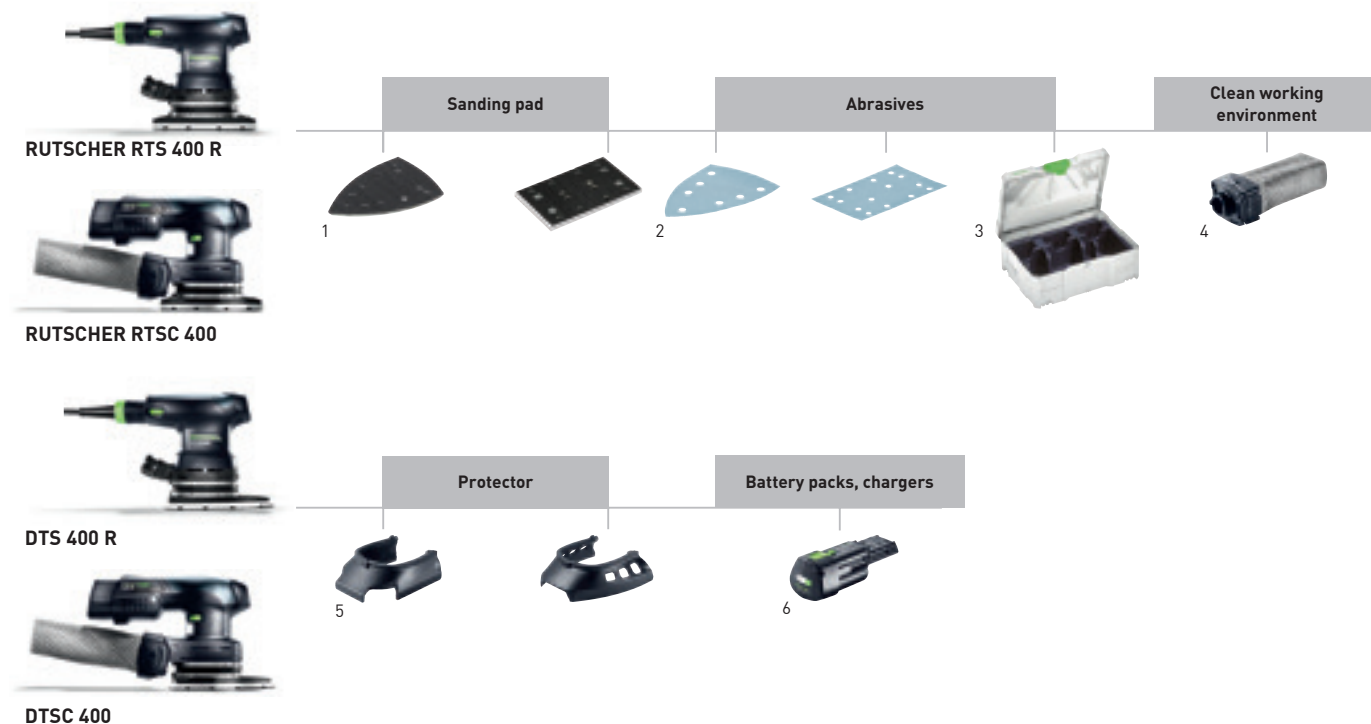

Accessories for RUTSCHER RTS 400 R, RTSC 400 orbital sanders, DTS 400 R, DTSC 400 delta sanders

Denomination	Explanation	Order no.
1 Sanding pad StickFix SSH-STF-80x130/8	for RS 4, perforated with eight suction holes, min. length 80 mm, width 130 mm, dimensions 80 x 130 mm, in self-service display pack	483906
Sanding pad SSH-80x130/8	for RS 4, for abrasives for clamping, width 130 mm, min. length 80 mm, dimensions 80 x 130 mm, in self-service display pack	491366
Sanding pad StickFix SSH-STF-80x130/12	for RTS 400, RS 400, RTSC 400, perforated with 12 suction holes, width 130 mm, min. length 80 mm, dimensions 80 x 130 mm, in self-service display pack	489252
Sanding pad SSH-STF-Delta100x150/7	for DTS 400, DS 400, DTSC 400, for sanding even in corners, width 150 mm, min. length 100 mm, dimensions 100 x 150 mm, in self-service display pack	493723
2 Abrasives	from page 160	
3 SYSTAINER T-LOC SYS-STF 80x133	with insert for abrasives 80x133 mm, dimensions [L x W x H] 396 x 296 x 105 mm, number of compartments 6, SYSTAINER size SYS 1 T-LOC	497684
SYSTAINER T-LOC SYS-STF Delta 100x150	with insert for abrasives STF Delta 100x150, dimensions [L x W x H] 396 x 296 x 105 mm, number of compartments 5, SYSTAINER size SYS 1 T-LOC	497686
SYSTAINER T-LOC SYS-STF-D77/D90/93V	with insert for Ø 90 mm abrasives and 93V abrasives, dimensions [L x W x H] 396 x 296 x 105 mm, number of compartments 8, SYSTAINER size SYS 1 T-LOC	497687
4 Long-life chip collection bag SB-Longlife RTS/DTS/ETS	for ETS 125, ETSC 125, RTS 400, RTSC 400, DTS 400, DTSC 400, for holding dust and for dust-free disposal of the extracted product, can be discharged multiple times and is wear resistant thanks to high-strength, durable nonwoven polyester, in self-service display pack	201693
5 Protector PR RTS-R 80x133	for RTS 400 REQ, RTSC 400, for smooth sanding along window panes, frames and panelling, for protecting the sanding pad and workpiece, in self-service display pack	201691
Protector PR DTS-R 100x150	for DTS 400 REQ, DTSC 400, for smooth sanding along window panes, frames and panelling, for protecting the sanding pad and workpiece, in self-service display pack	201692
6 Battery pack BP 18 Li 3,1 Ergo	for RTSC 400, DTSC 400, ETSC 125 cordless sanders, not suitable for all other cordless machines, ergonomic, lightweight design, tensioner 18 V, capacity 3,1 Ah, weight 0,4 kg, in self-service display pack	202499
Mains adapter ACA 220-240/18V Ergo	for RTSC 400, DTSC 400, ETSC 125 cordless sanders, not suitable for all other cordless machines, for continuous electrical operation of the RTSC 400, DTSC 400, ETSC 125 cordless sanders, ergonomic, lightweight design, plug it power cable [4 m], input voltage 220 – 240 V, tensioner 18 – 20 V, rated power 150 W, weight 0,3 kg, in self-service display pack	202503

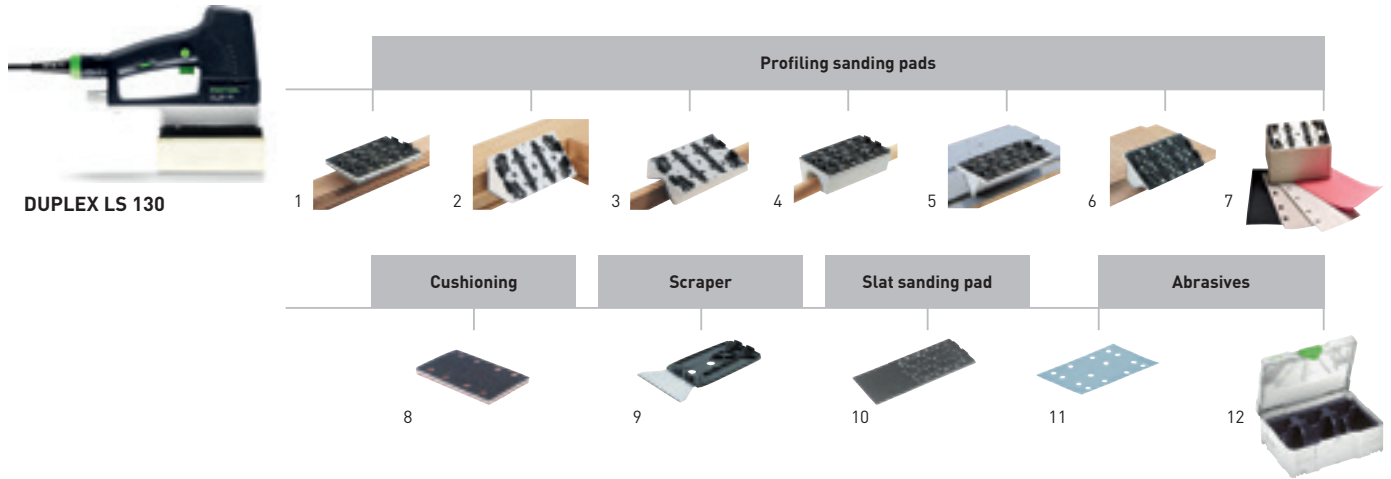

Accessories for linear sander DUPLEX LS 130

Denomination	Explanation	Order no.
1 Flat sanding pad SSH-STF-LS130-F	standard design, dimensions 80 x 130 mm, in self-service display pack	490161
2 Rebate profile sanding pad SSH-STF-LS130-90 GR	90 degrees, dimensions 80 x 130 mm, in self-service display pack	490162
3 Radius profile sanding pad SSH-STF-LS130-R6KV	radius R6 concave, dimensions 80 x 130 mm, in self-service display pack	490163
Radius profile sanding pad SSH-STF-LS130-R10KV	radius R10 concave, dimensions 80 x 130 mm, in self-service display pack	491197
4 Radius profile sanding pad SSH-STF-LS130-R18KV	radius R18, concave, dimensions 80 x 130 mm, in self-service display pack	490164
Radius profile sanding pad SSH-STF-LS130-R25KV	radius R25, concave, dimensions 80 x 130 mm, in self-service display pack	490165
5 V-groove profile sanding pad SSH-STF-LS130-V10	minimum basic dimension of the V-groove 10 mm, dimensions 80 x 130 mm, in self-service display pack	490166
6 Flute profile sanding pad SSH-STF-LS130-R5KX	radius R5 convex, dimensions 80 x 130 mm, in self-service display pack	491198
Flute profile sanding pad SSH-STF-LS130-R12,5KX	radius R12,5, convex, dimensions 80 x 130 mm, in self-service display pack	490167
7 DIY construction kit SSH-STF-LS130 Kit	kit for creating any type of profiling pad, in self-service display pack	490780
8 Interface pad IP-STF-80x133/12-STF LS130/2	damping element between sanding pad and abrasive, dimensions 80 x 133 mm, qty. in pack 2 piece(s), in self-service display pack	490160
9 Scraper SSH-LS130-B100	for removing coatings, width 100 mm, in self-service display pack	491199
10 Flat sanding pad long SSH-STF-LS130-LL195	for relief grinding of facings, dimensions 80 x 195 mm, in self-service display pack	491861
11 Abrasives	from page 161	
12 SYSTAINER T-LOC SYS-STF 80x133	with insert for abrasives 80x133 mm, dimensions (L x W x H) 396 x 296 x 105 mm, number of compartments 6, SYSTAINER size SYS 1 T-LOC	497684

Machining surfaces

System accessories



RAS 180

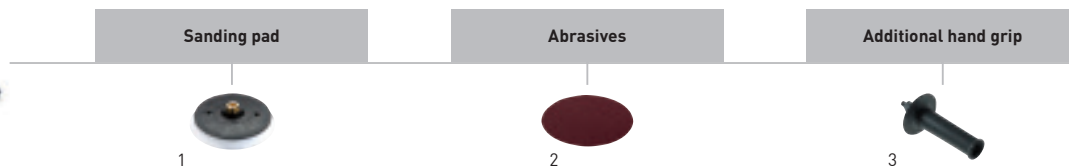

Accessories for rotary sander RAS 180

Denomination	Explanation	Order no.
1 Sanding pad ST-STF-D180/0-M14 W	for RAS 180, soft version, for universal use on plain and arced surfaces, connecting thread M14, in self-service display pack	485253
Sanding pad ST-D180/0-M14/2F	for RAS 180, for fibre discs Ø 180 mm, connecting thread M14, in self-service display pack	485296
2 Abrasives	from page 159	
3 Additional hand grip ZG-RAS/RO	for RO 150, RAS, WTS 150, in carton	487865

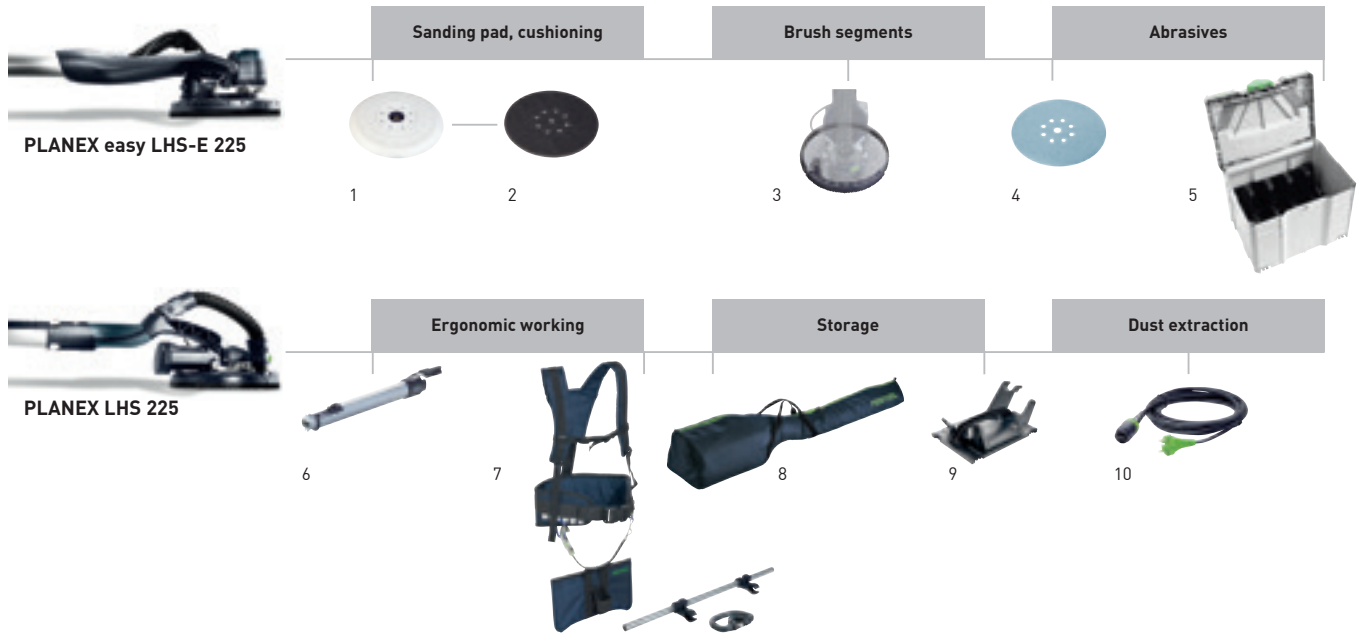

Accessories for PLANEX LHS 225, PLANEX easy LHS-E 225 long-reach sanders

Denomination	Explanation	Order no.
1 Sanding pad ST-STF-D215/8-LHS 225-SW	for long-reach sander PLANEX, for universal use on plain and arced surfaces, ultra-soft, adaptable sanding pad, optimal suction support makes work effortless for the user, not recommended for PLANEX easy LHS-E 225, qty. in pack 1 piece(s), diameter 215 mm, in self-service display pack	202546
Sanding pad ST-STF-D215/8-IP-LHS 225	for long-reach sander PLANEX, for all types of applications, particularly suited for curved surfaces, incl. 2 interface pads, not recommended for PLANEX easy LHS-E 225, diameter 215 mm, in self-service display pack	496106
Sanding pad ST-STF-D215/8-LHS-E	for PLANEX easy LHS-E 225 EQ, for universal use on plain and arced surfaces, Fastener resistant to high temperatures, for heavy-duty applications, not suitable for PLANEX LHS 225 with extraction support, qty. in pack 1 piece(s), diameter 215 mm, in self-service display pack	201895
2 Interface pad IP-STF-D215/8/2x	as damping element between sanding disc and sanding pad, for use with sanding pad 496106, height 5 mm, diameter 215 mm, qty. in pack 2 piece(s), in self-service display pack	496140
3 Brush segment BS-LHS 225	for long-reach sander PLANEX, detachable part of the brush strip of the PLANEX LHS 225 EQ sanding head, in self-service display pack	495166
Brush segment BS-LHS-E 225	for PLANEX easy LHS-E 225 EQ, detachable part of the brush strip of the PLANEX easy LHS-E 225 sanding head, in self-service display pack	203189
Brush strip BE-LHS 225	for long-reach sander PLANEX, as a replacement for used brush strip, in self-service display pack	495167
Brush strip BE-LHS-E 225	for PLANEX easy LHS-E 225 EQ, as a replacement for used brush strip, in self-service display pack	203190
4 Abrasives	from page 159	
5 SYSTAINER T-LOC SYS-STF D225	with insert for abrasive, dia. 225 mm, dimensions [L x W x H] 396 x 296 x 315 mm, number of compartments 3, SYSTAINER size SYS 4 T-LOC	497691
6 Guide extension VL-LHS 225	for long-reach sander PLANEX, quick guide extension of the PLANEX for high ceilings, length 500 mm, in self-service display pack	495169
7 Carrying harness TG-LHS 225	for PLANEX, PLANEX easy long-reach sanders, working aid for sanding ceilings, additional side-mounted hand grip, in SYSTAINER SYS MAXI	496911
Additional hand grip ZG-LHS 225	for PLANEX and carrying harness, in carton	496916
8 Bag LHS-E 225-BAG	for PLANEX easy LHS-E 225 EQ, transport bag with shoulder straps, in carton	202477
9 Tool holder WHR-CT 36-LHS 225	for CT 36 PLANEX, with practical carrier handle, for storing PLANEX, not for PLANEX easy, in carton	495964
10 plug it-cable H05 RN-F/4 EU PLANEX	for PLANEX, PLANEX easy long-reach sanders, rubber insulated cable 240V plug it, particularly suitable for use with the PLANEX LHS 225 thanks to extended cable bushing, for example for sanding work in dry construction, length 4 m, in self-service display pack	499819

Machining surfaces

System accessories



BS 75



BS 105



CMS-MOD BS 120

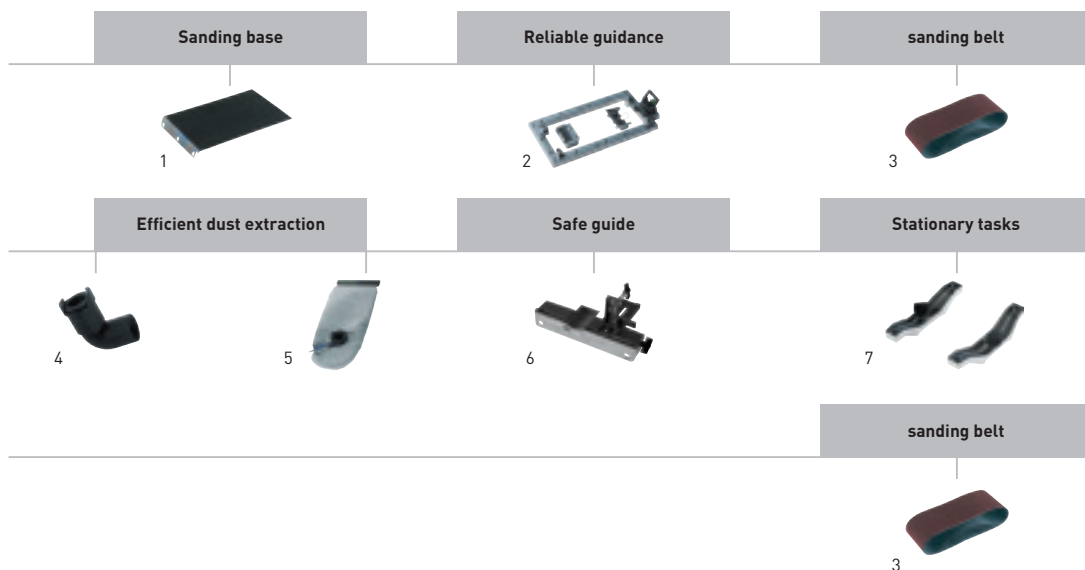

Accessories for belt sanders BS 75, BS 105

Denomination	Explanation	Order no.
1 Sanding base SU/GG-BS 75	for BS 75, from fabric/graphite, qty. in pack 2 piece(s), in self-service display pack	490823
Sanding base SU/KM-BS 75	for BS 75, made from cork/metal for coarse sanding work, qty. in pack 1 piece(s), in self-service display pack	490824
Sanding base SU/GG-BS 105	for BS 105, from fabric/graphite, qty. in pack 2 piece(s), in self-service display pack	490825
Sanding base SU/KM-BS 105	for BS 105, made from cork/metal for coarse sanding work, qty. in pack 1 piece(s), in self-service display pack	490826
2 Sanding frame FSR-BS 75	for BS 75, quick installation without a tool, mounting element, qty. in pack 1 piece(s), in carton	490827
Sanding frame FSR-BS 105	for BS 105, quick installation without a tool, mounting element, qty. in pack 1 piece(s), in carton	490828
3 Abrasive belt	from page 165	
4 Extraction adapter AA-BS 75/105	for BS 75, BS 105, for connecting suction hose to belt sander, in self-service display pack	490818
5 Dust bag AS-BS 75/105	for BS 75, BS 105, in carton	490819
6 Stopper LA-BS 75/105	for BS 75, BS 105, enables flexible sanding of workpieces, in carton	490821
7 Bench unit SE-BS 75/105	for BS 75, BS 105, qty. in pack 2 piece(s), in carton	490820

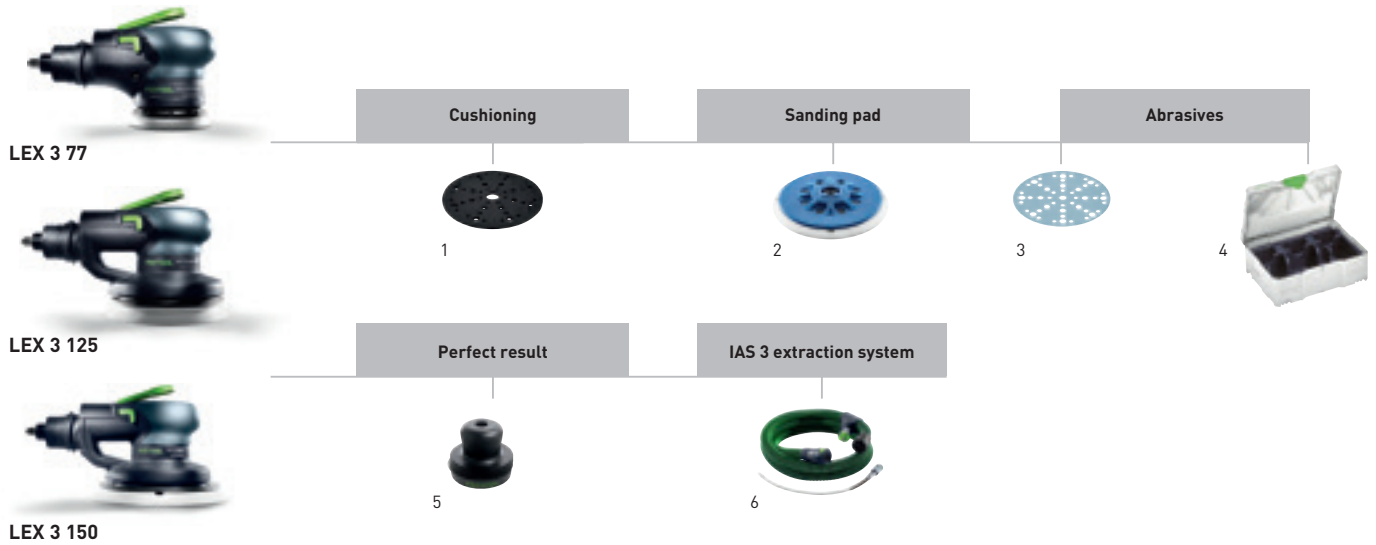

Accessories for LEX 3 77, LEX 3 125, LEX 3 150 compressed air eccentric sanders

Denomination	Explanation	Order no.
1 Interface pad IP-STF-D77/6	for LEX 3 77, as damping element between sanding disc and sanding pad, height 10 mm, diameter 77 mm, qty. in pack 2 piece(s), in self-service display pack	498818
Interface pad IP-STF-D120/8-J	for sanding contoured parts and fine-sanding parts with eccentric sander Ø 125 mm, as damping element between sanding disc and sanding pad, JETSTREAM, height 15 mm, diameter 120 mm, hole circle diameter 90 mm, qty. in pack 1 piece(s), in self-service display pack	492271
Interface pad IP-STF D150/MJ2-5/2	for eccentric sander with diameter of 150 mm, as damping element between sanding disc and sanding pad, MULTI-JETSTREAM 2, optimal thickness for sanding work on bodies and similarly shaped components, diameter 145 mm, height 5 mm, qty. in pack 2 piece(s), in self-service display pack	203348
Interface pad IP-STF D150/MJ2-15/1	for eccentric sander with diameter of 150 mm, as damping element between sanding disc and sanding pad, MULTI-JETSTREAM 2, optimal thickness for sanding work on curved components, diameter 145 mm, height 15 mm, in self-service display pack	203351
2 Sanding pad ST-STF-D77/6-M5 W	for LEX 3 77, soft version, for tough and universal use, diameter 77 mm, connecting thread M5, qty. in pack 1 piece(s), in self-service display pack	498694
Sanding pad ST-STF 125/8-M8-J H	for ETS EC 125, LEX 125, hard version, Fastener resistant to high temperatures, high edge solidity, for plain surfaces and narrow edges, JETSTREAM, connecting thread M8, qty. in pack 1 piece(s), in self-service display pack	492284
Sanding pad ST-STF 125/8-M8-J W-HT	for ETS EC 125, LEX 125, soft version, Fastener resistant to high temperatures, for universal use on plain and arced surfaces, JETSTREAM, connecting thread M8, qty. in pack 1 piece(s), in self-service display pack	492286
Sanding pad ST-STF 125/8-M8-J SW	for ETS EC 125, LEX 125, ultra-soft version, elastic structure, for heavy roundings and cambers, JETSTREAM, connecting thread M8, qty. in pack 1 piece(s), in self-service display pack	492288
Sanding pad ST-STF D150/MJ2-M8-SW	for ETS 150, ETS EC 150, LEX 150 and WTS 150/7, ultra-soft version, elastic structure, for heavy roundings and cambers, MULTI-JETSTREAM 2, diameter 150 mm, connecting thread M8, qty. in pack 1 piece(s), in self-service display pack	202459
Sanding pad ST-STF D150/MJ2-M8-W-HT	for ETS 150, ETS EC 150, LEX 150 and WTS 150/7, soft version, Fastener resistant to high temperatures, for universal use on plain and arced surfaces, MULTI-JETSTREAM 2, diameter 150 mm, connecting thread M8, qty. in pack 1 piece(s), in self-service display pack	202458
Sanding pad ST-STF D150/MJ2-M8-H-HT	for ETS 150, ETS EC 150, LEX 150 and WTS 150/7, hard version, Fastener resistant to high temperatures, high edge solidity, for plain surfaces and narrow edges, MULTI-JETSTREAM 2, diameter 150 mm, connecting thread M8, qty. in pack 1 piece(s), in self-service display pack	202460
Sanding pad ST-STF-D185/16-M8 W	soft version, for universal use on plain and arced surfaces, connecting thread M8, qty. in pack 1 piece(s), in self-service display pack	490514
Sanding pad ST-STF-D185/16-M8 SW	ultra-soft version, elastic structure, for heavy roundings and cambers, connecting thread M8, qty. in pack 1 piece(s), in self-service display pack	490526
3 Abrasives	from page 152	

Machining surfaces

System accessories

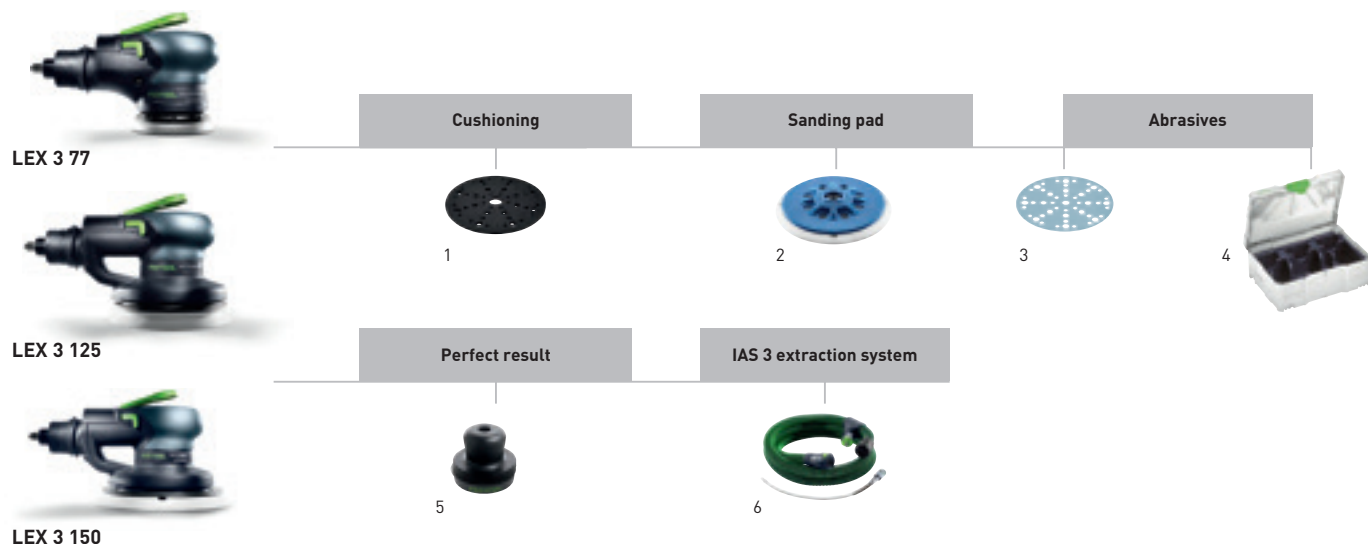

Accessories for LEX 3 77, LEX 3 125, LEX 3 150 compressed air eccentric sanders

Denomination	Explanation	Order no.
4 SYSTAINER T-LOC SYS-STF-D77/D90/93V	with insert for Ø 90 mm abrasives and 93V abrasives, dimensions [L x W x H] 396 x 296 x 105 mm, number of compartments 8, SYSTAINER size SYS 1 T-LOC	497687
SYSTAINER T-LOC SYS-STF D125	with insert for abrasives Ø 125 mm, dimensions [L x W x H] 396 x 296 x 105 mm, number of compartments 5, SYSTAINER size SYS 1 T-LOC	497685
SYSTAINER T-LOC SYS-STF D150	with insert for abrasives Ø 150 mm, dimensions [L x W x H] 396 x 296 x 210 mm, number of compartments 10, SYSTAINER size SYS 3 T-LOC	497690
5 Guide control black powder HB-Set	for visibly checking surfaces to be sanded, hand sanding block, 2 guide control black powder cartridges (each 30 g), in carton	495939
Refillable cartridge 2 x 30 g	refill for the guide control black powder HB set (2 x 30 g), in carton	495940
6 IAS hoses IAS 3	from page 148	
IAS adapter IAS 3-SD	for LEX 3, LEX 2, LRS, for connecting a Festool compressed air sander directly to a compressed air line (without dust extraction), length 90 mm, in carton	497214
Compressed air hose D 12,4 x 5 m	for LEX 3, LEX 2, LRS, IAS 3-SD, the IAS 3-SD adapter is necessary for connection to the machine, length 5 m, in carton	497215
IAS double adapter IAS 3-DA-CT	for LEX 3, LEX 2, LRS, CT extractor (not CT 11/MINI/MIDI), for simultaneously connecting two air tools with IAS 2 and/or IAS 3 adapter to a Festool dust extractor, Not suitable for M dust extractor, in carton	497284
Adapter AD-IAS/D 36	note: if IAS 2/IAS 3 hoses are used without this adapter to extract dirt directly, the hoses and air tools may be damaged by dirt deposits in connecting parts, for use with D 36 suction nozzles with IAS 2/IAS 3 hoses, in bag	488418
Adapter IAS-ZA	for central extraction units, boom arms manufactured by Rupes, IVO and Herkules, and Rupes power boxes, rubber bushing for connection of IAS 2/IAS 3 air tools via an IAS 2/IAS 3 connection, exterior Ø 59/75 mm, interior Ø 49/57 mm, in carton	489222
Connecting sleeve IAS 3-B1	for LEX 3, LEX 2, LRS, for connecting an IAS 3 or IAS 3 light hose to an SRM 70/SRM 312 B1 extractor, in self-service display pack	499024
Adapter IAS 3-FA	for LEX 3, LEX 2, LRS, for connecting an IAS 3 or IAS 3 light hose to an EAA power box or Herkules exhaust turbine, sleeve diameter 47,5 – 51,8 mm, in self-service display pack	499025
IAS adapter IAS-S-ZA/Herkules	for connection of IAS 2/IAS 3 suction hoses to Herkules central suction system, with closing slide, in carton	490605
Cleaning and lubricating oil LFC 9022/50	for LEX, LRS, special oil for compressed air preparation, 50 ml, in plastic bottle	201077
Cleaning and lubricating oil LFC 9022/1000	for LEX, LRS, special oil for compressed air preparation, in plastic bottle	201076



LRS 93



LRS 400

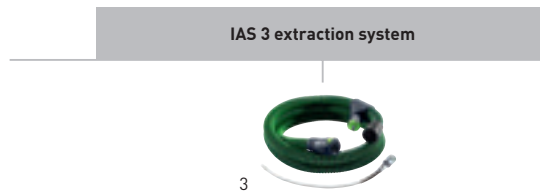

Accessories for compressed air orbital sanders LRS 93, LRS 400

Denomination	Explanation	Order no.
1 Sanding pad StickFix SSH-STF-93x175/8	for RS 300, RS 3, LRS 93, StickFix adhesive layer for quick change of sanding pad, width 175 mm, min. length 93 mm, dimensions 93 x 175 mm, in self-service display pack	483905
Sanding pad SSH-93x175/8	for RS 300, RS 3, LRS 93, for abrasives for clamping, width 175 mm, min. length 93 mm, dimensions 93 x 175 mm, in self-service display pack	489630
StickFix iron sanding pad SSH-STF-V93x266/14	for RS 300, RS 3, LRS 93, pressing iron sanding pad version, width 266 mm, min. length 93 mm, dimensions 93 x 266 mm, in self-service display pack	486418
Sanding pad SSH-STF-80x400/17	for LRS 400, HSK 80 x 400, HSK 80 x 200, soft, dimensions 80 x 400 mm, qty. in pack 1 piece(s), in self-service display pack	493140
2 Abrasives	from page 163	
3 IAS hoses IAS 3	from page 148	
IAS adapter IAS 3-SD	for LEX 3, LEX 2, LRS, for connecting a Festool compressed air sander directly to a compressed air line (without dust extraction), length 90 mm, in carton	497214
Compressed air hose D 12,4 x 5 m	for LEX 3, LEX 2, LRS, IAS 3-SD, the IAS 3-SD adapter is necessary for connection to the machine, length 5 m, in carton	497215
IAS double adapter IAS 3-DA-CT	for LEX 3, LEX 2, LRS, CT extractor (not CT 11/MINI/MIDI), for simultaneously connecting two air tools with IAS 2 and/or IAS 3 adapter to a Festool dust extractor, Not suitable for M dust extractor, in carton	497284
Adapter AD-IAS/D 36	note: if IAS 2/IAS 3 hoses are used without this adapter to extract dirt directly, the hoses and air tools may be damaged by dirt deposits in connecting parts, for use with D 36 suction nozzles with IAS 2/IAS 3 hoses, in bag	488418
Adapter IAS-ZA	for central extraction units, boom arms manufactured by Rupes, IVO and Herkules, and Rupes power boxes, rubber bushing for connection of IAS 2/IAS 3 air tools via an IAS 2/IAS 3 connection, exterior Ø 59/75 mm, interior Ø 49/57 mm, in carton	489222
Connecting sleeve IAS 3-B1	for LEX 3, LEX 2, LRS, for connecting an IAS 3 or IAS 3 light hose to an SRM 70/SRM 312 B1 extractor, in self-service display pack	499024
Adapter IAS 3-FA	for LEX 3, LEX 2, LRS, for connecting an IAS 3 or IAS 3 light hose to an EAA power box or Herkules exhaust turbine, sleeve diameter 47,5 – 51,8 mm, in self-service display pack	499025
IAS adapter IAS-S-ZA/Herkules	for connection of IAS 2/IAS 3 suction hoses to Herkules central suction system, with closing slide, in carton	490605
Cleaning and lubricating oil LFC 9022/50	for LEX, LRS, special oil for compressed air preparation, 50 ml, in plastic bottle	201077
Cleaning and lubricating oil LFC 9022/1000	for LEX, LRS, special oil for compressed air preparation, in plastic bottle	201076

Machining surfaces

System accessories

IAS 3 hoses

		Type	Order no.
	IAS hose for LEX 3, LEX 2, LRS, antistatic, in accordance with DIN IEC 312, bleeder resistor (DIN IEC 312) <1 mΩ/m, temperature-resistant up to + 70°C, hose dia. 44 mm, in carton		
	for connecting a Festool compressed air sander to a Festool mobile dust extractor or energy box, length 3,5 m	IAS 3-3500 AS	497208
	for connecting a Festool compressed air sander to a Festool mobile dust extractor or energy box, length 5 m	IAS 3-5000 AS	497209
	for connecting a Festool compressed air sander to a Festool mobile dust extractor or energy box, length 7 m	IAS 3-7000 AS	497210
	for connecting a Festool compressed air sander to a Festool energy box, length 10 m	IAS 3-10000 AS	497211
	IAS hose for LEX 3, LEX 2, LRS, antistatic, in accordance with DIN IEC 312, bleeder resistor (DIN IEC 312) <1 mΩ/m, temperature-resistant up to + 70°C, hose dia. 37 mm, in carton		
	for connecting a Festool compressed air sander to a Festool mobile dust extractor or energy box, length 3,5 m	IAS 3 light 3500 AS	497478
	for connecting a Festool compressed air sander to a Festool mobile dust extractor or energy box, length 5 m	IAS 3 light 5000 AS	497213
	for connecting a Festool compressed air sander to a Festool mobile dust extractor or energy box, length 7 m	IAS 3 light 7000 AS	497479
	note: not with combination of CT/SR and ASA, for connecting a Festool compressed air sander to a Festool energy box, length 10 m	IAS 3 light 10000 AS	497480

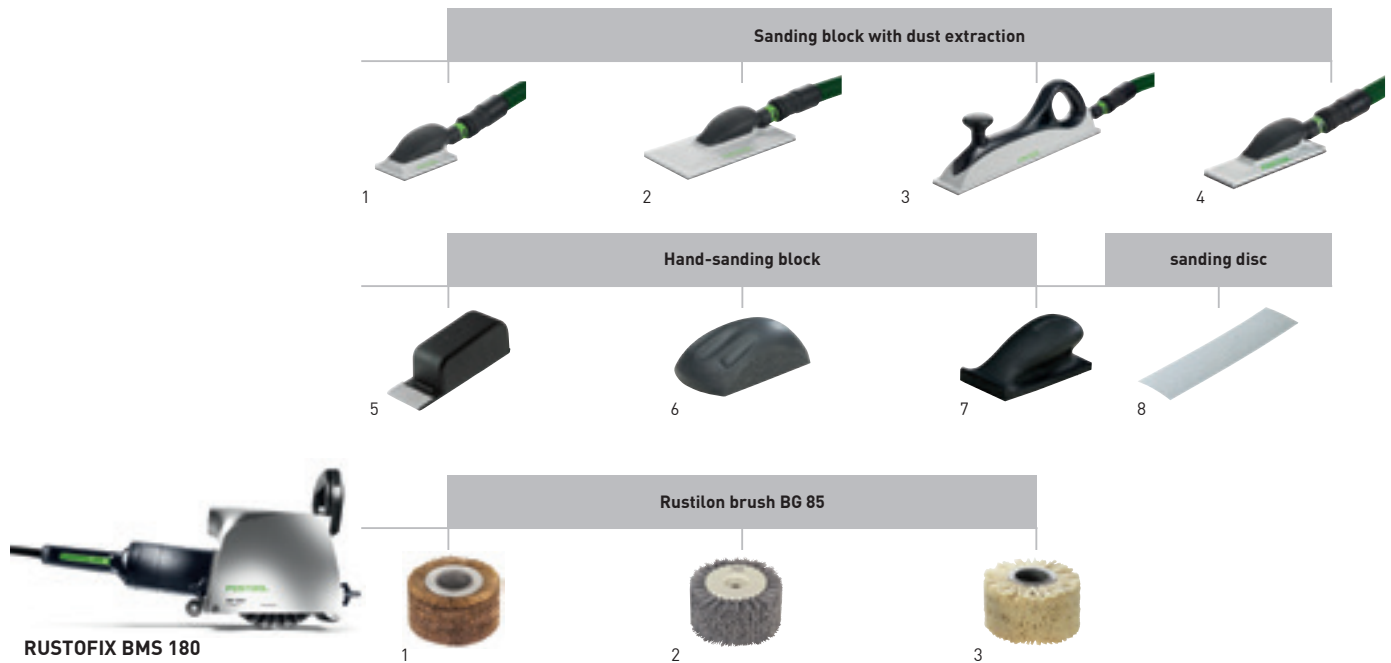

Accessories for manual sanding

Denomination	Explanation	Order no.
1 Sanding block HSK-A 80x130	compatible abrasive 80 x 133 mm, adapter for Festool hose, bypass adapter, weight 0,19 kg, in carton	496962
2 Sanding block HSK-A 115x226	compatible abrasive 115 x 228 mm, adapter for Festool hose, bypass adapter, weight 0,28 kg, in carton	496963
3 Sanding block HSK-A 80x400	compatible abrasive 80 x 400 mm, adapter for Festool hose, bypass adapter, weight 0,52 kg, in carton	496964
4 Sanding block HSK-A 80x200	compatible abrasive 80 x 400 mm (halved), adapter for Festool hose, bypass adapter, weight 0,2 kg, in carton	496965
Sanding block HSK-A-Set	compatible abrasive 80 x 133 mm, 115 x 228 mm, 80 x 400 mm, adapter for Festool hose, HSK-A 80x130, bypass adapter, HSK-A 80x200, HSK-A 80x400, HSK-A 115x226, in carton	497101
5 Hand-sanding block HSK-STF-46x178	for supporting StickFix, abrasive sheets 46 x 178 mm, in self-service display pack	583129
6 Sanding block HSK-D 150 W	soft, for attaching StickFix Ø 150 mm sanding discs, in self-service display pack	495965
Sanding block HSK-D 150 H	hard, for attaching StickFix Ø 150 mm sanding discs, in self-service display pack	495966
7 Sanding block HSK 80x133 H	hard, for attaching StickFix 80 x 133 mm abrasive sheets, in self-service display pack	495967
8 Abrasives	from page 166	

Accessories for RUSTOFIX BMS 180

Denomination	Explanation	Order no.
1 Rustilon brushes LD 85	for BMS 180, with standard steel wire, steel core, for texturing, exterior dia. 150 mm, width 85 mm, hole dia. 50 mm, in carton	411549
2 Rustilon brushes KB 85	for BMS 180, plastic bristles with embedded K80 grit, die-cast plastic core, for intermediate sanding, exterior dia. 150 mm, width 85 mm, hole dia. 16 – 30 mm, in carton	411969
3 Rustilon brushes BG 80	for BMS 180, with sisal bristles, steel core, for smoothing, exterior dia. 150 mm, width 80 mm, hole dia. 50 mm, in carton	411887

Machining surfaces

Abrasives

Impressive not just on paper, but also in the workshop.

You can rely on Festool for the right abrasive for every tool and every application. A single rule applies: the more compatible the abrasive and sanding pad are with the tool, the more efficient and economical the working results will be.

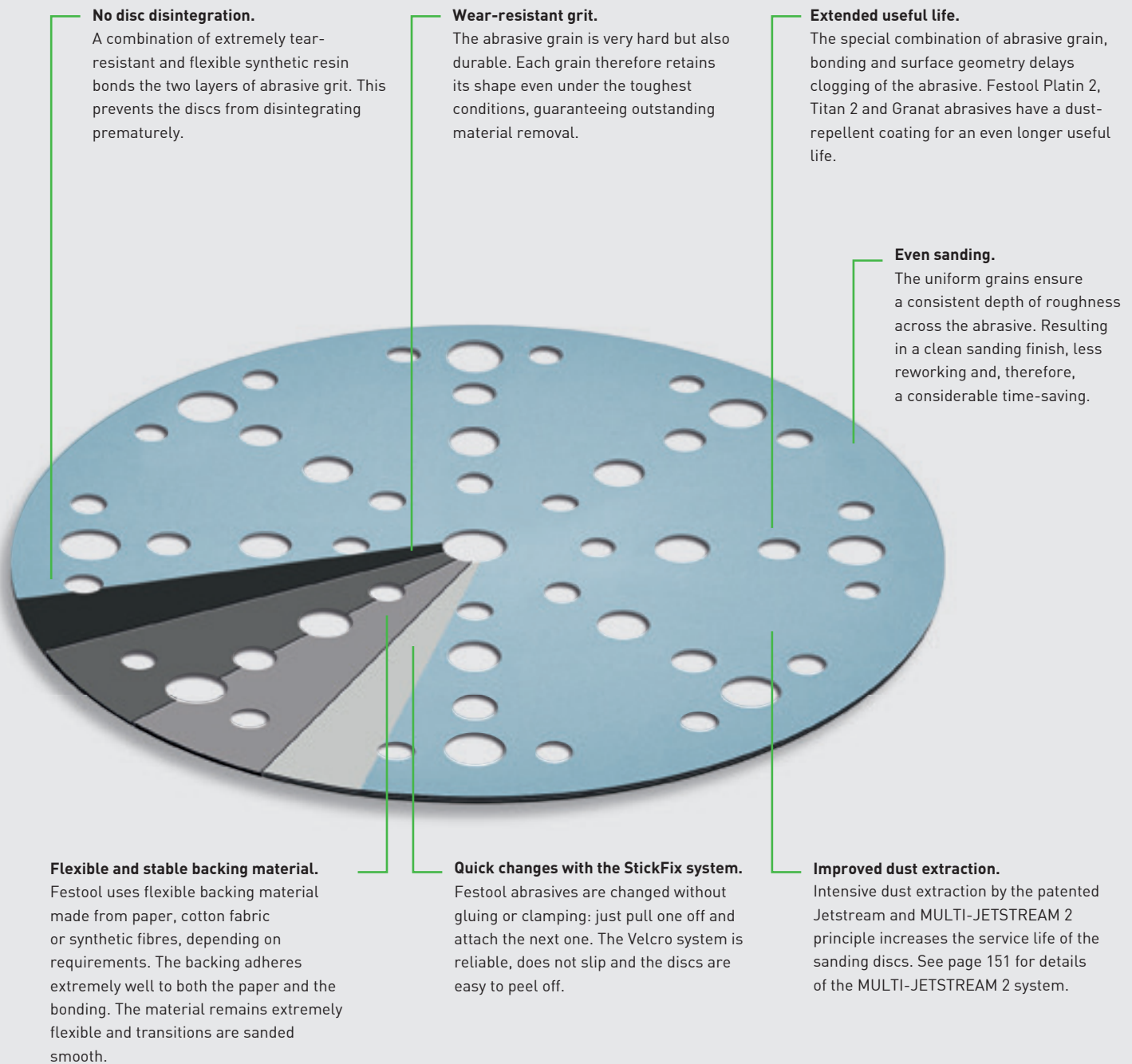

Achieving the perfect surface finish depends on the smallest of details. All Festool abrasives and sanding pads are adapted perfectly to the relevant sander as well as the overall system.

Abrasives

Granat

P40-3000

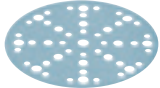

Universal for coarse to fine sanding

Sanding:

- Paint systems compliant with VOC regulations
- Water-dilutable clear coats
- Hard clear coats, undercoats such as GRP
- Also suitable for conventional clear coats, filler, paints

Granat Net

P40-220



Perfect for materials that produce a large quantity of dust

Sanding:

- Repair compound
- Filler
- Paint
- Clear coat
- Plaster filler and dispersion filler

Rubin 2

P40-220

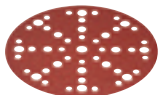

Perfect for processing wood

Sanding:

- Hardwood
- Softwood
- Wood composites
- Tropical wood

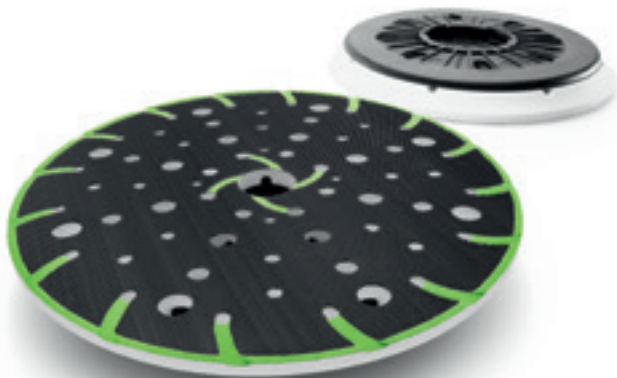

Economical working and faultless results guaranteed in all sanding applications.

Brilliant 2

P40-400

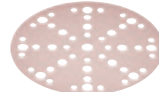

Universal for paints and clear coats.

Sanding:

- Acrylic and nitro-cellulose paint, priming varnish, DD lacquer
- Repair compound, fine and polyester filler
- Undercoats, fillers, protective paint, primers
- Preparation prior to priming wood (oil, wood stains)

Platin 2

S40-4000



For perfect preparation for polishing

Finishing/matting:

- High-gloss paints in preparation for polishing
- Water-dilutable clear coats
- Mineral materials, acrylic glass
- Plastics

Saphir

P24-80

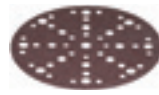

For efficient removal of wood and clear coats.

Coarse sanding:

- Hard subsurfaces, coatings, old clear coats
- Worn steps, roughly sawn wooden parts
- Deburring or rust removal
- Fibre-reinforced plastics

Vlies

100-1000



For light sanding, cleaning, oiling, waxing

Matting/light sanding of paints and clear coats:

- Lightly sanding old coats of paint before repainting
- Polishing metal
- Cleaning wood materials
- Oiling and waxing natural wood

With active dust conveying system – the patented MULTI-JETSTREAM 2 principle*

The MULTI-JETSTREAM 2 principle is defined by the unique interaction between intake air and exhaust air – with optimum dust extraction right up to the edge. An air flow is created which actively transports the sanding dust to the nearest extraction channel. The result: Virtually 100% dust extraction for a consistently high material removal rate, top surface quality and a healthy working environment.

Active dust conveying concept

The 48 suction holes collect the dust and transport it actively to the exhaust air channels. Dust is extracted from every point on the pad – right up to the edge.

Best extraction effect with maximum sanding performance

Effective dust extraction ensures that the fastener and abrasive remain dust-free for longer. The sanding effect remains high and the abrasive can therefore be used for longer.

Fastener resistant to high temperatures

On the MULTI-JETSTREAM 2 sanding pad, the fastener consists of material that is resistant to high temperatures and is therefore particularly durable. The special hooks in the fastener ensure perfect adhesion of the abrasive.

* For all sanding pads 150 mm in diameter

Machining surfaces

Abrasives

LEX 3 77

RO 90 DX



Dia. 77 mm

Granat



Grit	Qty. in pack	Order no.	Grit	Qty. in pack	Order no.
P80	50	497405	P400	50	497412
P120	50	497406	P500	50	497413
P150	50	497407	P800	50	498929
P180	50	497408	P1000	50	498930
P240	50	497409	P1200	50	498931
P280	50	497410	P1500	50	498932
P320	50	497411			

Ø 90 mm

Granat



P40	50	497363	P280	100	497850
P60	50	497364	P320	100	497372
P80	50	497365	P400	100	497373
P100	100	497366	P500	100	498326
P120	100	497367	P800	50	498327
P150	100	497368	P1000	50	498328
P180	100	497369	P1200	50	498329
P220	100	497370	P1500	50	498330
P240	100	497371			

Rubin 2



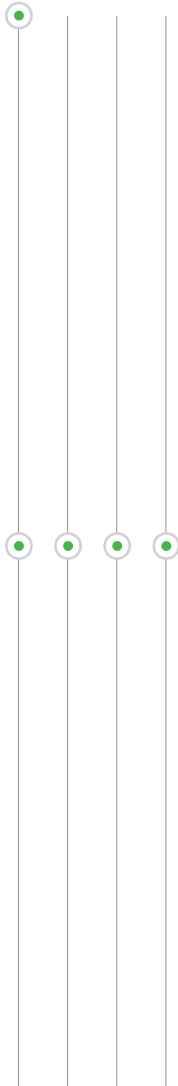

P40	50	499077	P120	50	499081
P60	50	499078	P150	50	499082
P80	50	499079	P180	50	499083
P100	50	499080	P220	50	499084

RO 90 DX
DX 93
RS 300
LRS 93



03

Ø 90 mm

	Grit	Qty. in pack	Order no.	Grit	Qty. in pack	Order no.
Brilliant 2 	P40	50	497379	P180	100	497385
	P60	50	497380	P220	100	497386
	P80	50	497381	P240	100	497387
	P100	100	497382	P320	100	497388
	P120	100	497383	P400	100	497389
	P150	100	497384			
Platin 2 	S500	15	498322	S2000	15	498324
	S1000	15	498323	S4000	15	498325



93V

Granat 	P40	50	497390	P180	100	497396
	P60	50	497391	P220	100	497397
	P80	50	497392	P240	100	497398
	P100	100	497393	P280	100	499644
	P120	100	497394	P320	100	497399
	P150	100	497395	P400	100	497400
Rubin 2 	P40	50	499161	P120	50	499165
	P60	50	499162	P150	50	499166
	P80	50	499163	P180	50	499167
	P100	50	499164	P220	50	499168

Machining surfaces

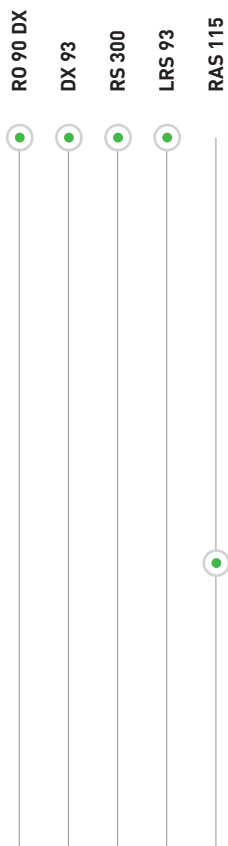
Abrasives



	Grit	Qty. in pack	Order no.	Grit	Qty. in pack	Order no.
93V						
Brilliant 2	P40	50	492883	P180	100	492889
	P60	50	492884	P220	100	492890
	P80	50	492885	P240	100	492891
	P100	100	492886	P320	100	492892
	P120	100	492887	P400	100	492893
	P150	100	492888			
Ø 115 mm						
Rubin 2	P40	50	499085	P100	50	499088
	P60	50	499086	P120	50	499089
	P80	50	499087			
Saphir	P24	25	484151	P50	25	485245
	P36	25	484152	P80	25	485246



RO 125
ETS 125
LEX 3 125



Dia. 125 mm

Granat



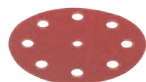



Grit	Qty. in pack	Order no.	Grit	Qty. in pack	Order no.	
P40	10	497145	P180	100	497171	
P60	10	497146	P220	100	497172	
P80	10	497147	P240	100	497173	
P120	10	497148	P280	100	497174	
P180	10	497149	P320	100	497175	
P320	10	497150	P360	100	497176	
P40	50	497165	P400	100	497177	
P60	50	497166	P500	100	497178	
P80	50	497167	P800	50	497179	
P100	100	497168	P1000	50	497180	
P120	100	497169	P1200	50	497181	
P150	100	497170	P1500	50	497182	
Granat Net	P80	50	203294	P220	50	203299
	P100	50	203295	P240	50	203300
	P120	50	203296	P320	50	203301
	P150	50	203297	P400	50	203302
	P180	50	203298			
Protection Pad	2	203344				
						
Rubin 2	P40	10	499101	P40	50	499093
	P60	10	499102	P60	50	499094
	P80	10	499103	P80	50	499095
	P100	10	499104	P100	50	499096
	P120	10	499105	P120	50	499097
	P150	10	499106	P150	50	499098
	P180	10	499107	P180	50	499099
	P220	10	499108	P220	50	499100

Machining surfaces

Abrasives

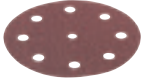

	Grit	Qty. in pack	Order no.	Grit	Qty. in pack	Order no.
Ø 125 mm						
Brilliant 2 	P40	10	495989	P80	50	492945
	P60	10	495990	P100	100	492946
	P80	10	495991	P120	100	492947
	P120	10	495992	P150	100	492948
	P180	10	495993	P180	100	492949
	P320	10	495994	P220	100	492950
	P40	50	493657	P320	100	492951
	P60	50	492944	P400	100	492952
	Platin 2 	S400	15	492373	S2000	15
S500		15	492374	S4000	15	492377
S1000		15	492375			
Saphir 	P24	25	493124	P50	25	493126
	P36	25	493125	P80	25	493127
Vlies 	100	10	201131	green	10	496510
	320	10	201132	white	10	496511
	800	10	201133			

RO 150
ETS 150
LEX 3 150



Ø 150 mm

Granat

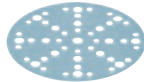

Grit	Qty. in pack	Order no.	Grit	Qty. in pack	Order no.
P40	10	575154	P180	100	575166
P60	10	575155	P220	100	575167
P80	10	575156	P240	100	575168
P120	10	575157	P280	100	575169
P180	10	575158	P320	100	575170
P320	10	575159	P360	100	575171
P40	50	575160	P400	100	575172
P60	50	575161	P500	100	575173
P80	50	575162	P800	50	575174
P100	100	575163	P1000	50	575175
P120	100	575164	P1200	50	575176
P150	100	575165	P1500	50	575177

Granat Net



P80	50	203303	P220	50	203308
P100	50	203304	P240	50	203309
P120	50	203305	P320	50	203310
P150	50	203306	P400	50	203311
P180	50	203307			

Protection Pad

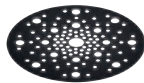

	2	203343			
--	---	--------	--	--	--

Rubin 2

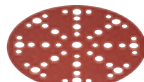





P40	10	575178	P40	50	575186
P60	10	575179	P60	50	575187
P80	10	575180	P80	50	575188
P100	10	575181	P100	50	575189
P120	10	575182	P120	50	575190
P150	10	575183	P150	50	575191
P180	10	575184	P180	50	575192
P220	10	575185	P220	50	575193

Machining surfaces

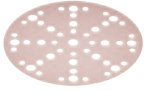
Abrasives



	Grit	Qty. in pack	Order no.	Grit	Qty. in pack	Order no.
Ø 150 mm						
Brilliant 2	P40	10	575137	P100	100	575146
	P60	10	575138	P120	100	575147
	P80	10	575139	P150	100	575148
	P120	10	575140	P180	100	575149
	P180	10	575141	P220	100	575150
	P320	10	575142	P240	100	575151
	P40	50	575143	P320	100	575152
	P60	50	575144	P400	100	575153
	P80	50	575145			
Platin 2	S400	15	492368	S2000	15	492371
	S500	15	492369	S4000	15	492372
	S1000	15	492370			
Saphir	P24	25	575194	P50	25	575196
	P36	25	575195	P80	25	575197
Vlies	100	10	201126	green	10	496508
	320	10	201127	white	10	496509
	800	10	201128			

RAS 180
LEX 2 185/7
LHS 225

Ø 180 mm

Rubin 2



Grit	Qty. in pack	Order no.	Grit	Qty. in pack	Order no.
P40	50	499125	P120	50	499129
P60	50	499126	P150	50	499130
P80	50	499127	P180	50	499131
P100	50	499128	P220	50	499132

Saphir



P24	25	485239	P50	25	485241
P36	25	485240	P80	25	485242

Ø 185 mm

Granat

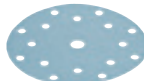

P40	50	497183	P150	100	497187
P60	50	497184	P180	100	497188
P80	50	497185	P240	100	497189
P100	100	499629	P320	100	497190
P120	100	497186	P400	100	497191

Ø 225 mm

Granat

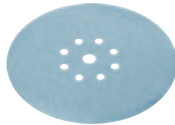

P40	25	499634	P150	25	499639
P60	25	499635	P180	25	499640
P80	25	499636	P220	25	499641
P100	25	499637	P240	25	499642
P120	25	499638	P320	25	499643

Granat Net

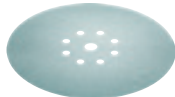

P80	25	203312	P180	25	203316
P100	25	203313	P220	25	203317
P120	25	203314	P240	25	203318
P150	25	203315	P320	25	203319

Machining surfaces

Abrasives

LHS 225
 RTS 400
 LS 130
 HSK-A 80x130



Ø 225 mm

Brilliant 2



Grit	Qty. in pack	Order no.	Grit	Qty. in pack	Order no.
P16	25	495925	P120	25	495931
P24	25	495926	P150	25	495066
P40	25	495927	P180	25	495067
P60	25	495928	P220	25	495068
P80	25	495929	P240	25	495932
P100	25	495930	P320	25	495933

Saphir

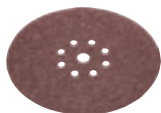

P24	25	495174	P36	25	495175
-----	----	--------	-----	----	--------

80 x 133 mm

Granat



P40	10	497127	P120	100	497120
P80	10	497128	P150	100	497121
P120	10	497129	P180	100	497122
P180	10	497130	P220	100	497123
P40	50	497117	P240	100	497124
P60	50	497118	P280	100	497204
P80	50	497119	P320	100	497125
P100	100	499628	P400	100	497126

Granat Net

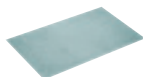

P80	50	203285	P220	50	203290
P100	50	203286	P240	50	203291
P120	50	203287	P320	50	203292
P150	50	203288	P400	50	203293
P180	50	203289			

Protection Pad



	2	203346			
--	---	--------	--	--	--

RTS 400
 LS 130
 HSK-A 80x130
 LRS 400
 HSK-A 80 x 400/80 x 200

80 x 133 mm

Rubin 2

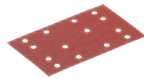

Grit	Qty. in pack	Order no.	Grit	Qty. in pack	Order no.
P40	10	499054	P40	50	499046
P60	10	499055	P60	50	499047
P80	10	499056	P80	50	499048
P100	10	499057	P100	50	499049
P120	10	499058	P120	50	499050
P150	10	499059	P150	50	499051
P180	10	499060	P180	50	499052
P220	10	499061	P220	50	499053

Brilliant 2



P40	10	492859	P100	100	492851
P60	10	496008	P120	100	492852
P80	10	492860	P150	100	492853
P120	10	492861	P180	100	492854
P180	10	492862	P220	100	492855
P40	50	492848	P240	100	492856
P60	50	492849	P320	100	492857
P80	50	492850	P400	100	492858

Vlies



800	5	483582
-----	---	--------

80 x 400 mm

Granat

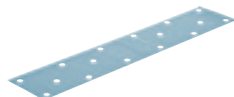

P40	50	497157	P150	50	497161
P60	50	497158	P180	50	497162
P80	50	497159	P240	50	497163
P100	50	499631	P280	50	497203
P120	50	497160	P320	50	497164

Machining surfaces

Abrasives

DTS 400 R



100 x 150 mm

Granat



Grit	Qty. in pack	Order no.	Grit	Qty. in pack	Order no.
P40	10	497131	P120	100	497138
P80	10	497132	P150	100	497139
P120	10	497133	P180	100	497140
P180	10	497134	P220	100	497141
P40	50	497135	P240	100	497142
P60	50	497136	P320	100	497143
P80	50	497137	P400	100	497144
P100	100	499630			

Granat Net



P80	50	203320	P220	50	203325
P100	50	203321	P240	50	203326
P120	50	203322	P320	50	203327
P150	50	203323	P400	50	203328
P180	50	203324			

Protection Pad



	2	203347			
--	---	--------	--	--	--

Rubin 2



P40	10	499141	P40	50	499133
P60	10	499142	P60	50	499134
P80	10	499143	P80	50	499135
P100	10	499144	P100	50	499136
P120	10	499145	P120	50	499137
P150	10	499146	P150	50	499138
P180	10	499147	P180	50	499139
P220	10	499148	P220	50	499140

DTS 400 R

RS 300

RS 3

LRS 93



100 x 150 mm

Brilliant 2



Grit	Qty. in pack	Order no.	Grit	Qty. in pack	Order no.
P40	10	492804	P100	100	492796
P60	10	496010	P120	100	492797
P80	10	492805	P150	100	492798
P120	10	492806	P180	100	492799
P180	10	492807	P220	100	492800
P40	50	492793	P240	100	492801
P60	50	492794	P320	100	492802
P80	50	492795	P400	100	492803

93 x 178 mm

Granat

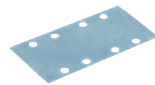

P40	50	498933	P180	100	498938
P60	50	498934	P220	100	498939
P80	50	498935	P240	100	498940
P100	100	499633	P280	100	498941
P120	100	498936	P320	100	498942
P150	100	498937	P400	100	498943

Rubin 2



P40	50	499185	P120	50	499065
P60	50	499062	P150	50	499066
P80	50	499063	P180	50	499067
P100	50	499064	P220	50	499068

Brilliant 2



P40	50	492911	P180	100	492917
P60	50	492912	P220	100	492918
P80	50	492913	P240	100	492919
P100	100	492914	P320	100	492920
P120	100	492915	P400	100	492921
P150	100	492916			

Machining surfaces

Abrasives



	Grit	Qty. in pack	Order no.	Grit	Qty. in pack	Order no.
115 x 228 mm						
Granat 	P40	50	498944	P180	100	498949
	P60	50	498945	P220	100	498950
	P80	50	498946	P240	100	498951
	P100	100	499632	P280	100	498952
	P120	100	498947	P320	100	498953
	P150	100	498948	P400	100	498954
Brilliant 2 	P40	50	492822	P180	100	492828
	P60	50	492823	P220	100	492829
	P80	50	492824	P240	100	492830
	P100	100	492825	P320	100	492831
	P120	100	492826	P400	100	492832
	P150	100	492827			
Rubin 2 	P40	50	499030	P120	50	499034
	P60	50	499031	P150	50	499035
	P80	50	499032	P180	50	499036
	P100	50	499033	P220	50	499037

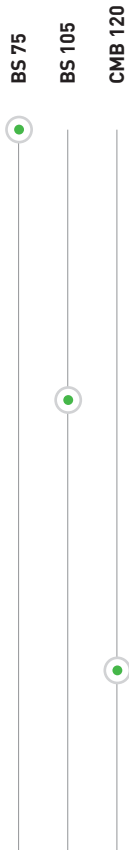

533 x 75 mm

	Grit	Qty. in pack	Order no.	Grit	Qty. in pack	Order no.
	Rubin 2					
	P40	10	499155	P100	10	499158
	P60	10	499156	P120	10	499159
	P80	10	499157	P150	10	499160

620 x 105 mm

	Grit	Qty. in pack	Order no.	Grit	Qty. in pack	Order no.
	Rubin 2					
	P40	10	499149	P100	10	499152
	P60	10	499150	P120	10	499153
	P80	10	499151	P150	10	499154

820 x 120 mm

	Grit	Qty. in pack	Order no.	Grit	Qty. in pack	Order no.
	Saphir					
	P50	10	488081	P120	10	488084
	P80	10	488082	P150	10	488085
	P100	10	488083	P180	10	488086

Machining surfaces

Abrasives

	Grit	Qty. in pack	Order no.	Grit	Qty. in pack	Order no.
Pocket StickFix 46 x 178 mm for hand sanding block						
	P40	10	492843	P120	10	492845
	P80	10	492844	P180	10	492846

	Grit	Qty. in pack	Order no.	Grit	Qty. in pack	Order no.
Self-adhesive sanding discs Ø 36 mm						
	P2000	500	500445	P3000	500	500447
	P2500	500	500446			

	Grit	Qty. in pack	Order no.	Grit	Qty. in pack	Order no.
Hand abrasive Granat soft 115 mm x 25 m						
	P120	1	497091	P400	1	497096
	P150	1	497092	P500	1	497097
	P180	1	497093	P600	1	497098
	P240	1	497094	P800	1	497964
	P320	1	497095			

	Grit	Qty. in pack	Order no.	Grit	Qty. in pack	Order no.
Hand abrasive Granat abrasive roll 115 mm x 25 m						
	P40	1	201103	P150	1	201108
	P60	1	201104	P180	1	201109
	P80	1	201105	P220	1	201110
	P100	1	201106	P240	1	201111
	P120	1	201107	P320	1	201768

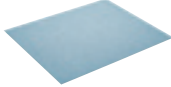
	Grit	Qty. in pack	Order no.	Grit	Qty. in pack	Order no.	
Hand abrasive Granat sandpaper 230 x 280 mm							
	Granat	P40	10	201256	P40	25	201085
		P60	10	201257	P60	50	201087
		P80	10	201258	P80	50	201088
		P100	10	201259	P100	50	201089
		P120	10	201260	P120	50	201090
		P150	10	201261	P150	50	201091
		P180	10	201262	P180	50	201093
		P220	10	201263	P220	50	201094
		P240	10	201264	P240	50	201095
		P320	10	201265	P320	50	201096
	P400	10	201266	P400	50	201097	

Granat sanding block manual abrasive 69 x 98 x 26 mm (four-sided)							
	Granat	36	6	201080	120	6	201082
		60	6	201081	220	6	201083

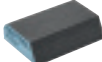
Granat sanding block manual abrasive 69 x 98 x 26 mm (four-sided) combi block							
	Granat	120	6	201084			

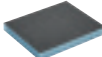
Hand abrasive Granat abrasive sponge 98 x 120 x 13 mm (2-sided)							
	Granat	60	6	201112	220	6	201114
		120	6	201113	800	6	201507

Granat abrasive pad manual abrasive 115 x 140 x 5 mm (one-sided)							
	Granat	280	20	201769	1000	20	201101
		500	20	201099	1500	20	201102
		800	20	201100			

Hand abrasive Vlies 115 x 152 mm							
	Vlies	100	25	201115	800	30	497089
		320	30	497088	1000	30	497090

Hand abrasive Vlies abrasive roll 115 mm x 10 m							
	Vlies	100	1	201116	800	1	201118
		320	1	201117	1000	1	201119

Machining surfaces

Polishing system overview

Preparing the surface



Denibber



Spot sander



Self-adhesive sanding disc

Fine sanding



Sander ETS 150/3



Sanding pad Ø 150 mm

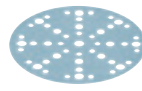

Granat P 1500 abrasive
dia. 150 mm

Polishing



Polisher SHINEX RAP 150



Polisher POLLUX 180



Polishing pad
dia. 150 mm
dia. 180 mm

Orange – Preliminary polishing



Orange polishing pad (medium)
Premium sheepskin

MPA 5010 polish

Blue – fine polishing

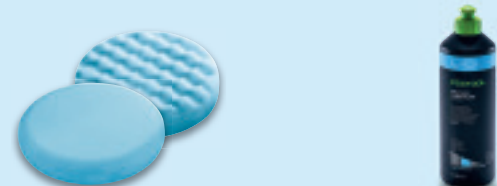

Blue polishing pad (medium-fine)

MPA 9010 polish

Polishing out swirl marks



Geared eccentric sanders
ROTEX RO 150
ROTEX RO 125
ROTEX RO 90 DX



Polishing pad
Ø 150 mm
Ø 125 mm
Ø 90 mm

White high gloss polishing

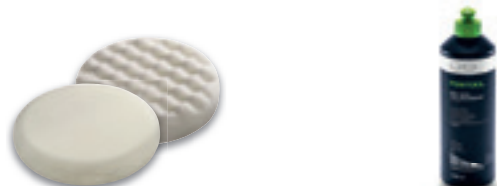

White polishing pad (fine)

MPA 11010 polish

Cleaning/finish



MPA F+ finish cleaner



MPA SV+ spray sealant



MPA Microfibre cloth



RT PREMIUM cleaning cloth

**Leave behind a brilliant impression.
Festool polishes and polishing sponges.**

Polish with ease and achieve brilliant results – Festool polishes are specially designed for their various applications. These polishes are water-based and do not contain silicone, and when used in combination with the appropriate polishing pad, they ensure reliable and optimal results for all types of paint while requiring minimal effort. The clearly organised colour coding system enables users to quickly find the appropriate product.

Polish



<p>MPA 5010</p> <p>Speed Cut 1-step sanding polish</p> <p>High sanding performance and a high gloss finish in a single step</p>	<p>MPA 9010</p> <p>Fine sanding polish</p> <p>Fine sanding performance for intermediate and fine polishing</p>	<p>MPA 11010</p> <p>anti-swirl-mark high-gloss polish</p> <p>Extra fine sanding performance for removing microscratches and swirl marks</p>
---	--	---

Foam polishing pads



Coarse
for polishing heavily weathered surfaces (preparation for painting)

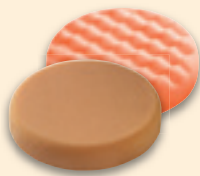

Mid
For polishing and removing imperfections in paintwork. Ideal together with the MPA 5010.



medium-fine
For removing microscratches in paintwork. Ideal together with the MPA 9010.



Fine
For polishing out swirl marks and producing a deep shine. Ideal together with the MPA 11010.



Very fine
For removing polish residues on the painted surface.

Polishing felt and sheepskin pad



Hard polishing felt
For preliminary polishing of mineral materials, acrylic glass and clear coats

Soft polishing felt
For follow-up polishing of mineral materials, acrylic glass and clear coats



Premium sheepskin
Particularly suitable for UV clear coats, scratch-resistant clear coats

Finish cleaner and spray sealant

The high-quality microfibre cloths have a scratch-free edge to ensure a perfect finish for paint. They are perfectly suited to removing polish residue and grease spots when used in conjunction with finish cleaner.

The spray sealant is suitable for quickly and easily sealing painted surfaces, conserving, protecting and maintaining the paint.



Machining surfaces



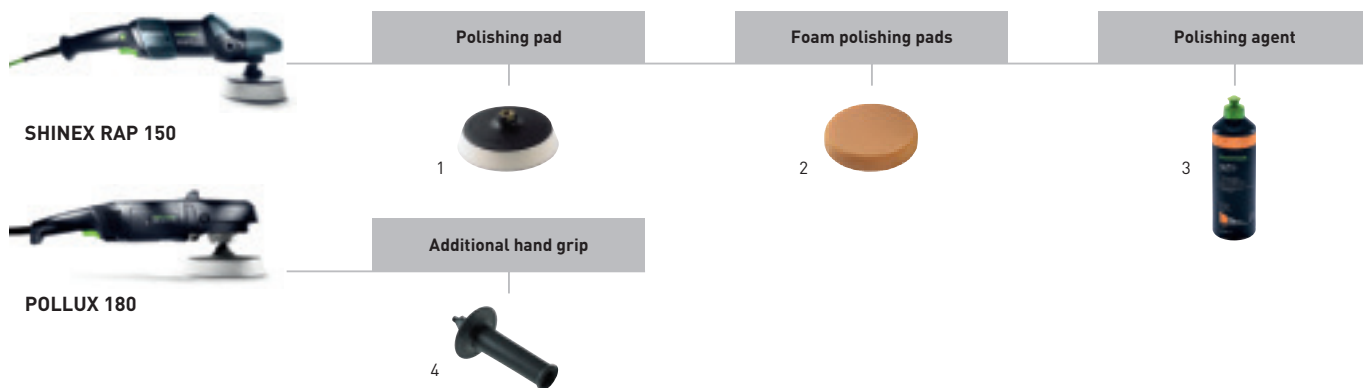

System accessories





Accessories for SHINEX RAP 150, POLLUX 180 rotary polishers

Denomination	Explanation	Order no.
1 Polishing pad PT-STF-D150-M14	for RAP 150, with integrated shock absorber for optimum distribution of pressure during polishing, fits polishing accessories, diameter 125 mm, height 25 mm, in self-service display pack	488342
Polishing pad PT-STF-D180-M14	for RAP 180, with integrated shock absorber for optimum distribution of pressure during polishing, fits polishing accessories, diameter 165 mm, height 30 mm, in self-service display pack	488349
2 Foam polishing pads	from page 175	
3 Polishing agent	from page 171	
4 Additional hand grip ZG-RAS/RO	for RO 150, RAS, WTS 150, in carton	487865

Polishing agent

		Type	Order no.
	Polishing agent Speed Cut 1-step sanding polish, does not contain silicone, water-based, perfect in combination with a sheepskin pad or polishing pad (ORANGE), volume 500 ml, in plastic bottle	MPA 5010 OR/0,5L	202048
	Polishing agent Speed Gloss fine sanding polish, does not contain silicone, water-based, perfect in combination with a polishing pad (BLUE), volume 500 ml, in plastic bottle	MPA 9010 BL/0,5L	202050
	Polishing agent anti-swirl-mark high-gloss polish, does not contain silicone, water-based, perfect in combination with a polishing pad (WHITE), volume 500 ml, in plastic bottle	MPA 11010 WH/0,5L	202051
	Sealing spray for sealing painted surfaces, does not contain silicone, water-based, volume 500 ml, in plastic bottle	MPA SV+/0,5L	202052
	Finish-Cleaner for removing polish residues and grease marks, does not contain silicone, water-based, volume 500 ml, in plastic bottle	MPA F+/0,5L	202053



Microfibre cloth, cleaning cloth

		Type	Order no.
	Microfibre cloth for excellent finish of new paints, for removing polish residues and grease marks, qty. in pack 2 piece(s), in self-service display pack	MPA-Microfibre/2	493068
	Cleaning cloth roller with 200 sheets, fibre-reinforced, tear-proof and extremely absorbent, in dispenser box, in carton	RT PREMIUM 240x380/200	498071

Machining surfaces

Polishing accessories

Self-adhesive sanding discs, spot sander and spot repair scraper

		Type	Order no.
	Self-adhesive sanding disc for spot sander RH-SK D 32-36, self-adhesive, in a roll, Granat version, qty. in pack 500 piece(s), in bag		
	grit P2000	SK D32-36/0 P2000 GR/500	500445
	grit P2500	SK D32-36/0 P2500 GR/500	500446
	grit P3000	SK D32-36/0 P3000 GR/500	500447
	Spot sander for self-adhesive sanding discs D 32-36, used for holding self-adhesive sanding discs with diameter of 36 mm, for eliminating flaws, in bag	RH-SK D32-36	493069
	Spot repair scraper with cord, for the accurate removal of trapped particles and unevenness, manufactured from carbide, with hollow grinding, dimensions 25 x 30 mm, in self-service display pack	LZK-HM	497525

RAP 80, T 15+3, T 18+3

RO 90 DX



PoliStick polishing sponge for dia. 80 mm

		Diameter	Height in mm	Qty. in pack	Order no.
	yellow, Coarse, for polishing heavily weathered surfaces (preparation for painting)	80 mm	20 mm	5	201989
	orange, Mid, for preliminary polishing when repairing paint flaws, ideal together with the MPA 5010	80 mm	20 mm	5	201993
	orange, medium (waffle face), for preliminary polishing when repairing paint flaws, ideal together with the MPA 5010	80 mm	20 mm	5	201994
	blue, medium-fine, for removing microscratches in clear coats, ideal together with the MPA 9010	80 mm	20 mm	5	202001
	blue, medium-fine (waffle face), for removing microscratches in clear coats, ideal together with the MPA 9010	80 mm	20 mm	5	202002
	white, Fine, for polishing out swirl marks and producing a deep shine, for high-gloss polish (deep shine), ideal together with the MPA 11010	80 mm	20 mm	5	202009
	white, fine (honeycombed), for polishing out swirl marks and producing a deep shine, for high-gloss polish (deep shine), ideal together with the MPA 11010	80 mm	20 mm	5	202010
	black, very fine (honeycombed), for removing polish residues on the painted surface	80 mm	20 mm	5	202017

Sheepskin and polishing felt for dia. 80 mm

	real hair sheepskin for high abrasiveness and an excellent polishing finish, ideal together with the MPA 5010, Suitable for UV paints, scratch-resistant paints, optimum adhesion thanks to full covering with adhesive velour and edge seams	80 mm	18 mm	5	202044
	Polishing felt, hard, For preliminary polishing of mineral materials, acrylic glass and gloss paints, white	80 mm	6 mm	5	488339
	Polishing felt, soft, for re-polishing mineral materials, acrylic glass and gloss paints, white	80 mm	6 mm	5	488341

Machining surfaces

Polishing accessories

RO 125



		Diameter	Height in mm	Qty. in pack	Order no.
PoliStick polishing sponge for dia. 125 mm					
	yellow, Coarse, for polishing heavily weathered surfaces (preparation for painting)	125 mm	20 mm	5	201990
	orange, Mid, for preliminary polishing when repairing paint flaws, ideal together with the MPA 5010	125 mm	20 mm	1	202367
		125 mm	20 mm	5	201995
	orange, medium (waffle face), for preliminary polishing when repairing paint flaws, ideal together with the MPA 5010	125 mm	20 mm	1	202368
		125 mm	20 mm	5	201996
	blue, medium-fine, for removing microscratches in clear coats, ideal together with the MPA 9010	125 mm	20 mm	1	202371
		125 mm	20 mm	5	202003
	blue, medium-fine (waffle face), for removing microscratches in clear coats, ideal together with the MPA 9010	125 mm	20 mm	1	202372
		125 mm	20 mm	5	202004
	white, Fine, for polishing out swirl marks and producing a deep shine, for high-gloss polish (deep shine), ideal together with the MPA 11010	125 mm	20 mm	1	202375
		125 mm	20 mm	5	202011
	white, fine (honeycombed), for polishing out swirl marks and producing a deep shine, for high-gloss polish (deep shine), ideal together with the MPA 11010	125 mm	20 mm	1	202376
		125 mm	20 mm	5	202012
	black, very fine (honeycombed), for removing polish residues on the painted surface	125 mm	20 mm	1	202379
		125 mm	20 mm	5	202018
Sheepskin and polishing felt for dia. 125 mm					
	real hair sheepskin for high abrasiveness and an excellent polishing finish, ideal together with the MPA 5010, Suitable for UV paints, scratch-resistant paints, optimum adhesion thanks to full covering with adhesive velour and edge seams	125 mm	18 mm	1	202045
	Polishing felt, hard, For preliminary polishing of mineral materials, acrylic glass and gloss paints, white	125 mm	6 mm	5	493078
	Polishing felt, soft, For re-polishing mineral materials, acrylic glass and gloss paints, white	125 mm	6 mm	5	493077

RAP 150



RO 150



PoliStick polishing sponge for dia. 150 mm

		Diameter	Height in mm	Qty. in pack	Order no.
	yellow, Coarse, for polishing heavily weathered surfaces (preparation for painting)	150 mm	30 mm	5	201991
	orange, Mid, for preliminary polishing when repairing paint flaws, ideal together with the MPA 5010	150 mm	30 mm	1	202369
		150 mm	30 mm	5	201997
	orange, medium (waffle face), for preliminary polishing when repairing paint flaws, ideal together with the MPA 5010	150 mm	30 mm	1	202370
		150 mm	30 mm	5	201998
	blue, medium-fine, for removing microscratches in clear coats, ideal together with the MPA 9010	150 mm	30 mm	1	202373
		150 mm	30 mm	5	202005
	blue, medium-fine (waffle face), for removing microscratches in clear coats, ideal together with the MPA 9010	150 mm	30 mm	1	202374
		150 mm	30 mm	5	202006
	white, Fine, for polishing out swirl marks and producing a deep shine, for high-gloss polish (deep shine), ideal together with the MPA 11010	150 mm	30 mm	1	202377
		150 mm	30 mm	5	202013
	white, fine (honeycombed), for polishing out swirl marks and producing a deep shine, for high-gloss polish (deep shine), ideal together with the MPA 11010	150 mm	30 mm	1	202378
		150 mm	30 mm	5	202014
	black, very fine (honeycombed), for removing polish residues on the painted surface	150 mm	30 mm	1	202380
		150 mm	30 mm	5	202019

Sheepskin and polishing felt for dia. 150 mm

	real hair sheepskin for high abrasiveness and an excellent polishing finish, ideal together with the MPA 5010, Suitable for UV paints, scratch-resistant paints, optimum adhesion thanks to full covering with adhesive velour and edge seams	150 mm	18 mm	1	202046
	Polishing felt, hard, For preliminary polishing of mineral materials, acrylic glass and gloss paints, white	150 mm	6 mm	1	485970
		150 mm	6 mm	5	488348
	Polishing felt, soft, For re-polishing mineral materials, acrylic glass and gloss paints, white	150 mm	6 mm	1	485972
		150 mm	6 mm	5	488347

Machining surfaces

Polishing accessories

POLLUX 180

RAP 180



PoliStick polishing sponge for dia. 180 mm



yellow, Coarse, for polishing heavily weathered surfaces (preparation for painting)

Diameter

Height in mm

Qty. in pack

Order no.

180 mm

30 mm

5

201992



orange, Mid, for preliminary polishing when repairing paint flaws, ideal together with the MPA 5010

180 mm

30 mm

5

201999



orange, medium (waffle face), for preliminary polishing when repairing paint flaws, ideal together with the MPA 5010

180 mm

30 mm

5

202000



blue, medium-fine, for removing microscratches in clear coats, ideal together with the MPA 9010

180 mm

30 mm

5

202007

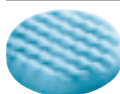

blue, medium-fine (waffle face), for removing microscratches in clear coats, ideal together with the MPA 9010

180 mm

30 mm

5

202008



white, Fine, for polishing out swirl marks and producing a deep shine, for high-gloss polish (deep shine), ideal together with the MPA 11010

180 mm

30 mm

5

202015



white, fine (honeycombed), for polishing out swirl marks and producing a deep shine, for high-gloss polish (deep shine), ideal together with the MPA 11010

180 mm

30 mm

5

202016



black, very fine (honeycombed), for removing polish residues on the painted surface

180 mm

30 mm

5

202020

Sheepskin and polishing felt for dia. 180 mm



real hair sheepskin for high abrasiveness and an excellent polishing finish, ideal together with the MPA 5010, Suitable for UV paints, scratch-resistant paints, optimum adhesion thanks to full covering with adhesive velour and edge seams

180 mm

18 mm

1

202047



Polishing felt, hard, For preliminary polishing of mineral materials, acrylic glass and gloss paints, white

180 mm

6 mm

5

488355



Polishing felt, soft, for re-polishing mineral materials, acrylic glass and gloss paints, white

180 mm

6 mm

5

488354

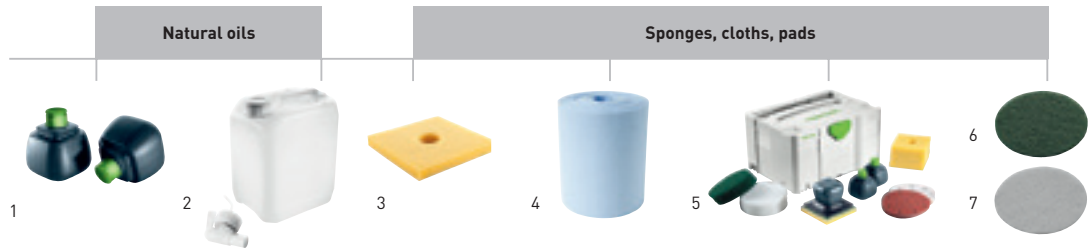

Accessories for SURFIX OS oil dispenser

Denomination	Explanation	Order no.
1 Natural oil RF HD 0,3 l/2	heavy-duty oil, refill bottle, volume 300 ml, qty. in pack 2 piece(s), in self-service display pack	498064
Natural oil RF OS 0,3 l/2	one-step oil, refill bottle, volume 300 ml, qty. in pack 2 piece(s), in self-service display pack	498065
Natural oil RF OD 0,3 l/2	outdoor oil, refill bottle, volume 300 ml, qty. in pack 2 piece(s), in self-service display pack	498066
2 Natural oil RF HD 5l	heavy-duty oil, filling quantity 5 l, in canister	498067
Natural oil RF OS 5l	one-step oil, filling quantity 5 l, in canister	498068
Natural oil RF OD 5l	outdoor oil, filling quantity 5 l, in canister	498069
3 Oil sponge OS-STF 125x125/5	StickFix sponge for SURFIX oil dispenser, qty. in pack 5 piece(s), dimensions 125 x 125 mm, in carton	498070
4 Cleaning cloth RT PREMIUM 240x380/200	roller with 200 sheets, fibre-reinforced, tear-proof and extremely absorbent, in dispenser box, in carton	498071
5 Oil dispenser OS-SYS3-Set	base plate, heavy-duty oil bottle, 0.3 l, one-step oil bottle, 0.3 l, outdoor oil bottle, 0.3 l, 5 x StickFix oil sponge, 5 x green non-woven sanding pad, 5 x white non-woven sanding pad, 10 x sanding discs STF-D150 P180 RU2, 10 x sanding discs STF-D150 P240 BR2, in SYSTAINER SYS 3 T-LOC	498063
6 Sanding vlies STF D125 green VL/10	Oil worked into the surface deep and evenly, grit green, qty. in pack 10 piece(s), diameter 125 mm, in carton	496510
Sanding vlies STF D150 green VL/10	Oil worked into the surface deep and evenly, grit green, qty. in pack 10 piece(s), diameter 150 mm, in carton	496508
7 Polishing fleece STF D125 white VL/10	Even distribution and polishing of oil and wax for further surface refinement, Non-abrasive polishing without grit, grit white, qty. in pack 10 piece(s), diameter 125 mm, in carton	496511
Polishing fleece STF D150 white VL/10	Even distribution and polishing of oil and wax for further surface refinement, Non-abrasive polishing without grit, grit white, qty. in pack 10 piece(s), diameter 150 mm, in carton	496509



Dust extraction

Overview of products and applications 180

Mobile dust extractors

CLEANTEC compact CT 17, CTL SYS, CTL MINI, CTL MIDI 186

CLEANTEC CT 26/36/48 190

CLEANTEC AUTOCLEAN CT 26/36/48 AC, CT 36 AC PLANEX,
CT 26/36 AC HD 192

Special extractors

CLEANTEC CT 48 EC, CT 48 EC/B22, CTH 26/48 195

Accessories and consumable materials 198

The Festool system

Dust extraction

Overview of products and applications

Compact yet effective. Lightweight yet powerful. Whether on the construction site or in the workshop – Festool mobile dust extractors are prepared for every challenge.

Page 186 — 187 — 188 — 189 — 190 — 190

CT 17

CTL SYS

CTL MINI

CTL MIDI

CTL 26/36

CTM 26/36



Applications

CLEANTEC mobile dust extractors, compact

CLEANTEC mobile dust extractors

Application area

Assembly (low quantities of coarse dust)

Workshop, industry

Building site, drywall construction (large quantities of fine dust)

Zone 22

Application

Extraction of dust from power tools

Dust extraction from air tools (LE variants)

Cleaning work

Continuous industrial use

Special features

Modular flexibility with 2 sockets/compressed air module

AUTOCLEAN fully automatic main filter cleaning system

Combination with ASA/EAA

Type of dust

Wood dust

Mineral, quartziferous dust

Aluminium, powder coating and polyurethane dust

Carcinogenic dust and asbestos

Technical data

	CT 17	CTL SYS	CTL MINI	CTL MIDI	CTL 26/36	CTM 26/36
Power consumption (W)	400 – 1.200	1.000	400 – 1.200	400 – 1.200	350 – 1.200	350 – 1.200
Max. flow rate (l/min)	3.700	3.000	3.700	3.700	3.900	3.900
Max. vacuum (Pa)	24.000	20.000	24.000	24.000	24.000	24.000
Max. container/filter bag capacity (l)	17/17	4,5/3,5	10/7,5	15/12,5	26/24 / 36/34	26/24 / 36/34
Dimensions (L x W x H) (mm)	445 x 380 x 485	396 x 296 x 270	430 x 330 x 422	430 x 330 x 470	630 x 365 x 540 630 x 365 x 596	630 x 365 x 540 630 x 365 x 596
Weight (kg)	9,4	6,9	8,8	9,1	13,9 / 14,4	13,9 / 14,4

Dust extraction

Overview of products and applications

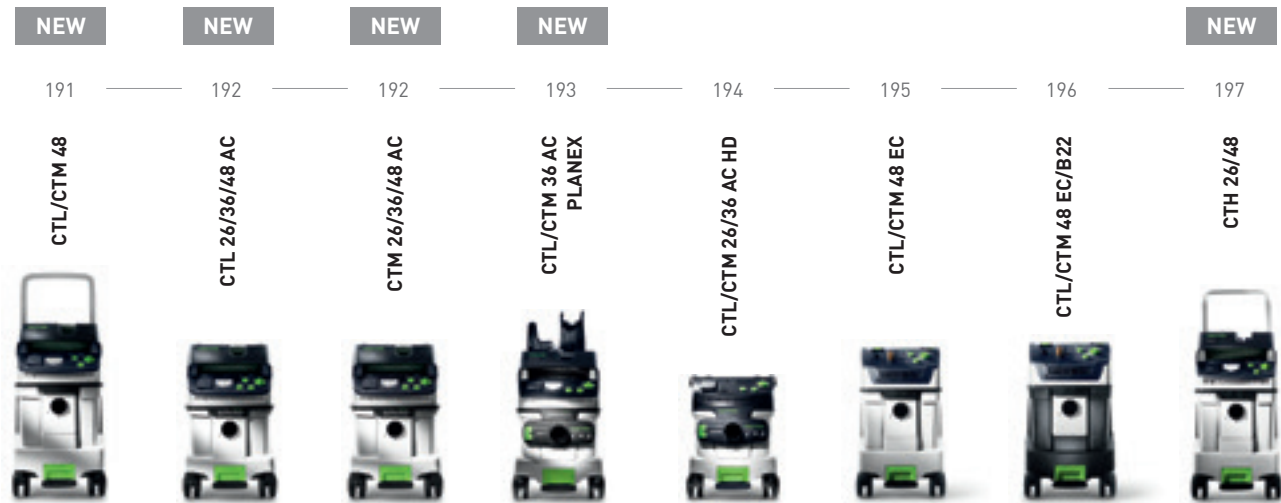

CLEANTEC mobile dust extractors

CLEANTEC AUTOCLEAN mobile dust extractors

CLEANTEC special extractors

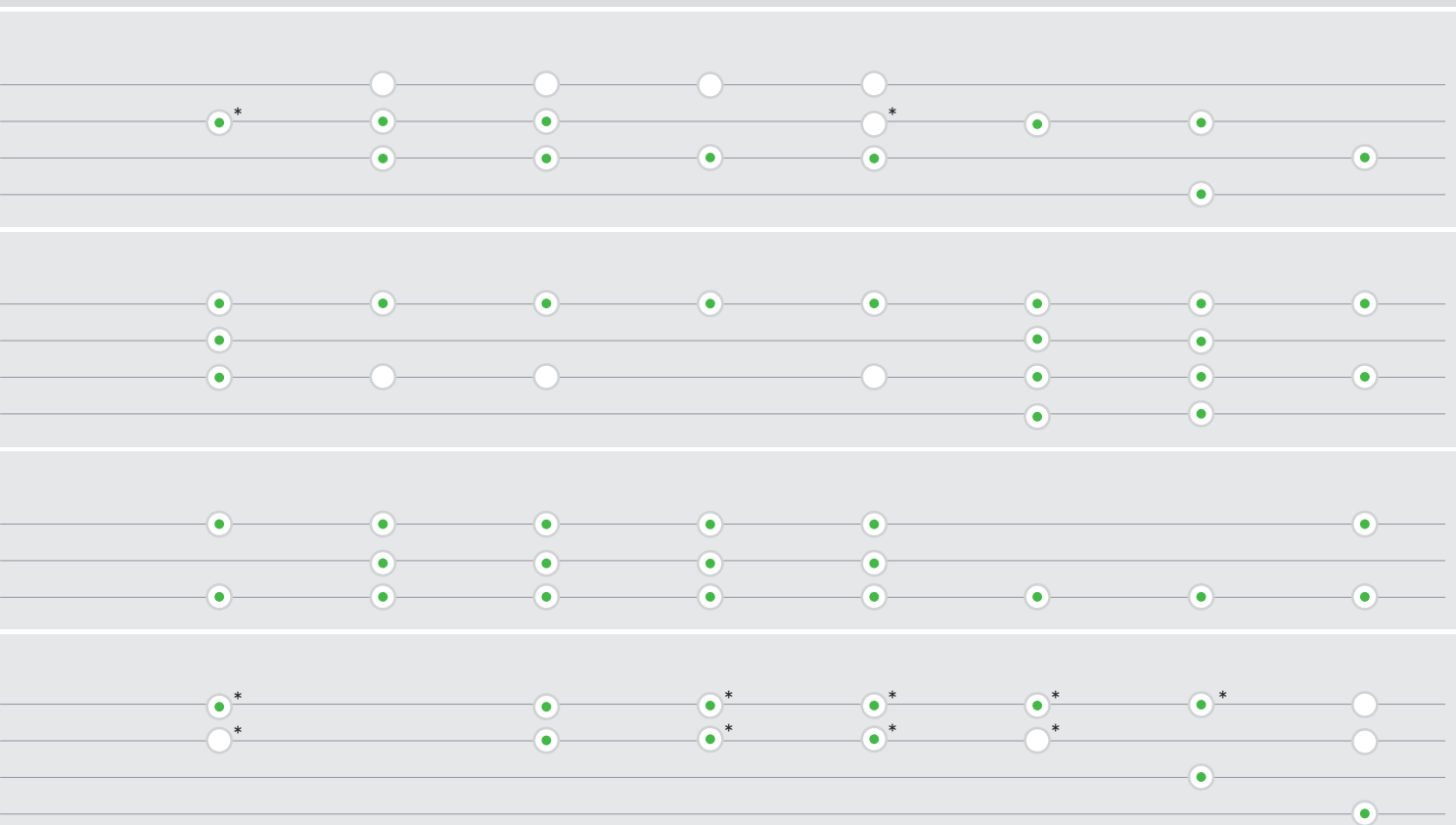

* CTM only ● Extremely appropriate ○ Appropriate

	350 – 1.200	350 – 1.200	350 – 1.200	350 – 1.200	350 – 1.200	150 – 1.100	150 – 1.100	350 – 1.000
	3.900	3.900	3.900	3.900	3.900	3.400	3.400	3.900
	24.000	24.000	24.000	24.000	24.000	23.000	23.000	24.000
	48/46	26/24 / 36/34 / 48/46	26/24 / 36/34 / 48/46	36/34	26/24 / 36/34	48/46	48/46	26/24 / 48/46
	740 x 406 x 1.005	630 x 365 x 540 630 x 365 x 596 740 x 406 x 1.005	630 x 365 x 540 630 x 365 x 596 740 x 406 x 1.005	630 x 365 x 596	673 x 365 x 455 673 x 365 x 522	630 x 406 x 640	630 x 406 x 640	630 x 365 x 540 740 x 406 x 1.005
	18,8	14,7 / 15,2 / 19,6	14,7 / 15,2 / 19,6	15,2	14,5 / 15,2	17,9	18,6	13,9 / 18,8

Dust extraction

We recommend using a dust extraction system.

We strongly recommend choosing the right extractor when selecting a dust extraction system.

When working in a dusty environment or handling materials that generate large quantities of dust, your main priority should be protecting your health. How harmful the dust is to your health depends on the size of the particles as well as the quantity and time that the materials remain inside your lungs.

The smaller the dust particles are, the deeper they can penetrate into the lung tissue and this is why finer particles are much more harmful to the airways, with many being categorised as extremely hazardous to health.

In the interests of your own health, it is imperative that you keep the air clean when handling mineral dust that invariably contains quartziferous substances and always work with a certified and approved dust extractor or safety extractor.

Your Industrial Employers' Liability Insurance Association will provide you with detailed information and specially prepared lists of substances that exceed specified OEL (occupational exposure limits).



CTL MINI/MIDI
CTL 26/36/48/
48 EC

Specialists for dust with
OEL > 1 mg/m³.



CTM 26/36/48/
48 EC

Specialists for dust with
OEL ≥ 0.1 mg/m³.
For quartziferous mineral
dust and wood dust.



CTH 26/48

Specialists for dust with
OEL > 0.1 mg/m³.
For carcinogenic and pathogenic
dust, e.g. asbestos and mould.



CTL 48 LE EC/B 22
CTM 48 LE EC/B 22

Specialised in the extraction of
flammable and explosive dust.

Dust categories in accordance with EN 60335-2-69, Appendix AA

	Appropriate	Max. permeability (test)	Disposal	Contamination risk
L (Low)	- dust with OEL > 1 mg/m ³	1% (filter material)		
M (Medium)	- dust with OEL ≥ 0.1 mg/m ³ - mineral dust - wood dust (also beech/oak)	0.1% (complete tool incl. upholstery nail test)	Dust-free	Cap for transportation
H (High)	- dust with OEL > 0.1 mg/m ³ - carcinogenic dust - dust containing pathogens	0.005% (complete tool incl. upholstery nail test)	Dust-free	Cap for transportation

Full utilisation of the container volume

The sophisticated container geometry, compatible SELFCLEAN filter bag and space-saving flat filter combine to produce a net volume that corresponds almost exactly to the gross volume of the container.



New and now even better: SYS DOCK

Simple transportation, better organisation and endless flexibility. The SYS-Dock with T-LOC for the safe connection of SYSTAINER, SORTAINER and SYS-ToolBox units.



Cable holder.

The cord can be wound up quickly and neatly thanks to the new cord holder. And – thanks to the sophisticated folding mechanism – can be easily removed from the holder without complex unwinding.



Hose garage

The integral hose holder eliminates the need for external hooks and protects the suction hose and mains cable from damage. The suction hose winds around the holder for clean, compact transportation.



Smooth suction hose with CLEANTEC sleeve

The new suction hose: Smooth and flexible – with a smooth exterior for perfect sliding over surfaces, a longer service life and greater suction power. The new CLEANTEC extraction sleeve ensures a secure fit on the tool.

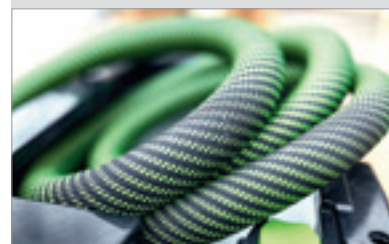

BLUETOOTH technology

CLEANTEC mobile dust extractors can be custom-retrofitted with the Bluetooth module. This means they can be operated via the remote control on the suction hose and start up automatically when Festool cordless tools with Bluetooth battery packs are switched on.



AUTOCLEAN automatic main filter cleaning system

Less cleaning work and constant suction power. The AUTOCLEAN automatic cleaning system eliminates the need to clean the main filter manually. Individual cleaning intervals can be defined to guarantee powerful, constant suction.



Dust-free work has never been so simple.

You can now save a trip to the extractor thanks to the Bluetooth module on the CLEANTEC mobile dust extractor. Combined with the remote control on the new smooth extractor hose, you can start dust extraction directly on the hose – ideal for small, occasional cleaning tasks.

The Bluetooth module communicates with the new Festool Bluetooth battery packs in addition to the remote control on the hose. Even a cordless tool starts your mobile dust extractor automatically when switched on. This now makes clean work in the Festool system simpler than ever before.



Simply practical.

You can use the remote control to start the mobile dust extractor directly at the suction hose. For simple switching to cleaning mode, even when the mobile dust extractor is in AUTO mode.

Simply smooth and even more effortless.

The new, more flexible extractor hose slides perfectly over every surface. And it has an extremely long service life thanks to its extremely robust, smooth exterior. All details can be found on page 201.



Simply communicative.

The new Bluetooth battery packs communicate with the Bluetooth module on the mobile dust extractor* – and ensure that the mobile dust extractor starts automatically when a cordless tool is switched on. This now enables you to benefit from Festool’s entire dust-free system when working with Festool cordless products too.



Simple to retrofit.

CLEANTEC mobile dust extractors can be retrofitted with the Bluetooth module in the free slot* – and the mobile dust extractor can be controlled remotely straight away via the remote control on the suction hose or the Bluetooth battery pack on a cordless tool.



Simply better.

The CLEANTEC mobile dust extractors provide clean air and a clear view of the workpiece. And they are now even more convenient thanks to the optimised SYS Dock. All details can be found on page 183.



* Bluetooth module available as an accessory. It should be installed by a skilled electrician.

Dust extraction

Mobile dust extractor CLEANTEC CT 17



CLEANTEC CT 17



Matter of cleanliness.

Ideal for cleaning offices, garages, vehicles and construction sites. Also suitable for extracting water.

Specialists for cleaning work.

- ▶ Maximum utilisation of filter bag capacity due to new, innovative design principle
- ▶ High suction performance and volume flow due to single-level powerful turbine
- ▶ Blow function with end cap on the rear of the housing
- ▶ Electronic level control for liquid suction

Technical data

Power consumption (W)	400 – 1.200
Max. volume flow (l/min)	3.700
Max. vacuum (Pa)	24.000
Filter surface area (cm ²)	4.600
Power cord (m)	5,5
Container/filter bag capacity (l)	17/17
Dimensions (L x W x H) (mm)	445 x 380 x 485
Max. appliance socket connected load (W)	2.400
Weight (kg)	9,4



■ = Electronic

Items included

CT 17 E GB 240V

double-wall filtering bag, suction hose Ø 27 mm x 3,5 with rotatable dust extraction coupling, in carton

Order no.

768472

System accessories from page 200





CTL SYS

04

The extractor in SYSTAINER format.

- ▶ Very small, lightweight and compact, in a SYSTAINER format for maximum mobility
- ▶ With a new suction hose: Smooth and flexible – with a smooth exterior which allows it to slide over surfaces perfectly
- ▶ The integrated hose, cable and nozzle store mean everything is always available
- ▶ Compatible with T-LOC in a SYSTAINER system for optimum workplace organisation

Technical data

Power consumption (W)	1.000
Max. volume flow (l/min)	3.000
Max. vacuum (Pa)	20.000
Filter surface area (cm ²)	5.357
Rubber-insulated mains cable (m)	5
Container/filter bag capacity (l)	4,5/3,5
Dimensions (L x W x H) (mm)	396 x 296 x 270
Max. appliance socket connected load (W)	1.200
Weight (kg)	6,9

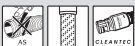

Items included

Order no.

CTL SYS GB 240V

575284

fitted filter bag, smooth suction hose dia. 27 x 3 m AS/CT with rotating angle adapter on the extractor side, hose holder, Sys-Dock with T-LOC function, upholstery nozzle D 36 PD, crevice nozzle D 36 FD-150, SYS-CT carrying belt, in carton



Spotless and space-saving.

The ideal extractor for fast and mobile use during relatively small fitting and servicing work: Very compact, lightweight, and quiet, and can be coupled with a SYSTAINER system. The SYSTAINER extractor is best suited to cleaning work with small volumes of dust and dirt. For class L dust.

**System accessories
 from page 200**



**SYSTAINER
 from page 422**

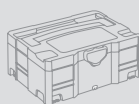

Dust extraction

Mobile dust extractor CLEANTEC CTL MINI



CLEANTEC CTL MINI



The small assembly extractor with 10 l container volume.

- ▶ Extremely compact and lightweight, for simple transport
- ▶ Better organisation thanks to hose depot for safe storage of hose and cable
- ▶ Strong suction power thanks to compact high-performance turbine and smooth, conical suction hose
- ▶ SYSTAINERS are secured to SYS-Dock in an instant

Technical data

Power consumption (W)	400 – 1.200
Max. volume flow (l/min)	3.700
Max. vacuum (Pa)	24.000
Filter surface area (cm ²)	5.000
Rubber-insulated mains cable (m)	7,5
Container/filter bag capacity (l)	10/7,5
Dimensions (L x W x H) (mm)	430 x 330 x 422
Max. appliance socket connected load (W)	2.400
Weight (kg)	8,8



■ = Electronic

Ideal for carrying en route.

With a low weight and compact dimensions, the CTL MINI is easy to transport and therefore the first choice for assembly tasks. The compact wet/dry extractor is ideal for extracting small to medium volumes of dust and dirt. For class L dust.

Items included

Order no.

fitted filter bag, smooth suction hose dia. 27/32 x 3.5 m AS/CT with rotating angle adapter on the extractor side, hose holder, Sys-Dock with T-LOC function, in carton

CTL MINI GB 240V

575258

CTL MINI GB 110V

575257

System accessories from page 200





CLEANTEC CTL MIDI

04

The compact assembly extractor with 15 l container volume.

- ▶ Extremely compact and lightweight, for simple transport
- ▶ Better organisation thanks to hose depot for safe storage of hose and cable
- ▶ Strong suction power thanks to compact high-performance turbine and smooth, conical suction hose
- ▶ SYSTEMERS are secured to SYS-Dock in an instant

Technical data

Power consumption (W)	400 – 1.200
Max. volume flow (l/min)	3.700
Max. vacuum (Pa)	24.000
Filter surface area (cm ²)	5.000
Rubber-insulated mains cable (m)	7,5
Container/filter bag capacity (l)	15/12,5
Dimensions (L x W x H) (mm)	430 x 330 x 470
Max. appliance socket connected load (W)	2.400
Weight (kg)	9,1



■ = Electronic

Items included	Order no.
fitted filter bag, smooth suction hose dia. 27/32 x 3.5 m AS/CT with rotating angle adapter on the extractor side, hose holder, Sys-Dock with T-LOC function, in carton	
CTL MIDI GB 240V	575265
CTL MIDI GB 110V	575264



Small on the outside, large on the inside.

The CTL MIDI is the ideal companion for assembly, installation and renovation work. The compact wet/dry extractor with 15 l container volume is perfect for extracting small to medium volumes of dust and dirt. For class L dust.

System accessories from page 200



Dust extraction

CLEANTEC CT 26 / CT 36 mobile dust extractors

NEW



product
design
award

2009

CLEANTEC CT 26 / CT 36



All-rounder in the perfect size.

Compact yet effective. Lightweight yet powerful. Whether on the construction site or in the bodyshop – the perfected container geometry of the CLEANTEC CT 26/36 offers a significantly larger capacity with minimal external dimensions.

The true size can be found inside.

- ▶ Maximum utilisation of the container volume – the gross volume is the same as the net volume
- ▶ Can be individually retrofitted with an additional socket, compressed air or Bluetooth module for remote control on the suction hose or automatic start via the Bluetooth battery pack
- ▶ Constantly high suction because of the compact high performance turbine
- ▶ Smooth suction hose and optimised SYS-Dock with cord holder and T-LOC function for conveniently connecting SYSTAINERS to the mobile dust extractor

Technical data	CT 26	CT 36
Power consumption (W)	350 – 1.200	350 – 1.200
Max. volume flow (l/min)	3.900	3.900
Max. vacuum (Pa)	24.000	24.000
Filter surface area (cm ²)	6.318	6.318
Rubber-insulated mains cable (m)	7,5	7,5
Container/filter bag capacity (l)	26/24	36/34
Dimensions (L x W x H) (mm)	630 x 365 x 540	630 x 365 x 596
Max. appliance socket connected load (W)	2.400	2.400
Weight (kg)	13,9	14,4



■ = Electronic

Items included	Order no.
SELF-CLEAN filter bag, smooth suction hose dia. 27/32 x 3.5 m AS/CT, hose holder, Sys-Dock with T-LOC function, cable holder, in carton	
CTL 26 E GB 240V	574951
CTL 26 E GB 110V	574950
CTL 36 E GB 240V	574968
CTM 26 E GB 240V end cap for intake adapter	575021

System accessories
from page 200



Workcenter WCR 1000
from page 405

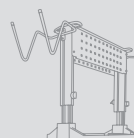

Dust extraction

Mobile dust extractor CLEANTEC CT 48

NEW



CLEANTEC CT 48

04

There's more to it than meets the eye.

- ▶ Large capacity for large volumes of dust and coarse chips
- ▶ Constantly high suction because of the compact high performance turbine
- ▶ Can be individually retrofitted with an additional socket, compressed air or Bluetooth module for remote control on the suction hose or automatic start via the Bluetooth battery pack
- ▶ Smooth suction hose and optimised SYS-Dock with cord holder and T-LOC function for conveniently connecting SYSTAINERS to the mobile dust extractor

Technical data

Power consumption (W)	350 - 1.200
Max. volume flow (l/min)	3.900
Max. vacuum (Pa)	24.000
Filter surface area (cm ²)	6.318
Rubber-insulated mains cable (m)	7,5
Container/filter bag capacity (l)	48/46
Dimensions (L x W x H) (mm)	740 x 406 x 1.005
Max. appliance socket connected load (W)	2.400
Weight (kg)	18,8



■ = Electronic

not available in Great Britain



For use in the workshop.

The CT 48 has a container volume of 48 litres, which is ideal for extracting large quantities of dust in the bodyshop. As CTL and CTM it is suitable for dust classes L and M.

System accessories
from page 200



Workcenter WCR 1000
from page 405

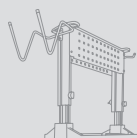

CT boom arm
on page 208



Dust extraction

Mobile dust extractors CLEANTEC CT 26 AC

NEW



product
design
award

2009

CLEANTEC CT 26 AC



No more clogged filters.

Prevent clogged filters with the CLEANTEC AC. An automated filter cleaning system keeps the filter clean and maintains a constant suction power. One-touch cleaning can be initiated at any time.

Fully automatic filter cleaning.

- ▶ AUTOCLEAN automatic main filter cleaning system with infinitely adjustable cleaning intervals for consistently high suction power
- ▶ Can be individually retrofitted with an additional socket, compressed air or Bluetooth module for remote control on the suction hose or automatic start via the Bluetooth battery pack
- ▶ Maximum utilisation of the container volume – the gross volume is the same as the net volume
- ▶ Smooth suction hose and optimised SYS-Dock with cord holder and T-LOC function for conveniently connecting SYSTAINERS to the mobile dust extractor

Technical data

Power consumption (W)	350 – 1.200
Max. volume flow (l/min)	3.900
Max. vacuum (Pa)	24.000
Filter surface area (cm ²)	6.318
Rubber-insulated mains cable (m)	7,5
Container/filter bag capacity (l)	26/24
Dimensions (L x W x H) (mm)	630 x 365 x 540
Max. appliance socket connected load (W)	2.400
Weight (kg)	14,7



= Electronic

Items included

High-performance main filter, SELFCLEAN filter bag, disposal bag, smooth suction hose dia. 27/32 x 3.5 m AS/CT, hose holder, Sys-Dock with T-LOC function, cable holder, in carton

Order no.	
574944	CTL 26 E AC GB 240V
574979	CTM 26 E AC GB 110V end cap for intake adapter
575020	CTM 26 E AC GB 240V end cap for intake adapter

System accessories from page 200



Workcenter WCR 1000 from page 405

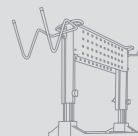

Dust extraction

Mobile dust extractor CLEANTEC CT 36 AC PLANEX

NEW



CLEANTEC CT 36 AC PLANEX

04

Ideal for drywall construction.

- ▶ The perfect mobile dust extractor for the PLANEX long-reach sander
- ▶ AUTOCLEAN automatic main filter cleaning system with infinitely adjustable cleaning intervals for consistently high suction power
- ▶ Constantly high suction because of the compact high performance turbine
- ▶ Antistatic function prevents static developing during work

Technical data

Power consumption (W)	350 – 1.200
Max. volume flow (l/min)	3.900
Max. vacuum (Pa)	24.000
Filter surface area (cm ²)	6.318
Rubber-insulated mains cable (m)	7,5
Container/filter bag capacity (l)	36/34
Dimensions (L x W x H) (mm)	630 x 365 x 596
Max. appliance socket connected load (W)	2.400
Weight (kg)	15,2



☐ = Electronic

Items included

CTM 36E AC-Planex GB 110V
in carton

Order no.

575430



Our contribution to a shorter work time.

The quicker a sander removes material, the more powerful the connected mobile dust extractor needs to be. The powerful CT 36 AC PLANEX was designed specifically for the extreme material removal rate of the PLANEX long-reach sander. Includes a tool holder, kink-proof hose and series standard ComfortClean closing slide for even more efficient filter cleaning. Perfect results every time at maximum speed.

System accessories
from page 200



PLANEX LHS 225
from page 116



Dust extraction

CLEANTEC CT 36 AC HD mobile dust extractor



CLEANTEC CT 36 AC HD



Heavy-duty tool.

The CT 26/36 AC HD is in its element when there is an abundance of dust, which occurs, for example, when working with masonry renovators and diamond grinders. The automatic main filter cleaning flushes the main filter regularly, thus ensuring a constantly high suction power.

The construction site extractor with automatic cleaning.

- ▶ AUTOCLEAN automatic main filter cleaning system for consistently high suction power
- ▶ Extremely robust design with large wheels and steel axis for use on the construction site
- ▶ Optimal for power tools with socket outlet and automatic switch-on with start-up and shut-down delay, as well as infinitely variable extraction power control
- ▶ Smooth suction hose and optimised SYS-Dock with cord holder and T-LOC function for conveniently connecting SYSTAINERS to the mobile dust extractor

Technical data

Power consumption (W)	350 - 1.200
Max. volume flow (l/min)	3.900
Max. vacuum (Pa)	24.000
Filter surface area (cm ²)	6.318
Rubber-insulated mains cable (m)	7,5
Container/filter bag capacity (l)	36/34
Dimensions (L x W x H) (mm)	673 x 365 x 522
Max. appliance socket connected load (W)	2.400
Weight (kg)	15,2



= Electronic

Items included

High-performance main filter, SELFCLEAN filter bag, disposal bag, smooth suction hose dia. 36/32 x 3.5 m AS with rotating connecting sleeves, Comfort clean closing slide, Accessory case, in carton

Order no.

CTM 36 E AC HD GB 240V

575290

System accessories from page 200



Renovation millers from page 367



Dust extraction

Mobile dust extractor CLEANTEC CT 48 EC



Brushless EC-TEC motor for a long service life and a high level of efficiency



CLEANTEC CT 48 EC

04

Designed for continuous industrial use.

- ▶ Constant power from the EC-TEC drive with a service life several times longer than a universal motor
- ▶ With a new suction hose: Smooth and flexible – with a smooth exterior which allows it to slide over surfaces perfectly
- ▶ Antistatic function prevents static developing during work
- ▶ With integrated connection for EAA and compressed air tools

Technical data

Power consumption (W)	150 – 1.100
Max. volume flow (l/min)	3.400
Max. vacuum (Pa)	23.000
Filter surface area (cm ²)	6.318
Rubber-insulated mains cable (m)	7,5
Container/filter bag capacity (l)	48/46
Dimensions (L x W x H) (mm)	630 x 406 x 640
Max. appliance socket connected load (W)	2.400
Weight (kg)	17,9



■ = Electronic

not available in Great Britain



Reliable. Durable. Powerful.

Tough continuous operation is its speciality and the EC-TEC drive concept guarantees greater reliability and a longer life. For relentless suction power when processing plastic, ceramic, wooden or painted surfaces.

System accessories
from page 200



Workcenter WCR 1000
from page 405

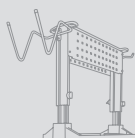

Energy box
from page 404

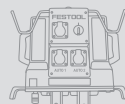

Dust extraction

Mobile dust extractor CLEANTEC CT 48 EC/B22



Brushless EC-TEC motor for a long service life and a high level of efficiency



CLEANTEC CT 48 EC/B22



For maximum safety.

- ▶ Conforms with ATEX Directive 94/9/EC for Zone 22 – dry and flammable dusts are reliably extracted
- ▶ Constant power from the EC-TEC drive with a service life several times longer than a universal motor
- ▶ With a new suction hose: Smooth and flexible – with a smooth exterior which allows it to slide over surfaces perfectly
- ▶ With integrated connection for EAA and compressed air tools

Technical data

Power consumption (W)	150 – 1.100
Max. volume flow (l/min)	3.400
Max. vacuum (Pa)	23.000
Filter surface area (cm ²)	6.318
Rubber-insulated mains cable (m)	7,5
Container/filter bag capacity (l)	48/46
Dimensions (L x W x H) (mm)	630 x 406 x 640
Max. appliance socket connected load (W)	2.400
Weight (kg)	18,6



■ = Electronic

not available in Great Britain

For dry and flammable dust.

The CT 48 EC/B22 special extractor with EC-TEC drive is designed for continuous use. The robust ABS plastic container is fitted with additional flame protection and is therefore suitable for the safe extraction of everything from aluminium, paper, soot and powder coating dust to glass-fibre and carbon-fibre reinforced plastics.

System accessories
from page 200



Workcenter WCR 1000
from page 405

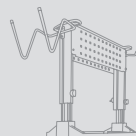

Energy box
from page 404

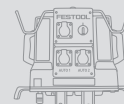

Dust extraction

Mobile dust extractor CLEANTEC CTH 26 / CTH 48

NEW



2019

CLEANTEC CTH 26 / CTH 48

04



No chance for hazardous dust.

- ▶ Approved for dust category H and asbestos dust
- ▶ Sealed tight – with dual-layer safety filter bag
- ▶ Convenient and with consistently high suction power thanks to the compact high-power turbine, infinitely variable suction power adjustment and antistatic function
- ▶ Smooth suction hose and optimised SYS-Dock with cord holder and T-LOC function for conveniently connecting SYSTAINERS to the mobile dust extractor

Technical data	CTH 26	CTH 48
Power consumption (W)	350 – 1.000	350 – 1.000
Max. volume flow (l/min)	3.900	3.900
Max. vacuum (Pa)	24.000	24.000
Filter surface area (cm ²)	6.318	6.318
Rubber-insulated mains cable (m)	7,5	7,5
Container/filter bag capacity (l)	26/24	48/46
Dimensions (L x W x H) (mm)	630 x 365 x 540	740 x 406 x 1.005
Max. appliance socket connected load (W)	2.400	2.400
Weight (kg)	13,9	18,8



■ = Electronic

not available in Great Britain

The specialist for the toughest demands.

Asbestos, mould, mineral fibre dust, lead, cadmium, nickel, zinc chromate. Many risks – one defence: the CTH special application extractor from Festool. Carcinogenic and pathogenic dust stand no chance. With a 99.995% degree of filtration even mould removal and asbestos abatement or wood-working with dangerous impregnating compounds pose no health problems.

System accessories
from page 200



The Festool system.

Because things work better when everything fits together: Which is why all Festool mobile dust extractors are equipped with an integrated hose garage and SYS-Dock for holding the SYSTAINER. Many models are also fitted with modular plug-in slots. A handle or removable tool holder can be added as an option. Furthermore, they are not only compatible with all Festool power and compressed air tools, but the various accessories are also interchangeable.



Dust extraction













Accessories and consumable materials

Cleaning sets	200
Suction hoses and hose sleeves	201
Tubes and nozzles	206
Modules and boom arms	208
Filters and filter bags	209
CT and compressed air accessories	214









Dust extraction

System accessories

CLEANTEC cleaning sets		Type	Order no.
	Cleaning set crevice nozzle D 36 FD-210, upholstery nozzle D 36 PD, suction brush D 36 SP, in self-service display pack	D 27 / D 36 D-RS	492392
	Standard cleaning set curved hand tube D 36 HR-K AS, extension pipes D 36 VR-K AS, 4-piece floor nozzle D 36 BD270, crevice nozzle D 36 FD-210, upholstery nozzle D 36 PD, in carton	D 27/D 36 S-RS	203428
	Professional cleaning set curved hand tube D 36 HR-K AS, extension tube, special steel 3-piece D 36 VR-M3x, carpet nozzle, D 36 TD, crevice nozzle D 36 FD-210, in carton	D 27/36 P-RS	203429
	Compact cleaning set curved hand tube D 36 HR-K AS, extension pipes D 36 VR-K AS, 4-piece floor nozzle D 36 BD270, crevice nozzle D 36 FD-210, upholstery nozzle D 36 PD, in SYSTAINER SYS 1 T-LOC	D 27/D 36 K-RS-Plus	203430
	Cleaning set for tradesmen smooth suction hose D 36, antistatic, curved hand tube D 36 HR-K AS, extension tube, special steel 3-piece D 36 VR-M3x, carpet nozzle, D 36 TD, crevice nozzle D 36 FD-210, upholstery nozzle D 36 PD, suction brush D 36 SP, in SYSTAINER SYS 5 T-LOC	D 36 HW-RS-Plus	203408
	Cleaning set for the workshop smooth suction hose D 36, antistatic, curved hand tube D 36 HR-K AS, extension tube, special steel 3-piece D 36 VR-M3x, floor nozzle, D 36 BD 370, in SYSTAINER SYS 5 T-LOC	D 36 WB-RS-Plus	203409
	Universal cleaning set Suction hose D 36, curved hand tube D 36 HR-K AS, extension pipes D 36 VR-K AS, floor nozzle, D 36 BD 300, crevice nozzle D 36 FD-210, suction brush D 36 SP, upholstery nozzle D 36 PD, in SYSTAINER SYS 5 T-LOC	D 36 UNI-RS-Plus	203435
	Cleaning set for industrial use suction hose Ø 50 x 2,5m, extension tubes D50VR-K, floor nozzle D 50 BD370, square nozzle D 50 QD, suction brush D 50 SP, crevice nozzle D 50 FD, in carton	D 50 GS-RS	454770
	Masonry renovation cleaning set curved hand tube D 36 HR-K AS, extension tube, special steel 3-piece D 36 VR-M3x, carpet nozzle, D 36 TD, crevice nozzle D 36 FD-210, upholstery nozzle D 36 PD, in SYSTAINER SYS 2 T-LOC	D 36 RS-M-Plus	203431
	Floor cleaning set curved hand tube D 36 HR-K AS, extension tube, special steel 3-piece D 36 VR-M3x, floor nozzle, D 36 BD 370, in SYSTAINER SYS 2 T-LOC	D 36 BD 370 RS-Plus	203432
	Construction cleaning set for all CT (except VCP 30 E) and VCP, construction set, suction hose D 36/32 x 3 m, curved hand tube D 36 HR-K AS, stainless steel extension tubes, 2-piece, 4-piece floor nozzle D 36 BD270, crevice nozzle D 36 FD-210, suction brush D 36 SP, in carton	D 36 BA-RS	203433
	Office cleaning set for all CT (except VCP 30 E) and VCP, office set, suction hose D 36/32 x 3 m, curved hand tube D 36 HR-K AS, stainless steel extension tubes, 2-piece, carpet nozzle, D 36 TD, upholstery nozzle D 36 PD, crevice nozzle D 36 FD-210, in carton	D 36 BU-RS	203434

Accessories for mobile dust extractors CT and dust extractors SR

CLEANTEC suction hose anti-static version





		Type	Order no.
	D 27 smooth antistatic suction hose for CTL SYS, temperature-resistant to +70°C, with rotating angle adapter at extractor side, bleeder resistor (DIN IEC 312) <1 mΩ/m, diameter 27 mm, length 3 m, in carton	D 27x3,0m-AS-90°/CT	201665
	D 27/32 smooth antistatic suction hose temperature-resistant to +70°C, bleeder resistor (DIN IEC 312) <1 mΩ/m, diameter 27 /32 mm, in carton		
	for CTL MINI/MIDI, with rotating angle adapter at extractor side, from YOM 09/2013, length 3,5 m	D 27/32x3,5m-AS-90°/CT	500680
	for CT 26/36/48, with rotating adapter and connector, length 3,5 m	D 27/32x3,5m-AS/CT	500677
	for CT 26/36/48, with rotating adapter and connector, length 5 m	D 27/32x5,0m-AS/CT	500678
	D 36 smooth antistatic suction hose for cleaning tasks with CT dust extractors, not suitable for dust extractors with Autoclean, temperature-resistant to +70°C, with rotating adapter and connector, bleeder resistor (DIN IEC 312) <1 mΩ/m, diameter 36 mm, in carton		
	length 3,5 m	D 36x3,5m-AS/CT	500681
	min. diameter 36 mm, length 5 m	D 36x5,0m-AS/CT	500684
	min. diameter 36 mm, length 7 m	D 36x7,0m-AS/CT	500685
	D 36/32 smooth antistatic suction hose suitable for dust extractors with Autoclean, temperature-resistant to +70°C, for masonry renovation and cleaning work, Conical, bleeder resistor (DIN IEC 312) <1 mΩ/m, diameter 36 /32 mm, length 3,5 m, in carton	D 36/32x3,5m-AS/CT	500682
	Suction hose D 36 antistatic for long-reach sander PLANEX, temperature-resistant to +70°C, extremely flexible, kink-resistant suction hose, diameter 36 mm, length 3,5 m, bleeder resistor (DIN IEC 312) <1 mΩ/m, in carton	D 36x3,5-AS/KS/LHS 225	496972
	ordered by metre (without rotating adapter or reducing sleeve), temperature-resistant to +70°C, bleeder resistor (DIN IEC 312) <1 mΩ/m, in carton		
	Suction hose D 27 antistatic diameter 27 mm	D 27 MW-AS	452384
	Suction hose D 36 antistatic diameter 36 mm	D 36 MW-AS	452385

Dust extraction









System accessories

Accessories for mobile dust extractors CT and dust extractors SR

CLEANTEC suction hose anti-static version

	Type	Order no.
 <p>Suction hose D 50 antistatic temperature-resistant to +70°C, bleeder resistor (DIN IEC 312) <1 mΩ/m, diameter 50 mm, in carton with 2x rotating adapter, length 2,5 m</p>	D 50x2,5m-AS	452888
<p>with 2x rotating adapter, length 4 m</p>	D 50x4m-AS	452890
 <p>ordered by metre (without rotating adapter or reducing sleeve)</p>	D 50 MW-AS	452386
 <p>Suction hose plug it D 27/22 antistatic smooth for all power tools with D27 and D36 flange (all Festool power tools) and cleaning accessories, suitable for sanding applications, with rotating adapter and reducing sleeve with bayonet fitting, temperature-resistant to +70°C, bleeder resistor (DIN IEC 312) <1 mΩ/m, diameter 27 /22 mm, in carton length 3,5 m</p>	D 27/22x3,5m-AS-GQ/CT	200041
<p>length 5 m</p>	D 27/22x5m-AS-GQ/CT	201758
 <p>Suction hose plug it D 32/22 antistatic smooth for all power tools with D27 and D36 flange (all Festool power tools) and cleaning accessories, suitable for sanding applications, with rotating adapter and reducing sleeve with bayonet fitting, temperature-resistant to +70°C, length 10 m, bleeder resistor (DIN IEC 312) <1 mΩ/m, diameter 32 /22 mm, in carton</p>	D 32/22x10m-AS-GQ/CT	200051

CLEANTEC suction hose

		Type	Order no.
	Suction hose D 21,5 for direct connection (without reducing ring) to hand sanding block with extraction, diameter 21,5 mm, length 5 m, in bag	D 21,5 x 5m HSK	495019
	Suction hose D 27 temperature-resistant to +70°C, diameter 27 mm, in carton with rotating adapter and connector, length 3,5 m	D 27x3,5m	452877
	with rotating adapter and connector, length 5 m	D 27x5m	452879
	ordered by metre (without rotating adapter or reducing sleeve)	D 27 MW	452383
	Suction hose D 36 temperature-resistant to +70°C, diameter 36 mm, in carton with rotating adapter and connector, length 3,5 m	D 36x3,5m	452881
	with rotating adapter and connector, length 5 m	D 36x5m	452883
	with rotating adapter and connector, length 7 m	D 36x7m	452885
	ordered by metre (without rotating adapter or reducing sleeve)	D 36 MW	454157
	Suction hose D 36/32 for all CT (except VCP 30 E) and VCP, temperature-resistant to +70°C, with rotatable dust extraction coupling, diameter 36/32 mm, length 3 m, in carton	D 36/32x3m	768114
	Suction hose D 50 ordered by metre (without rotating adapter or reducing sleeve), temperature-resistant to +70°C, diameter 50 mm, in carton	D 50 MW	454158
	Adapter hose for CS 50, CS 70, CMS, 0,5 m hose D36 with two rotating adapters and connection coupling, anti-static D50/D50 VM-AS, for Y-shaped connection in conjunction with CTL MINI/MIDI, diameter 36 mm, length 0,5 m, in carton	AD-D 36/CS50/CS70/CMS	499196







Dust extraction

System accessories

Accessories for mobile dust extractors CT and dust extractors SR

CLEANTEC hose sleeves

		Type	Order no.
     	Antistatic rotating adapter hose connector to fit inlet nozzle of dust extractor, external Ø 58 mm, in self-service display pack		
	for antistatic suction hose D 27	D 27 DAG-AS	452892
	for D 27/32 antistatic suction hose	D 32/27 DAG-AS/CT	500672
	for antistatic suction hose D 36	D 36 DAG-AS	202860
	for antistatic suction hose D 50	D 50 DAG-AS	452896
	for antistatic suction hose plug it D 27/22, smooth	D 36 DAG-AS-GQ/CT	202931
	for antistatic suction hose plug it D 32/22, smooth	D 50 DAG-AS-GQ/CT	203206
	Antistatic rotating angle adapter in self-service display pack		
	for D 22 and D 27 antistatic suction hoses on CTL MINI and CTL MIDI up to BJ 08/2013 and CTL SYS, hose connector for electric tool or suction nozzle, the bayonet fitting produces a secure connection between the mobile dust extractor and the power tool	D 27 DAG90-AS/CT	202505
	for antistatic suction hose D 32/27 on CTL MINI and CTL MIDI, from YOM 09/2013	D 32/27 DAG/90°-AS/CT	500673
   	Reducing sleeve, antistatic in self-service display pack		
	for suction hose D 27, for all power tools with D27 flange and cleaning accessories, hose connector for electric tool or suction nozzle, the bayonet fitting produces a secure connection between the mobile dust extractor and the power tool	D 27 DM-AS/CT	202346
	for all power tools with D27 and D36 flange (all Festool power tools) and cleaning accessories, only for the smooth suction hoses with integrated plug it cable, for connection to tools (power tools or suction nozzle), the secure connection between the mobile dust extractor and the power tool thanks to the bayonet fitting	D 27/22 DM-AS/CT	500668
	for suction hose D 36, for all power tools with D36 flange and cleaning accessories, hose connector for electric tool or suction nozzle, the bayonet fitting produces a secure connection between the mobile dust extractor and the power tool	D 36 DM-AS/CT	500670
	for D 36/32 suction hose, for all power tools with D36 flange and cleaning accessories, hose connector for electric tool or suction nozzle, the bayonet fitting produces a secure connection between the mobile dust extractor and the power tool	D 36/32 DM-AS/CT	500671

		Type	Order no.
	Reducing sleeve in self-service display pack		
	for suction hose D 36, for reducing to D 27 (machine)	RM D 36/27-AS	498528
			
	for all VCP/CT, dust extraction end, reduction of dia. 36 to 27 mm, diameter 36 mm	DC-D 36/27-AS	768135
	Reducing sleeve, antistatic for suction hose D 36, for long-reach sander PLANEX, hose connector for electric tool or suction nozzle, in self-service display pack	D 36 DM-AS-LHS 225	495013
	Extraction adapter for connecting a D 50 suction hose to D 36 accessory, in self-service display pack	D 50/D 36	452897
	Y-piece, antistatic for D 50/D 36/D 27, for connection of two dust extraction hoses, with blanking plug, for extractors that admit hazardous dust, simultaneous operation is not permitted, in self-service display pack	D 50 SV-AS/D 50 V	452898
	Blanking plug for closing the inlet nozzle, for retrofitting all CT/CTL mobile dust extractors, in self-service display pack	D 50/V	452899
	Antistatic connector sleeve to connect suction hoses D 50 / D 36 / D 27, the reducing sleeve on D 27/D 36 hoses must be replaced with a D 36/D 27 rotating adapter, in self-service display pack	D 50/D 50 VM-AS	493047

Dust extraction





System accessories

Accessories for mobile dust extractors CT and dust extractors SR



Tubes

		Type	Order no.
	Hand tube for D 27/D 36, antistatic, with sliding air regulator for suction power adjustment, curved, in self-service display pack	D 36 HR-K AS	203129
	Extension pipe for D 27/D 36, of stainless steel, 3-piece, length 950 mm, in self-service display pack	D 36 VR-M 3x	452902
	for D 27/D 36, antistatic, 3-piece, length 950 mm, in self-service display pack	D 36 VR-K AS 3x	203137
	for D 50, anodised aluminium, 1 piece, length 1.100 mm, in carton	D 50 VR-M	447599
	for D 50, plastic, 2 pieces, length 970 mm, in carton	D 50 VR-K 2x	440412

Floor nozzles





		Type	Order no.
	Floor nozzle for D 27/D 36, high-quality industrial design, aluminium, with 2 castors and 2 brush inserts, width 370 mm, in carton	D 36 BD 370	452908
	for D 50, high-quality industrial design, aluminium, with 2 castors and 2 brush inserts, width 450 mm, in carton	D 50 BD 450	452910
	for D 27/D 36, plastic, with 2 castors and 2 brush inserts, width 300 mm, in self-service display pack	D 36 BD 300	452907
	for D 27/D 36, 4 pieces, plastic, with 3 replaceable inserts (brushes, rubber lips, carpet), width 270 mm, in self-service display pack	D 36 BD 270	452906

Carpet and combination suction hose

		Type	Order no.
	Carpet nozzle for D 27/D 36, with sliding base, changeover from carpet to smooth floor, width 292 mm, in carton	D 36 TD	452911
	Turbo combination suction brush for D 27/D 36, for textile and linoleum floors, with 4 castors, brush rollers driven by intake air, width 270 mm, in carton	D 36 TKB	450644

Accessories for CT mobile dust extractors

Special nozzles/brushes



		Type	Order no.
	Crevice nozzle plastic, in self-service display pack for D 27/D 36, length 300 mm	D 36 FD-300	452904
	for D 27/D 36, length 210 mm	D 36 FD-210	492391
	for D 27/D 36, for CTL SYS, fits in the accessory storage of the CTL SYS, length 150 mm	D 36 FD-150	500593
	for D 50, length 200 mm	D 50 FD	452912
	Suction brush Plastic, in self-service display pack for D 27/D 36, diameter 70 mm	D 36 SP	440404
	for D 50, diameter 85 mm	D 50 SP	440419
	Upholstery nozzle for D 27/D 36, for CTL SYS, plastic, with brush insert, fits in the accessory storage of the CTL SYS, width 120 mm, in self-service display pack	D 36 PD	500592
	Universal brush nozzle for D 27/D 36, plastic, with brush rim and rotary hinge, in self-service display pack	D 36 UBD	498527
	Flat nozzle for D 27, special rubber, oil resistant, width 100 mm, in self-service display pack	D 27 FDG	440408

Dust extraction

System accessories



Accessories for CT mobile dust extractors

Modules for attachment system CTL/CTM 26/36/48



		Type	Order no.
	Energy box module for CT 26/36/48, for connecting a CT mobile dust extractor with an energy box or boom arm, not required in LE version, in carton	EAA CT 26/36/48	496143
	Electrical outlet module for CT 26/36/48, in carton		
	electrical outlet with continuous power	Modul-SD CT 26/36/48	496142
	electrical outlet with automatic On and Off switch	Modul-SD E/A CT 26/36/48	496405
	Compressed air module for CT 26/36/48, for upgrading E model mobile dust extractors, with additional compressed air automatic On and Off switching mechanism, in carton	DL CT 26/36/48	496141

Remote control

the remote control makes it possible to switch on the mobile dust extractor directly from the suction hose (simple changeover to cleaning mode, even when the mobile dust extractor is in AUTO model), range 10 m, technology Bluetooth, in carton







	Bluetooth remote control for CT 26, 36, 48, retrofit set for CT 26, 36, 48, module for installation in the free module slot (to be carried out by a qualified electrician), Remote operation via remote control (included in the set) or via cordless tool (in combination with Bluetooth battery pack), enables the mobile dust extractor to be started automatically when the cordless tool is switched on (compatible Bluetooth battery pack required), CT-F I extractor remote control, reception module (for CT 26, 36, 48)	CT-F I/M-Set	202097
	suitable for all dust extractors with Bluetooth (in combination with Bluetooth reception module), two fastening straps for D27 and D36 suction hoses	CT-F I	202098

CT boom arm

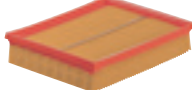
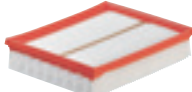
		Type	Order no.
	CT boom arm pipe set with connections, length 2.119 mm, width 1.136 mm, in carton		
	for CT 44, CT 48, without handle	CT-ASA	492452
	for CT22, CT 33, with handle SB-CT, handle	CT-ASA/SB	492767
	for CT 26/36, with the SB-CT 26/36 handle, boom arm for mounting to all CT 26/36 models (except CT 36 AC HD), handle	CT-ASA CT 26/36/SB	496372

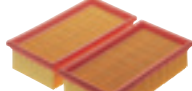
	Tool holder for CT-ASA, CT-ASA/SB, for safe, ergonomic storage of two electric power or pneumatic tools, in carton	WHR/CT-ASA	493558
---	--	------------	--------

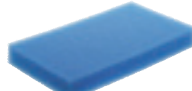
CLEANTEC filter









		Type	Order no.
	Filter element for CT 17 E, VCP 170 E, VCP 320 E, for dry extraction, in carton	HF-CT 17	769134
Main filter			
	for CTL MINI/MIDI, in self-service display pack	HF-CT-MINI/MIDI	456790
	For CT 26/36/48 and TURBO II, not suitable for mobile dust extractors with AUTOCLEAN function, in carton	HF-CT 26/36/48	496170
	for CT AC and VCP, for CT 26/36/48, main filter optimised for self-cleaning, in carton	High Performance HF CT 26/36/48	203759
	for CTH 26, CTH 48, special filter complies with the requirements of dust class H, in self-service display pack	HF CTH 26/48	498995
	for CT 11, 22, 33, 44, 55, qty. in pack 2 piece(s), in carton	HF-CT/2	452923
	for CTL SYS, in self-service display pack	HF-CT SYS	500558
	Long-life main filter for CT 11, 22, 33, 44, 55, used only for extraction of dust types which are not hazardous to health, qty. in pack 2 piece(s), in carton	Longlife-HF-CT/2	454869
Wet filter			
	for wet extraction		
	for CTL MINI/MIDI, in self-service display pack	NF-CT MINI/MIDI	456805
	for CT 26/36/48, in self-service display pack	NF-CT 26/36/48	496169
	for CT 11, 22, 33, 44, 55, qty. in pack 2 piece(s), in carton	NF-CT/2	452924
	for CT 17 E, VCP 170 E, VCP 320 E, VCP 171 E-L, VCP 321 E-L, in carton	NF-CT 17	769135

















Dust extraction

System accessories

Accessories for CT mobile dust extractors

CLEANTEC filter bags

		Type	Order no.
	Filter bag for CT 17 E, VCP 170 E, VCP 171 E-L, double wall, qty. in pack 5 piece(s), in carton	FIS-CT 17/5	769136
	SELFCLEAN filter bag qty. in pack 5 piece(s), in carton for CTL SYS, optimum usage of the filter bag volume, with highly tear resistant filter fleece, SELFCLEAN filter bag made of fleece material	SC FIS-CT SYS/5	500438
	for CTL MINI, optimum usage of filter bag volume and constantly high suction power thanks to SELFCLEAN filter bag	SC FIS-CT MINI/5	498410
	for CTL MIDI, optimum usage of filter bag volume and constantly high suction power thanks to SELFCLEAN filter bag	SC FIS-CT MIDI/5	498411
	for CT 26, optimum usage of filter bag volume and constantly high suction power thanks to SELFCLEAN filter bag	SC FIS-CT 26/5	496187
	for CT 36, optimum usage of filter bag volume and constantly high suction power thanks to SELFCLEAN filter bag	SC FIS-CT 36/5	496186
	for CT 48, optimum usage of filter bag volume and constantly high suction power thanks to SELFCLEAN filter bag	SC FIS-CT 48/5	497539
	Disposable bag not suitable for CT standard version (without AC), qty. in pack 5 piece(s), in carton		
	for CT 26 AC	ENS-CT 26 AC/5	496216
	for CT 36 AC/CTL 36 E AC HD	ENS-CT 36 AC/5	496215
	for CT/CTL/CTM 48 AC	ENS-CT 48 AC/5	497540
	Safety filter bag double-layered, qty. in pack 3 piece(s), in carton		
	for CTH 26	FIS-CTH 26/3	497541
	for CTH 48	FIS-CTH 48/3	497542



	Type	Order no.
Longlife filter bag		
used only for extraction of dust types which are not hazardous to health, from high strength, 3-layer polyester fleece with a long service life, Not recommended for fine dust		
	for CTL SYS, multiple filter bag for disposal of dust, in self-service display pack	Longlife-FIS-CT SYS 500642
	for CTL MINI, in carton	Longlife-FIS-CTL MINI 499703
	for CTL MIDI, in carton	Longlife-FIS-CTL MIDI 499704
	for CT 26, in carton	Longlife-FIS-CT 26 496120
	for CT 36, in carton	Longlife-FIS-CT 36 496121
	for CT 48, in carton	Longlife-FIS-CT 48 498506
	for CT 22, in carton	Longlife-FIS-CT 22 456737
	for CT 33, in carton	Longlife-FIS-CT 33 456738
Filter bag		
in carton		
	for CT 22, qty. in pack 5 piece(s)	FIS-CT 22/5 452970
	for CT 22, qty. in pack 20 piece(s)	FIS-CT 22/20 494631
	for CT 33, qty. in pack 5 piece(s)	FIS-CT 33/5 452971
	for CT 33, qty. in pack 20 piece(s)	FIS-CT 33/20 494632
	for CT 44, qty. in pack 5 piece(s)	FIS-CT 44/5 452972
	for CT 55, qty. in pack 5 piece(s)	FIS-CT 55/5 452973
	for CT 22, with spunbond outer layer, extremely tearproof, for extracting fine dust particles, qty. in pack 5 piece(s)	FIS-CT 22 SP VLIES/5 456870
	for CT 33, with spunbond outer layer, extremely tearproof, for extracting fine dust particles, qty. in pack 5 piece(s)	FIS-CT 33 SP VLIES/5 456871
	for CT 44, with spunbond outer layer, extremely tearproof, for extracting fine dust particles, qty. in pack 5 piece(s)	FIS-CT 44 SP VLIES/5 456874

Dust extraction

System accessories

Accessories for SR dust extractors

SR filter



		Type	Order no.
	Absolute filter in carton for SRM 45 LE-EC, SRM 70 LE-EC	AB-FI SRM 45/70	493826
	for SRH 45	AB-FI SRH 45	493825
	Main filter for SRM 45 E-PLANEX, VCP 450 E-L, VCP 450 E-M, Nano, in carton	NANO HF-SRM 45-LHS 225	496406

SR filter bags

		Type	Order no.
	Filter bag qty. in pack 5 piece(s), in carton for SRM 45 LE-EC	FIS-SRM 45 /5	493775
	for SRM 45 E-PLANEX, VCP 450 E-L, VCP 450 E-M	FIS-SRM 45-LHS 225 /5	495014
	for SRM 70 LE-EC	FIS-SRM 70 /5	493777
	for SRH 45 E	FIS-SRH 45 /5	493776

		Type	Order no.
	Disposable bag for SRM 45 E-PLANEX, VCP 450 E-L, VCP 450 E-M, qty. in pack 5 piece(s), in carton	ENS-SRM 45-LHS 225/5	495015

SR filters and filter bags for discontinued models













		Type	Order no.
	Absolute filter in carton		
	for SR 5, SR 200, SR 201	AB-FI/U	485808
	for SR151	AB-FI	488461
	for SR 6, SR 12, SR 14, SR 202, SR 203, SR 212, SR 301, SR 302, SR 303, application category C/M	AB-FI/C	486241
	Two-ply filter bag qty. in pack 5 piece(s), in carton		
	for SR 5, SR 6, double-layered	FIS-SR 5/6 /5	483143
	for SR 12, SR 14	FIS-SR 12/14 /5	483142
	for SR 151, SRM 152	FIS-SR 150 /5	488460
	for SR 200, SR 201, SR 203	FIS-SR 200 /5	487070
	for SR 301, SR 303, SRM 312	FIS-SR 300 /5	487790
	for SR15, SR12, SR14, for substances with dust emission limits and carcinogenic substances as defined by GefStoffV35, BIA-approved	FIS-SR 15 /5	483889
for SR 202, SR 212, SRH 204, SR 200, SR 201, SR 203	FIS-SR 202 /5	487482	

Dust extraction



System accessories

Accessories for mobile dust extractors CT and dust extractors SR

CT accessories

		Type	Order no.
	Hose holder for CT 11, 22, 33, 44, 55, for storing the suction hose and mains cable, suitable hose sizes: plug it hose D 22 x 3.5 m / D 27 x 3.5 m / D 27 x 5 m / D 36 x 3.5 m / D 50 x 2.5 m / IAS 2-3500 AS, dimensions (L x W x H) 530 x 360 x 110 mm, in carton	CT-SG	494388
	Tool holder in carton for CT 26/36, galvanised steel tool holder for sanders, for stable and ergonomic placement of an electrical or compressed air power tool	WHR-CT	496122
	for CT 36 PLANEX, with practical carrier handle, for storing PLANEX, not for PLANEX easy	WHR-CT 36-LHS 225	495964
	Handle for the convenient transportation of mobile dust extractors, in carton for CT 11, 22, 33, 44, 55	SB-CT	452921
	for CT 26/36, with nozzle holder	SB-CT 26/36	495802
	for CT 48, with nozzle holder	SB-CT 48	497295
	Sealing slide for CT AC / CT 36 AC PLANEX, ensures extreme vacuum in container, the filter undergoes thorough cleaning, in carton	VS-CT AC/SRM45 PLANEX	497926
	Adapter adapter for attaching the WCR and/or service unit VE CT 26/36/48 for CT 48 EC and CT 48 EC B22, in carton	AD-WCR	498805
	SYS adapter for CT 36 E HD-AC, CT 26 HD, VCP 260 E-L AC, VCP 260 E-M AC, VCP 260 E-H, from YOM 2011; VCP 480 E-L AC, VCP 480 E-M AC, for connecting Systainer to extractor, in self-service display pack	SYS-AP-CT 36 HD	768115
	Vacuum clamping nozzle for CT mobile dust extractors and D 27 suction hose, flexible aid for temporary clamping and fixing of workpieces at horizontal and vertical areas, max. clamping height 50 mm, max. load 3 kg, dimensions (L x W x H) 130 x 80 x 50 mm, weight 0,35 kg, in self-service display pack	CT-W	500312
	Shoulder strap for CT-SYS and all SYSTAINERs T-LOC, easy transport of the CTL SYS and the SYSTAINER T-LOC, max. load 20 kg, qty. in pack 1 piece(s), in self-service display pack	SYS-TG	500532
	Dirt trap to collect wet coarse dirt (e.g. cuttings + cooling lubricant), in carton for CT 22	SBH-CT 22	452925
	for CT 33	SBH-CT 33	452926

CT compressed air accessories

		Type	Order no.
	<p>Compressed air module to convert the CT mobile extractor, model E to LE design with additional automatic on/off switch for air tools, only suitable for CT 22/33/44, in carton</p>	DLM-CT	452829
	<p>Service unit for LE version of CT 26/36/48, pressure controller, condensate quick discharge, oiler and oil-free compressed air outlet with quick coupling, in carton</p>	VE-CT 26/36/48	495886
	<p>Assembly set for assembly of supply unit VE-CT 26/36 in conjunction with CT-ASA CT 26/36 SB, in carton</p>	MS DH VE-CT-ASA-CT26/36	496862



Drilling and Fastening

Overview of products and applications	218
Cordless drills CXS, TXS, C 18, T 18+3	220
Cordless hammer drill BHC 18	223
Cordless drills QUADRIVE DRC 18/4	224
Cordless impact drill QUADRIVE PDC 18/4	225
Drill QUADRILL DR 20	226
Cordless drywall screwdriver DURADRIVE DWC 18	227
Accessories and consumable materials	230
The Festool system	

Drilling and Fastening

Overview of products and applications

Power or precision, compact or durable, high torque or high speed: the task determines the requirements, Festool cordless drills provide the answers.

Page 220 ————— 220 ————— 221 ————— 222

CXS

TXS

C 18

T 18+3



Applications

Cordless drills

Screwdriving in wood, max. diameter

3x15	●	●	○	○
4x35	●	●	●	○
5x40	●	●	●	●
6x80	○	○	●	●

Screwdriving in wood, max. diameter

6x120	○	○	●	●
8x220	○	○	○	●
8x300	○	○	○	○
10x300	○	○	○	○
12x300	○	○	○	○

Drilling in wood, max. diameter

3	●	●	○	○
15	○	○	●	●
35	○	○	●	●
45	○	○	○	●
50	○	○	○	○
80	○	○	○	○

Drilling in stone (max. Ø drilling in stone)

Drilling in concrete (max. Ø drilling in concrete)

Drywall screwdriving – Wooden substructure (max. screw Ø 4.2 mm)

Drywall screwdriving – Sheet metal substructure (max. screw Ø 4.2 mm)

	○	○	○	○
--	---	---	---	---

Technical data

Battery voltage (V)	10,8	10,8	18	18
Battery capacity of standard/compact Li-ion battery pack (Ah)	2,6	2,6	5,2/3,1	5,2/3,1
Idling speed, 1st gear/2nd gear (rpm)	0 – 430/0 – 1.300	0 – 430/0 – 1.300	0 – 450/0 – 1.500	0 – 450/0 – 1.500
Idling speed, 3rd/4th gear (min. rpm)				
Max. torque, wood/steel (Nm)	10/16	10/16	27/45	35/50
Drilling diameter, wood/steel/stone (mm)	12/8/-	12/8/-	40/13/-	45/13/-
Chuck range (mm)	1 – 10	1 – 10	1,5 – 13	1,5 – 13
Tool holder	CENTROTEC	CENTROTEC	CENTROTEC	CENTROTEC
Weight with standard/compact battery pack (kg)	0,9	0,9	1,8/1,5	1,8/1,5

Drilling and Fastening

CXS, TXS cordless drills



CXS / TXS



When it comes to performance, size really isn't that important.

- ▶ Impressive ergonomics and low weight (0.9 kg) for convenient drilling and fastening
- ▶ The compact, handy shape makes work easier, even in cramped spaces
- ▶ FastFix interface and CENTROTEC quick tool-change system
- ▶ Practical – integrated LED light and battery charge indicator

Technical data	CXS	TXS
Battery voltage [V]	10,8	10,8
Gears	2	2
Idling speed, 1st gear/2nd gear [min ⁻¹]	0 – 430/0 – 1.300	0 – 430/0 – 1.300
Drilling diameter, wood/steel (mm)	12/8	12/8
Torque adjustment 1st/2nd gear (Nm)	0,3 – 3,4	0,3 – 3,4
Max. torque, wood/steel (Nm)	10/16	10/16
Chuck range (mm)	1 – 10	1 – 10
Li-ion battery capacity (Ah)	2,6	2,6
Li-ion charging time (min)	45	45
Weight with Li-ion (kg)	0,9	0,9



□ = Electronic

Items included	Order no.
2 x battery pack BP-XS, charger MXC, CENTROTEC tool chuck, CENTROTEC bit holder, FastFix keyless chuck 10 mm, XS elbow adapter, bit PZ 2, belt clip, in SYSTAINER SYS 1 T-LOC	
CXS Li 2,6-Set GB 240V	564533
TXS Li 2,6-Set GB 240V	564512

Genuine power pack.

The extra small 10.8 V cordless drills possess a remarkable torque, even in hard-to-reach places. Thanks to FastFix and the CENTROTEC rapid tool change system, they are convincingly flexible.

System accessories
from page 232



Bits and drills
from page 238



Drilling and Fastening

C 18 cordless drill



Brushless EC-TEC motor for a long service life and a high level of efficiency



product design award
2010

C 18



The perfect shape.

- ▶ Brushless EC-TEC motor with integrated motor management for long service life and the highest output
- ▶ Fully electronic torque setting and switch-off for precise screwdriving
- ▶ FastFix interface for all FastFix attachments and CENTROTEC rapid tool-change system
- ▶ Switchover from screwdriving to drilling without changing the set torque

Technical data	C 18 Plus/Set	C 18 Compact
Battery voltage (V)	18	18
Gears	2	2
Idling speed, 1st gear/2nd gear (min ⁻¹)	0 - 450/0 - 1.500	0 - 450/0 - 1.500
Drilling diameter, wood/steel (mm)	40/13	40/13
Torque adjustment 1st/2nd gear (Nm)	0,8 - 8/0,5 - 6	0,8 - 8/0,5 - 6
Max. torque, wood/steel (Nm)	27/45	27/45
Chuck range (mm)	1,5 - 13	1,5 - 13
Li-ion battery capacity (Ah)	5,2	3,1
Weight with Li-ion (kg)	1,8	1,5



■ = Electronic

Items included	Order no.
CENTROTEC tool chuck, CENTROTEC bit holder, FastFix keyless chuck 13 mm, bit PZ 2, belt clip, in SYSTAINER SYS 2 T-LOC	
C 18 Li-Basic without battery pack, without charger	574737
C 18 Li 3,1-Compact GB 2 x BP 18 Li 3.1 C battery pack, rapid charger TCL 6	574922
C 18 Li 5,2-Plus GB 2 x BP 18 Li 5.2 AS battery pack, rapid charger TCL 6	574740
C 18 Li 5,2-Set GB 2 x BP 18 Li 5.2 AS battery pack, SCA 8 rapid charger, FastFix angle attachment, FastFix eccentric attachment	574741

Distinctive stirrup shape.

The C 18 has won many awards for outstanding design with a proven brushless drive concept. The combination of lithium-ion battery packs and EC-TEC motor makes the C 18 even lighter and gives it even more power and battery life – making the C-series the most powerful ever.

System accessories from page 233

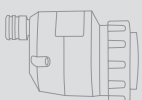

Bits and drills from page 238



Battery and charging technology from page 10 onwards

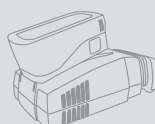

Drilling and Fastening

T18+3 cordless drills



product
design
award

2009

Brushless EC-TEC motor for a long service life and a high level of efficiency



T 18+3



Brains meet brawn.

The powerhouse of the T-series, featuring an 18-volt power supply and EC-TEC motor and a comfortable, lightweight design for excellent handling. The T 18+3 provides significantly better performance for the most challenging applications. With its brushless EC-TEC motor and Lithium-ion battery packs, this tool can drive over 1100 screws (5 x 40 mm in softwood) before needing to recharge (18 V – 5.2 Ah).

Brains meet brawn.

- ▶ FastFix interface for all FastFix attachments and CENTROTEC rapid tool-change system
- ▶ Impressive ergonomics: compact, lightweight and perfectly balanced
- ▶ Fully electronic torque setting and switch-off for precise screwdriving
- ▶ Switchover from screwdriving to drilling without changing the set torque

Technical data	T 18+3 Plus/Set	T 18+3 Compact
Battery voltage (V)	18	18
Gears	2	2
Idling speed, 1st gear/2nd gear (min ⁻¹)	0 – 450/0 – 1.500	0 – 450/0 – 1.500
Drilling diameter, wood/steel (mm)	45/13	45/13
Torque adjustment 1st/2nd gear (Nm)	0,8 – 8/0,5 – 6	0,8 – 8/0,5 – 6
Max. torque, wood/steel (Nm)	35/50	35/50
Chuck range (mm)	1,5 – 13	1,5 – 13
Li-ion battery capacity (Ah)	5,2	3,1
Weight with Li-ion (kg)	1,8	1,5



■ = Electronic

Items included	Order no.
CENTROTEC tool chuck, CENTROTEC bit holder, FastFix keyless chuck 13 mm, bit PZ 2, belt clip, in SYSTAINER SYS 2 T-LOC	
T 18+3 Li-Basic without battery pack, without charger	574763
T 18+3 Li 3,1-Compact GB 2 x BP 18 Li 3.1 C battery pack, rapid charger TCL 6	574909
T 18+3 Li 5,2-Plus GB 2 x BP 18 Li 5.2 AS battery pack, rapid charger TCL 6	574757
T 18+3 Li 5,2-Set GB 2 x BP 18 Li 5.2 AS battery pack, SCA 8 rapid charger, FastFix angle attachment, FastFix eccentric attachment	574759

System accessories from page 233

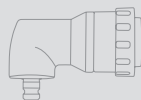

Bits and drills from page 238



Battery and charging technology from page 10 onwards

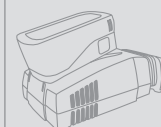

Drilling and Fastening

Cordless hammer drill BHC 18



Brushless EC-TEC motor for a long service life and a high level of efficiency



BHC 18

The most powerful compact hammer drill

- ▶ Unbeatable power to weight ratio thanks to the combination of EC-TEC motor and C shape model
- ▶ Vibration damping for effortless work; Maximum working comfort in all work situations
- ▶ Brushless EC-TEC motor with integrated motor management for long service life and the highest output
- ▶ High-quality lithium-ion battery technology for the longest sustained usage

Technical data	BHC 18 Plus	BHC 18 Compact
Battery voltage (V)	18	18
Gears	1	1
Idle engine speed (min ⁻¹)	0 – 1.100	0 – 1.100
Max. number of strokes (min ⁻¹)	4.895	4.895
Drilling dia. (concrete) (mm)	18	18
Max. crown borer hole diameter (mm)	68	68
Max. torque, wood/steel (Nm)	10/25	10/25
Tool holder	SDS-Plus	SDS-Plus
Single impact energy (J)	1,8	1,8
Li-ion battery capacity (Ah)	5,2	3,1
Weight with Li-ion (kg)	2,6	2,3



■ = Electronic

Items included	Order no.
additional side-mounted hand grip, depth stop, in SYSTAINER SYS 2 T-LOC	
BHC 18 Li-Basic without battery pack, without charger	574723
BHC 18 Li 3,1-Compact GB 2 x BP 18 Li 3.1 C battery pack, rapid charger TCL 6	574925
BHC 18 Li 5,2-Plus GB 2 x BP 18 Li 5.2 AS battery pack, rapid charger TCL 6	574721



Handy and compact – no compromises!

The BHC 18 slices through concrete with ease. It features an ergonomic design for maximum comfort while working, a pneumatic hammer mechanism to provide enormous impact energy and integrated vibration damping that absorbs the impact energy before it reaches your hands. The BHC 18 sets new standards thanks to its efficiency and ease of use and the best power-weight ratio in the 18 V class.

System accessories
from page 234



Battery and charging technology
from page 10 onwards

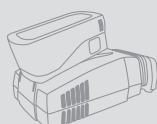

Drilling and Fastening

QUADRIVE DRC 18/4 cordless drill

Brushless EC-TEC motor for a long service life and a high level of efficiency



QUADRIVE DRC 18/4



The compact tool with impressive rotary power.

- ▶ Brushless EC-TEC motor for maximum service life and efficiency
- ▶ 4-speed gearbox capable of 3800 rpm for rapid, clean drilling results
- ▶ Universal solution for fastening operations that require high torque and for drilling large diameter holes
- ▶ Individually selectable LED lighting and battery status display

Technical data

Battery voltage (V)	18
Gears	4
Idling speed, 1st gear/2nd gear (min ⁻¹)	0 – 400/0 – 850
Idling speed, 3rd/4th gear (min ⁻¹)	0 – 1.850/0 – 3.800
Max. torque, wood/steel (Nm)	40/60
Drilling diameter (wood/steel) (mm)	50/13
Chuck range (mm)	1,5 – 13
Li-ion battery capacity (Ah)	5,2
Weight with Li-ion (kg)	1,9



□ = Electronic

Intelligent diversity.

60 Nm torque in first gear for powerful screwing, 3800 rpm in fourth gear for precise drilling. Untiring and enormously toughwhether on wood or metal – everyone who knows the QUADRIVE series is impressed by the combination of high power and absolute precision. The FastFix interface enables quick change to a CENTROTEC tool chuck, keyless chuck, crosshead or socket spanner adapter without the need for tools.

Items included

Order no.

CENTROTEC tool chuck, CENTROTEC bit holder, FastFix keyless chuck 13 mm, bit PZ 2, additional side-mounted hand grip, in SYSTAINER SYS 2 DF T-LOC

DRC 18/4 Li-Basic

without battery pack, without charger

574695

DRC 18/4 Li 5,2-Plus GB

2 x BP 18 Li 5.2 AS battery pack, rapid charger TCL 6

574698

DRC 18/4 Li 5,2-Plus-SCA GB

2 x BP 18 Li 5.2 AS battery pack, SCA 8 rapid charger

574917

DRC 18/4 Li 5,2-Set GB

2 x BP 18 Li 5.2 AS battery pack, SCA 8 rapid charger, angle chuck

574699

System accessories from page 235



Bits and drills from page 238



Battery and charging technology from page 10 onwards

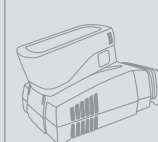

Drilling and Fastening

QUADRIVE PDC 18/4 cordless percussion drill



Brushless EC-TEC motor for a long service life and a high level of efficiency

QUADRIVE PDC 18/4



05

The multi-talented tool that makes a percussion.

- ▶ Brushless EC-TEC motor for maximum service life and efficiency
- ▶ EC-TEC motor combined with high-quality lithium-ion battery technology for up to 100% greater fastening capacity
- ▶ 4-speed gearbox capable of 3800 rpm for rapid, clean drilling results
- ▶ Individually selectable LED lighting and battery status display

Technical data

Battery voltage (V)	18
Gears	4
Idling speed, 1st gear/2nd gear (min ⁻¹)	0 – 400/0 – 850
Idling speed, 3rd/4th gear (min ⁻¹)	0 – 1.850/0 – 3.800
Max. number of strokes (min ⁻¹)	76.000
Max. torque, wood/steel (Nm)	40/60
Drilling diameter (wood/steel) (mm)	50/13
Drilling diameter in brickwork (mm)	10
Chuck range (mm)	1,5 – 13
Li-ion battery capacity (Ah)	5,2
Weight with Li-ion (kg)	2



■ = Electronic

Items included

Order no.

CENTROTEC chuck, CENTROTEC bit holder, FastFix keyless chuck 13 mm, bit PZ 2, additional side-mounted hand grip, in SYSTAINER SYS 2 DF T-LOC

PDC 18/4 Li-Basic 574701
without battery pack, without charger

PDC 18/4 Li 5,2-Plus GB 574705
2 x BP 18 Li 5.2 AS battery pack, rapid charger TCL 6

PDC 18/4 Li 5,2-Plus-SCA GB 574919
2 x BP 18 Li 5.2 AS battery pack, SCA 8 rapid charger

PDC 18/4 Li 5,2-Set GB 574706
2 x BP 18 Li 5.2 AS battery pack, SCA 8 rapid charger, angle chuck

System accessories from page 235



Bits and drills from page 238



Battery and charging technology from page 10 onwards

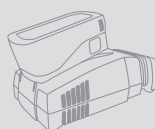

An argument with impact.

Much like the QUADRIVE DRC 18/4, the QUADRIVE PDC 18/4 offers a full range of features and sophisticated functionalities, and also provides an axial impact function that can be activated for drilling in masonry.

Drilling and Fastening

Drill QUADRILL DR 20



QUADRILL DR 20



The large QUADRILL with excellent speed.

The key feature of the QUADRILL DR 20 is the FastFix interface with which the machine can be set to different functions in an instant.

The high-torque drill.

- ▶ Multiple reduction gears that achieve a high torque
- ▶ Removable keyless chuck and bit holder in spindle, perfect for drilling and screwdriving
- ▶ Extremely robust and durable with large attachment collar, heavy-duty drive spindle and large spindle bearing
- ▶ Precision keyed chuck with FastFix and locking device

Technical data

Power consumption (W)	1.100
Gears	1
Idle engine speed (min ⁻¹)	0 – 650
Drilling diameter (steel/alu./wood) (mm)	20/28/65
Max. torque (Nm)	98
Chuck clamping range (mm)	3 – 16
Chuck interface	FastFix
Collar dia. (mm)	57
Weight (kg)	3,4
Weight (without chuck) (kg)	2,7



□ = Electronic

not available in Great Britain

System accessories
from page 236



Drilling and Fastening

Cordless drywall screwdriver DURADRIVE DWC 18



Brushless EC-TEC motor for a long service life and a high level of efficiency

DURADRIVE DWC 18

Power and durability for interior work.

- ▶ Precision, wear-free electronic switch-off function for accurate insertion depths and a long service life
- ▶ Energy-saving function for machine start/stop without actuating the main switch
- ▶ Robust, brushless EC motor for maximum efficiency and durability
- ▶ Rapid change to magazine attachment without using tools

Technical data	DW 18-2500 Plus	DW 18-2500 Compact	DW 18-4500 Plus	DW 18-4500 Compact
Battery voltage (V)	18	18	18	18
Gears	1	1	1	1
Idle engine speed (min ⁻¹)	0 – 2.500	0 – 2.500	0 – 4.500	0 – 4.500
Max. torque, wood/steel (Nm)	7/18	7/18	5/14	5/14
Max. machinable screw length (mm)	55	55	55	55
Tool holder	1/4"	1/4"	1/4"	1/4"
Li-ion battery capacity (Ah)	5,2	3,1	5,2	3,1
Weight with depth stop (kg)	1,9	1,6	1,9	1,6
Weight with magazine attachment (kg)	2,3	2	2,3	2



■ = Electronic

Items included	Order no.
magazine attachment, depth stop, scaffolding holder, magnetic bit holder, 2 x bit PH2, long, PH 2 bit, belt clip, in SYSTAINER SYS 2 T-LOC	
DWC 18-2500 Li-Basic without battery pack, without charger	574742
DWC 18-2500 Li 3,1-Compact GB 2 x BP 18 Li 3.1 C battery pack, rapid charger TCL 6	574912
DWC 18-2500 Li 5,2-Plus GB 2 x BP 18 Li 5.2 AS battery pack, rapid charger TCL 6	574744
DWC 18-4500 Li-Basic without battery pack, without charger	574747
DWC 18-4500 Li 3,1-Compact GB 2 x BP 18 Li 3.1 C battery pack, rapid charger TCL 6	574914
DWC 18-4500 Li 5,2-Plus GB 2 x BP 18 Li 5.2 AS battery pack, rapid charger TCL 6	574746



05

Raises the standard to a very high level.

Large-scale screwdriving applications in drywall construction can be completed conveniently, quickly and efficiently with the DURADRIVE DWC 18. It boasts high speed, low weight at 1.9 kg and a compact design. Its innovative stop-and-go function only activates the brushless EC-TEC motor when it is needed – enabling up to 40% increased screwdriving performance per battery charge. With the depth stop, the DWC can also be used for single screws.

System accessories from page 237



Drywall screws from page 243



Battery and charging technology from page 10 onwards

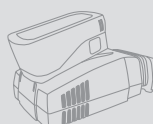

**Decidedly different:
Cordless drills by Festool.**



More time working, less time charging.

The EC-TEC drive concept stands for the extraordinary application of power with minimal power consumption across the entire speed range – from the insertion of large screws to drilling at speeds of up to 3800 rpm. The EC-TEC motor is wear-free, has no carbon brushes and is therefore maintenance-free and extremely robust.



Simply faster.

Drilling, countersinking and screwdriving: The CENTROTEC quick-change system is a drill chuck and bit holder in one, 50% smaller and 80% lighter than a standard drill chuck. The direct and reliable power transmission by the rotary holder directly and centrally in the machine shaft prevents the drill bit from penetrating through, even in hard materials.



A tool that works without needing tools.

Mounted and quickly replaced without the need for tools: The cordless drills or the powerful QUADRILL mains-operated drill can be retrofitted in an instant to a maximum of five tools: Drill, screwdriver, elbow drill, elbow screwdriver or drywall screwdriver, using the FastFix attachments.



Our recommendation – Request repairs online!

You need **5 minutes.** We need no more than **48 hours.**

Save yourself the journey to the dealer. Save yourself the effort of packing your tools. Save yourself the long explanations. And, above all, save yourself the annoying wait before you get your repaired tool back. Because this is our promise to you: We repair all tools within 48 hours after they arrive at our workshop, and then we send them directly back to their owners.

How does it work? Simple!

With the online repair request service. Log in, fill in a short request and you're done.

- ▶ Free collection directly from you.
- ▶ Current status information on the repair by text message or e-mail.
- ▶ First-class repair quality.
- ▶ Original spare parts and electrical safety test with certificate.
- ▶ Fast and free return.

The Festool online repair request service. Repairs have never been quicker.

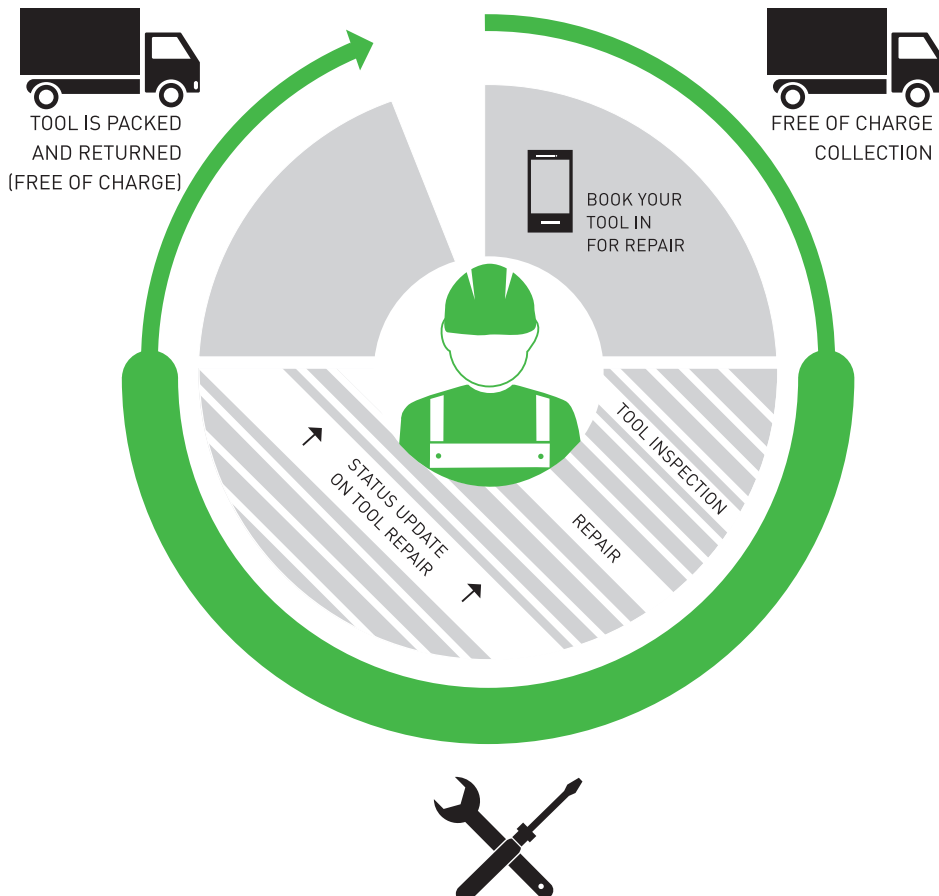

The Festool system.

Because things work better when everything fits together: System accessories, matching quick-change attachments, a diverse range of screwdriver and drill bits with the CENTROTEC tool system as well as ingenious battery packs with a charge indicator have made Festool cordless drill and rotary impact driver series even better, more flexible and reliable.



Drilling and Fastening

Accessories and consumable materials

System accessories	232
CENTROTEC tool range	238
Drilling guide systems	243



Drilling and Fastening

System accessories



CXS



TXS

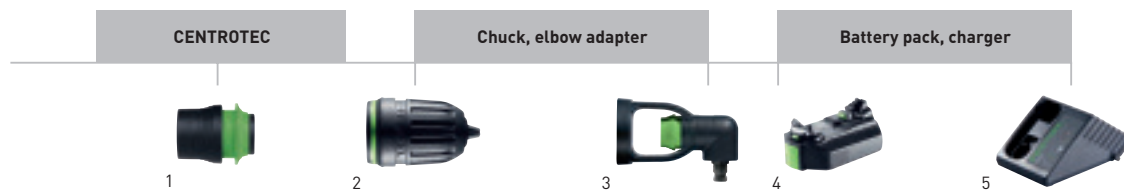

Accessories for CXS and TXS cordless drills

Denomination	Explanation	Order no.
1 Tool chuck WH-CE CENTROTEC	for all Festool cordless and mains-operated drills (except DR 20/DRP 20) with CENTROTEC interface, in self-service display pack	492135
2 Keyless chuck BF-FX 10	for Festool cordless drills CXS and TXS, clamping range 1 – 10 mm, in self-service display pack	499949
3 Angle attachment XS-AS	for CXS and TXS cordless drills, for working in tight spaces, in self-service display pack	497951
4 Battery pack BP-XS 2.6 Ah Li-Ion	lithium-ion spare battery for cordless drills CXS and TXS, tensioner 10,8 V, capacity 2,6 Ah, weight 0,2 kg, in self-service display pack	500184
5 Charger MXC GB	for BP-XS battery packs, for CXS and TXS cordless drills, charging current 2,8 A, input voltage 220 – 240 V, in carton	497496

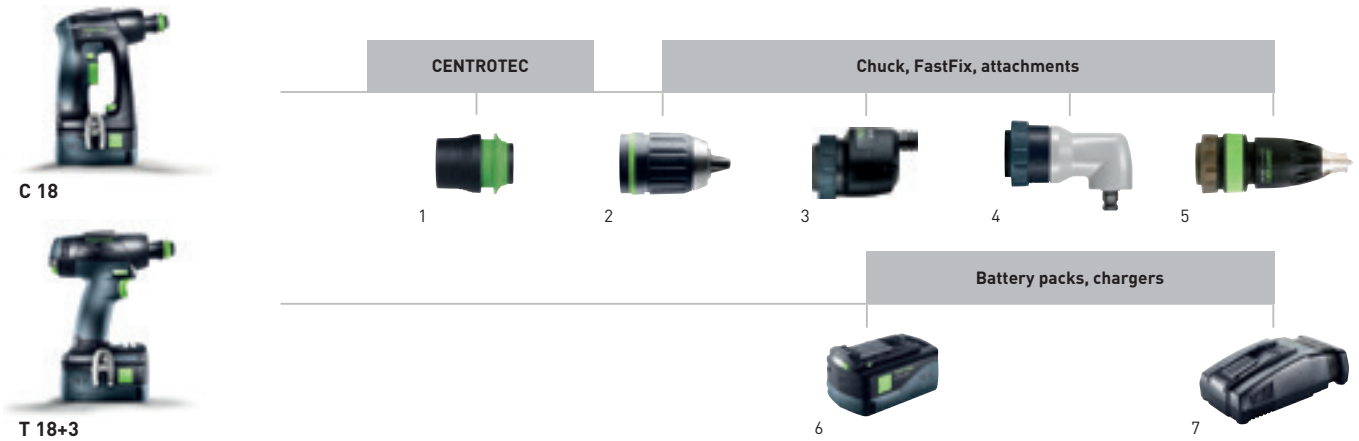

Accessories for C 18, T 18+3 cordless drills

Denomination	Explanation	Order no.
1 Tool chuck WH-CE CENTROTEC	for all Festool cordless and mains-operated drills (except DR 20/DRP 20) with CENTROTEC interface, in self-service display pack	492135
2 Keyless chuck KC 13-1/2-K-FFP	for all Festool cordless drills, cordless impact drills, drills (except DR 20/DRP 20) and impact drills with CENTROTEC interface, impact resistant, plastic ring, with locking device, holder FastFix, clamping range 1,5 – 13 mm, in self-service display pack	769067
3 FastFix eccentric attachment DD-ES	for all Festool C and T cordless drills with FastFix interface (except CXS/TXS), in self-service display pack	490294
4 FastFix angle attachment DD-AS	for all Festool C and T cordless drills with FastFix interface (except CXS/TXS), in self-service display pack	490293
5 Depth stop FastFix DD-DC	for all Festool C and T cordless drills with FastFix interface (except CXS/TXS), in self-service display pack	493539
6 Battery pack BP 18 Li 5,2 AS	with AIRSTREAM function, lithium-ion (Li-ion) replacement battery pack for all Festool 18 V cordless tools (except CXS/TXS, RTSC, DTSC, ETSC), tensioner 18 V, capacity 5,2 Ah, weight 0,7 kg, in self-service display pack	200181
Battery pack BP 18 Li 5,2 AS-ASI	Bluetooth lithium-ion (Li-ion) battery pack with AIRSTREAM function for all Festool 18 V cordless tools (except CXS/TXS, RTSC, DTSC, ETSC), Bluetooth enables the CLEANTEC mobile dust extractor to be started automatically when the cordless tool is switched on (use of the Bluetooth module at the free slot on the CLEANTEC mobile dust extractor is required), tensioner 18 V, capacity 5,2 Ah, weight 0,7 kg, in carton	202479
Battery pack BP 18 Li 6,2 AS-ASI	Bluetooth lithium-ion (Li-ion) battery pack with AIRSTREAM function for all Festool 18 V cordless tools (except CXS/TXS, RTSC, DTSC, ETSC), Bluetooth enables the CLEANTEC mobile dust extractor to be started automatically when the cordless tool is switched on (use of the Bluetooth module at the free slot on the CLEANTEC mobile dust extractor is required), tensioner 18 V, capacity 6,2 Ah, weight 0,7 kg, in carton	201797
Battery pack BP 18 Li 3,1 C	compact, lightweight design, lithium-ion (Li-ion) replacement battery pack for all Festool 18 V cordless tools (except TSC 55, CXS/TXS, RTSC, DTSC, ETSC), tensioner 18 V, capacity 3,1 Ah, weight 0,4 kg, in self-service display pack	201789
7 Rapid charger TCL 6 GB 240V	for all Li-ion battery packs (except for CXS/TXS), Lithium-ion (Li-ion) replacement charger for all 10.8 – 18 V battery packs, charging current 6 A, input voltage 220 – 240 V, weight 0,8 kg, in self-service display pack	201136
Rapid charger SCA 8 GB 240V	for all Li-ion battery packs (except for CXS/TXS), with AIRSTREAM function, Lithium-ion (Li-ion) replacement charger for all 10.8 – 18 V battery packs, charging current 8 A, input voltage 220 – 240 V, weight 1,1 kg, in self-service display pack	200311
Battery and charging technology	from page 10	

Drilling and Fastening

System accessories



Accessories for cordless hammer drill BHC 18

Denomination	Explanation	Order no.
1 Hammer drill SDS+Set	for cordless hammer drills BHC 18 and all other hammer drills with SDS-Plus tool reception, 1 x D 5x50, 2 x D 6x50, 1 x D 6x100, 1 x D 8x100, 1 x D 10x100, 1 x D 12x100, qty. in pack 7 piece(s), in self-service display pack	499924
2 Adapter AD SDS-plus/FastFix	for BHC 18, RHP 18, CHP 26, for holding a CENTROTEC tool chuck, in self-service display pack	769068
3 Tool chuck WH-CE CENTROTEC	for all Festool cordless and mains-operated drills (except DR 20/DRP 20) with CENTROTEC interface, in self-service display pack	492135
4 Auxiliary handle AH-43/185	for all QUADRIVE DRC 18/4, PDC 18/4 and BHC 18, for absorbing higher torques, length 185 mm, holder dia. 43 mm, in self-service display pack	768615
5 Drilling dust nozzle D 27-BSD	for BHC 18, PDC 18, PD 20 and mobile dust extractors CT/CTL/CTM, adapter with flexible insert, drill sleeve made from nickel-plated steel, compatible with all standard industrial and domestic vacuum cleaners, exception: must be deactivated on extractors with automatic filter cleaning system, connection dia. 27-32 mm, drill bit dia. 0 - 12 mm, in self-service display pack	500483
6 Battery pack BP 18 Li 5,2 AS	with AIRSTREAM function, lithium-ion (Li-ion) replacement battery pack for all Festool 18 V cordless tools (except CXS/TXS, RTSC, DTSC, ETSC), tensioner 18 V, capacity 5,2 Ah, weight 0,7 kg, in self-service display pack	200181
Battery pack BP 18 Li 5,2 AS-ASI	Bluetooth lithium-ion (Li-ion) battery pack with AIRSTREAM function for all Festool 18 V cordless tools (except CXS/TXS, RTSC, DTSC, ETSC), Bluetooth enables the CLEANTEC mobile dust extractor to be started automatically when the cordless tool is switched on (use of the Bluetooth module at the free slot on the CLEANTEC mobile dust extractor is required), tensioner 18 V, capacity 5,2 Ah, weight 0,7 kg, in carton	202479
Battery pack BP 18 Li 6,2 AS-ASI	Bluetooth lithium-ion (Li-ion) battery pack with AIRSTREAM function for all Festool 18 V cordless tools (except CXS/TXS, RTSC, DTSC, ETSC), Bluetooth enables the CLEANTEC mobile dust extractor to be started automatically when the cordless tool is switched on (use of the Bluetooth module at the free slot on the CLEANTEC mobile dust extractor is required), tensioner 18 V, capacity 6,2 Ah, weight 0,7 kg, in carton	201797
Battery pack BP 18 Li 3,1 C	compact, lightweight design, lithium-ion (Li-ion) replacement battery pack for all Festool 18 V cordless tools (except TSC 55, CXS/TXS, RTSC, DTSC, ETSC), tensioner 18 V, capacity 3,1 Ah, weight 0,4 kg, in self-service display pack	201789
7 Rapid charger TCL 6 GB 240V	for all Li-ion battery packs (except for CXS/TXS), Lithium-ion (Li-ion) replacement charger for all 10.8 - 18 V battery packs, charging current 6 A, input voltage 220 - 240 V, weight 0,8 kg, in self-service display pack	201136
Rapid charger SCA 8 GB 240V	for all Li-ion battery packs (except for CXS/TXS), with AIRSTREAM function, Lithium-ion (Li-ion) replacement charger for all 10.8 - 18 V battery packs, charging current 8 A, input voltage 220 - 240 V, weight 1,1 kg, in self-service display pack	200311
Battery and charging technology	from page 10	

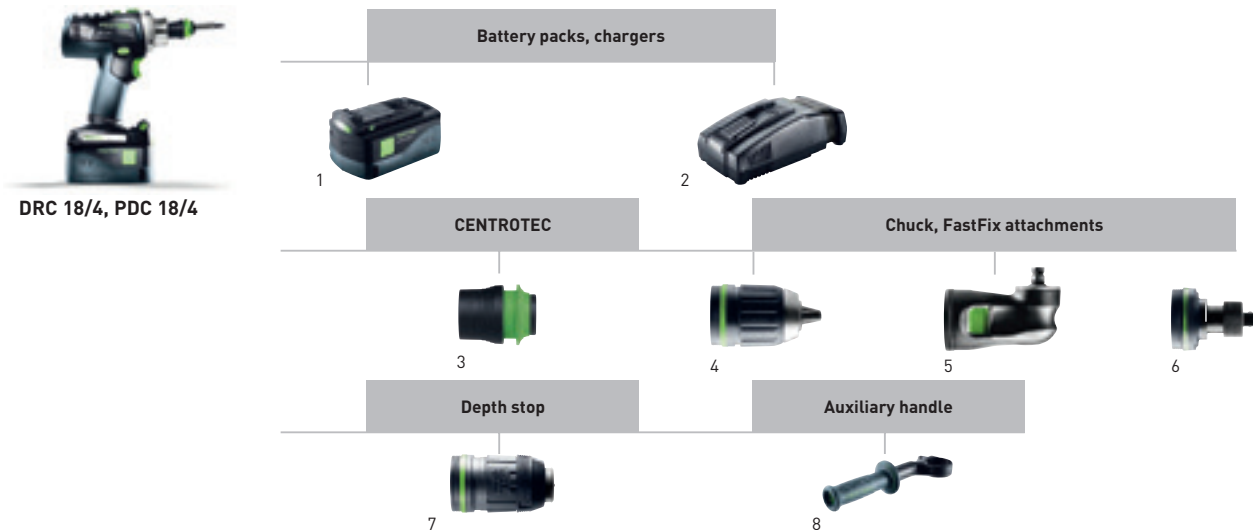

Accessories for QUADRIVE DRC 18/4 cordless drills, QUADRIVE PDC 18/4 cordless impact drills

Denomination	Explanation	Order no.
1 Battery pack BP 18 Li 5,2 AS	with AIRSTREAM function, lithium-ion (Li-ion) replacement battery pack for all Festool 18 V cordless tools (except CXS/TXS, RTSC, DTSC, ETSC), tensioner 18 V, capacity 5,2 Ah, weight 0,7 kg, in self-service display pack	200181
Battery pack BP 18 Li 5,2 AS-ASI	Bluetooth lithium-ion (Li-ion) battery pack with AIRSTREAM function for all Festool 18 V cordless tools (except CXS/TXS, RTSC, DTSC, ETSC), Bluetooth enables the CLEANTEC mobile dust extractor to be started automatically when the cordless tool is switched on (use of the Bluetooth module at the free slot on the CLEANTEC mobile dust extractor is required), tensioner 18 V, capacity 5,2 Ah, weight 0,7 kg, in carton	202479
Battery pack BP 18 Li 6,2 AS-ASI	Bluetooth lithium-ion (Li-ion) battery pack with AIRSTREAM function for all Festool 18 V cordless tools (except CXS/TXS, RTSC, DTSC, ETSC), Bluetooth enables the CLEANTEC mobile dust extractor to be started automatically when the cordless tool is switched on (use of the Bluetooth module at the free slot on the CLEANTEC mobile dust extractor is required), tensioner 18 V, capacity 6,2 Ah, weight 0,7 kg, in carton	201797
Battery pack BP 18 Li 3,1 C	compact, lightweight design, lithium-ion (Li-ion) replacement battery pack for all Festool 18 V cordless tools (except TSC 55, CXS/TXS, RTSC, DTSC, ETSC), tensioner 18 V, capacity 3,1 Ah, weight 0,4 kg, in self-service display pack	201789
2 Rapid charger TCL 6 GB 240V	for all Li-ion battery packs (except for CXS/TXS), Lithium-ion (Li-ion) replacement charger for all 10.8 – 18 V battery packs, charging current 6 A, input voltage 220 – 240 V, weight 0,8 kg, in self-service display pack	201136
Rapid charger SCA 8 GB 240V	for all Li-ion battery packs (except for CXS/TXS), with AIRSTREAM function, Lithium-ion (Li-ion) replacement charger for all 10.8 – 18 V battery packs, charging current 8 A, input voltage 220 – 240 V, weight 1,1 kg, in self-service display pack	200311
Battery and charging technology	from page 10	
3 Tool chuck WH-CE CENTROTEC	for all Festool cordless and mains-operated drills (except DR 20/DRP 20) with CENTROTEC interface, in self-service display pack	492135
4 Keyless chuck KC 13-1/2-K-FFP	for all Festool cordless drills, cordless impact drills, drills (except DR 20/DRP 20) and impact drills with CENTROTEC interface, impact resistant, plastic ring, with locking device, holder FastFix, clamping range 1,5 – 13 mm, in self-service display pack	769067
Keyless chuck KC 13-1/2-MMFP	for all Festool cordless drills, cordless impact drills, drills (except DR 20/DRP 20) and impact drills with CENTROTEC interface, impact-resistant, metal ring, with locking device., holder FastFix, clamping range 1,5 – 13 mm, in self-service display pack	769065
5 Angle attachment AU-43 FFP	for DRC 18/4, PDC 18/4, DR 18/4 E, PD 20/4 E, DRP 16 ET, DRP 18-4 DEC, PDP 20-4 DEC, holder FastFix, collar dia. 43 mm, in self-service display pack	769097
6 Adapter AD-3/8" FF	for DRC 18/4, PDC 18/4, DR 18/4 E, PD 20/4 E, DRP 16 ET, DRP 18-4 DEC, PDP 20-4 DEC and all C+T drivers, for holding socket wrenches with 3/8" square i.a.w. DIN 3121 (machine-operated assembly tools), holder FastFix, in self-service display pack	769064
7 Depth stop DC UNI FF	for DRC 18/4, PDC 18/4, DR 18/4 E, PD 20/4 E, DRP 16 ET, DRP 18-4 DEC, PDP 20-4 DEC and all C+T drivers, stop sleeves Ø 17 mm + 23 mm, PH 2 bit, socket wrench, size 8, holder FastFix, in self-service display pack	769126
Guard ring PR D17-DC UNI FF 5x	for DC UNI FF, 5 protective rings for stop sleeves Ø 17 mm, D 17 mm, in self-service display pack	768125
Guard ring PR D23-DC UNI FF 5x	for DC UNI FF, 5 protective rings for stop sleeve Ø 23 mm, D 23 mm, in self-service display pack	768127
Socket spanner S W 3/8"-DC UNI FF 2x	for depth stop DC UNI FF, 2 socket wrenches SW 8 with ball clamping effect, holder 3/8", in self-service display pack	768165
Socket spanner SW 8-DC UNI FF 2x	for depth stop DC UNI FF, 2 socket wrenches SW 8 with ball clamping effect, holder 1/4", in self-service display pack	768113
8 Auxiliary handle AH-43/230	for all QuaDrill DR 18/4 and PD 20/4, for absorbing higher torques, holder dia. 43 mm, length 230 mm, in self-service display pack	768613

Drilling and Fastening

System accessories

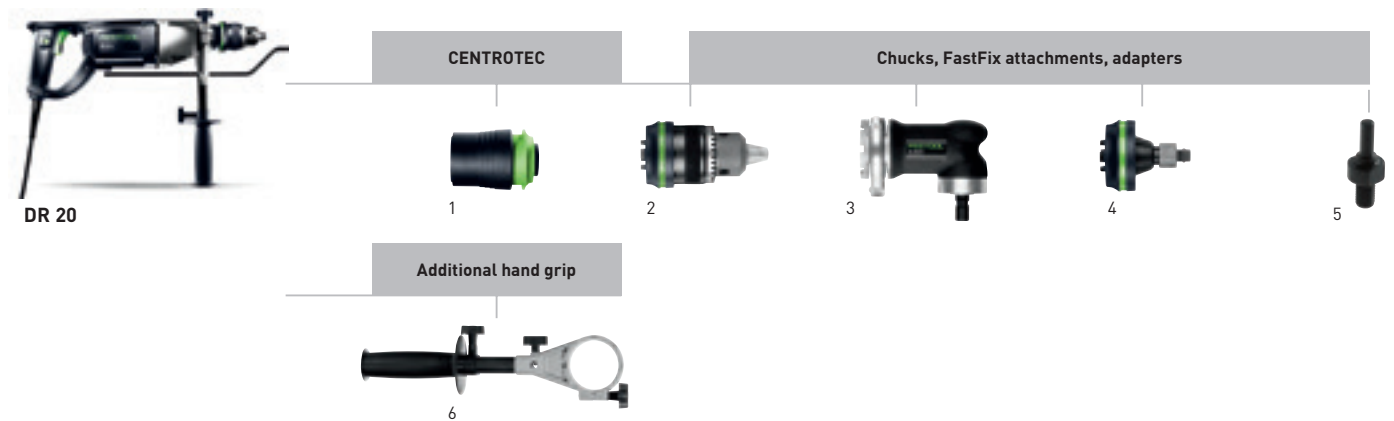

Accessories for QUADRILL DR 20

Denomination	Explanation	Order no.
1 Tool chuck CC-XL CENTROTEC	for DR 20 E FF, DRP 20 ET FF, DRP 20-2 E FF, for holding CENTROTEC tools, holder FastFix, in self-service display pack	769071
2 Key-type chuck CC-16 FFP	for DR 20 E FF, DRP 20 ET FF, DRP 20-2 E FF, with wrench and locking device, holder FastFix, clamping range 3 – 16 mm, in self-service display pack	769061
3 Angle chuck AU DR 20	for DR 20 E FF, DRP 20 ET FF, DRP 20-2 E FF, holder FastFix, collar dia. 57 mm, in self-service display pack	769060
4 Adapter AD-1/2 FF	for DR 20 E FF, DRP 20 ET FF, DRP 20-2 E FF, for quick-change adapters, For holding socket wrenches with 1/2" square, holder FastFix, in self-service display pack	769062
5 Adapter AD-D10/M14	for Festool stirrers: to mount in a drill chuck, for sanding disc with M14 thread: for mounting in drilling and boring machines, for polishing pad Ø 80: for use in cordless drills, clamping flange dia. 10 mm, in self-service display pack	483944
6 Auxiliary handle AH-57/230	for DRP 20, for absorbing higher torques, holder dia. 57 mm, length 230 mm, telescopic design extendible up to 325 mm, in self-service display pack	769044
Auxiliary handle AH-57/275	for DRP 20, for absorbing higher torques, holder dia. 57 mm, length 275 mm, telescopic design extendible up to 380 mm, in self-service display pack	769045

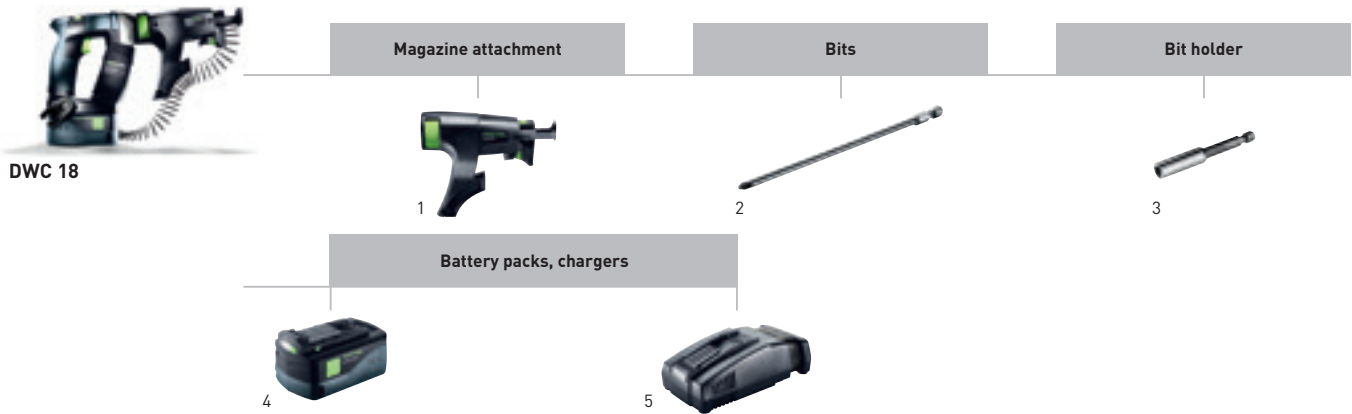



Accessories for cordless drywall screwdrivers DURADRIVE DWC 18

Denomination	Explanation	Order no.
1 Magazine attachment AF 55-DWC	for DWC, DWP, for taped screws, 25-55 mm, bit PH2, long, in carton	769146
2 Bits PH2-AF-55 3x	AF 55-DWP/DWC, size PH 2, length 152 mm, qty. in pack 3 piece(s), in self-service display pack	769124
Bits PZ2-AF-55 3x	AF 55-DWP/DWC, size PZ 2, length 152 mm, qty. in pack 3 piece(s), in self-service display pack	769078
Bits TX 20-AF-55/3	AF 55-DWP/DWC, processing timber construction screws loaded in a magazine (TX 20) with a length of up to 55 mm, long bits for magazine attachment, ideal for DWC 18-2500, length 152 mm, size TX 20, qty. in pack 3 piece(s), in self-service display pack	201463
3 Bit holder BH-DWC	for DWC, DWP, qty. in pack 1 piece(s), in self-service display pack	769125
4 Battery pack BP 18 Li 5,2 AS	with AIRSTREAM function, lithium-ion (Li-ion) replacement battery pack for all Festool 18 V cordless tools (except CXS/TXS, RTSC, DTSC, ETSC), tensioner 18 V, capacity 5,2 Ah, weight 0,7 kg, in self-service display pack	200181
Battery pack BP 18 Li 5,2 AS-ASI	Bluetooth lithium-ion (Li-ion) battery pack with AIRSTREAM function for all Festool 18 V cordless tools (except CXS/TXS, RTSC, DTSC, ETSC), Bluetooth enables the CLEANTEC mobile dust extractor to be started automatically when the cordless tool is switched on (use of the Bluetooth module at the free slot on the CLEANTEC mobile dust extractor is required), tensioner 18 V, capacity 5,2 Ah, weight 0,7 kg, in carton	202479
Battery pack BP 18 Li 6,2 AS-ASI	Bluetooth lithium-ion (Li-ion) battery pack with AIRSTREAM function for all Festool 18 V cordless tools (except CXS/TXS, RTSC, DTSC, ETSC), Bluetooth enables the CLEANTEC mobile dust extractor to be started automatically when the cordless tool is switched on (use of the Bluetooth module at the free slot on the CLEANTEC mobile dust extractor is required), tensioner 18 V, capacity 6,2 Ah, weight 0,7 kg, in carton	201797
Battery pack BP 18 Li 3,1 C	compact, lightweight design, lithium-ion (Li-ion) replacement battery pack for all Festool 18 V cordless tools (except TSC 55, CXS/TXS, RTSC, DTSC, ETSC), tensioner 18 V, capacity 3,1 Ah, weight 0,4 kg, in self-service display pack	201789
5 Rapid charger TCL 6 GB 240V	for all Li-ion battery packs (except for CXS/TXS), Lithium-ion (Li-ion) replacement charger for all 10.8 – 18 V battery packs, charging current 6 A, input voltage 220 – 240 V, weight 0,8 kg, in self-service display pack	201136
Rapid charger SCA 8 GB 240V	for all Li-ion battery packs (except for CXS/TXS), with AIRSTREAM function, Lithium-ion (Li-ion) replacement charger for all 10.8 – 18 V battery packs, charging current 8 A, input voltage 220 – 240 V, weight 1,1 kg, in self-service display pack	200311
Battery and charging technology	from page 10	





Drilling and Fastening

System accessories









25 mm bits

		Type	Order no.
	PZ bit length 25 mm, qty. in pack 10 piece(s), in self-service display pack		
	size PZ 1	PZ 1-25/10	490481
	size PZ 2	PZ 2-25/10	490482
	size PZ 3	PZ 3-25/10	490483
	TX bit length 25 mm, qty. in pack 10 piece(s), in self-service display pack		
	size TX 10	TX 10-25/10	490504
	size TX 15	TX 15-25/10	490505
	size TX 20	TX 20-25/10	490506
	size TX 25	TX 25-25/10	490507
	size TX 30	TX 30-25/10	490508
	twinBOX content 10 pieces, in self-service display pack		
	3 x PZ 1 bit, 4 x bit PZ 2, 3 x PZ 3 bit	BB-PZ	496934
	TX 10 bit, 2 x TX 15 bit, 3 x TX 20 bit, 3 x TX 25 bit, TX 30 bit	BB-TX	496935
	PH 1 bit, PH 2 bit, PZ 1 bit, bit PZ 2, PZ 3 bit, SZ 0.8 x 5.5 bit, TX 15 bit, TX 20 bit, TX 25 bit, TX 30 bit	BB-MIX	496936

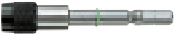



100 mm bits

		Type	Order no.
	Bits length 100 mm, qty. in pack 2 piece(s), in self-service display pack		
	size PZ 1	PZ 1-100 CE/2	500841
	size PZ 2	PZ 2-100 CE/2	500842
	size PZ 3	PZ 3-100 CE/2	500843
	Bits length 100 mm, qty. in pack 2 piece(s), in self-service display pack		
	size PH 1	PH 1-100 CE/2	500844
	size PH 2	PH 2-100 CE/2	500845
	size PH 3	PH 3-100 CE/2	500846
	Bits length 100 mm, qty. in pack 2 piece(s), in self-service display pack		
	size SZ 0,8 x 5,5	SZ 0,8x5,5-100 CE/2	500852
	size SZ 1,2 x 6,5	SZ 1,2x6,5-100 CE/2	500851
	Bits length 100 mm, qty. in pack 2 piece(s), in self-service display pack		
	size TX 15	TX 15-100 CE/2	500847
	size TX 20	TX 20-100 CE/2	500848
	size TX 25	TX 25-100 CE/2	500849
	size TX 30	TX 30-100 CE/2	500850
	Bits for SYS TL with lid compartment, 6 CENTROTEC bits: PZ 2-100 CE, PZ 3-100 CE, TX 15-100 CE, TX 20-100 CE, TX 25-100 CE, TX 30-100 CE, length 100 mm, qty. in pack 6 piece(s), in self-service display pack	CENTROTEC BITS CE SET TL 6X	769095

Bits and bit holders

	Type	Order no.
 <p>Bit box for all Festool cordless drills with FastFix interface, CENTROTEC magnetic bit fastener BH 60 CE, content 10 pieces, in self-service display pack</p>		
2 x PZ 1 bit, 5 x bit PZ 2, 2 x PZ 3 bit	PZ + BH 60-CE	493260
TX 10 bit, 2 x TX 15 bit, 3 x TX 20 bit, 2 x TX 25 bit, TX 30 bit	TX + BH 60-CE	493261
PH 1 bit, PH 2 bit, PZ 1 bit, bit PZ 2, PZ 3 bit, SZ 0.8 x 5.5 bit, TX 15 bit, TX 20 bit, TX 25 bit	MIX + BH 60-CE	493262
 <p>Bit assortment for SYS TL with lid compartment, 24-piece, 2 x PH 1 bit, 2 x PH 3, 2 x TX 10 bit, 2 x PH 2 bit, 2 x PZ 1 bit, 2 x bit PZ 2, 2 x PZ 3 bit, 2 x TX 15 bit, 2 x TX 20 bit, 2 x TX 25 bit, 2 x TX 30 bit, 2 x TX 40 bit, Quick change bit holder, in self-service display pack</p>	BITS + BHS 65 CE TL 24x	769094
 <p>Bit holder for all Festool cordless drills with FastFix interface, qty. in pack 1 piece(s), in self-service display pack</p>	BHS 65 CE	492648
 <p>Bit holder for all Festool cordless drills with FastFix interface, also suitable for use with impact screwdriver TI15 Impact, qty. in pack 1 piece(s), in self-service display pack</p>	BH 60 CE-Imp	498974
 <p>Bit holder for all Festool cordless drills with FastFix interface, extra-long, qty. in pack 1 piece(s), in self-service display pack</p>	BV 150 CE	492540
<p>Adapter for all Festool cordless drills with FastFix interface, for plug-in bits, with ball lock for manual operation, qty. in pack 1 piece(s), in self-service display pack</p>		
 <p>holder 1/4", length 50 mm</p>	1/4"-50 CE/KG CENTROTEC	495131
 <p>holder 3/8", length 70 mm</p>	3/8"-70 CE/KG CENTROTEC	495133
 <p>Screwdriver for CENTROTEC tools for drilling and screwdriving, in self-service display pack</p>	SD-CE-DRIVE-UNI	200140



Bit cassette

	Type	Order no.
 <p>Bit cassette 31-piece, 1 magnetic bit holder 1/4", in self-service display pack</p>		
3 x TX 10 bit, 3 x TX 15 bit, 6 x TX 20 bit, 6 x TX 25 bit, 6 x TX 30 bit, 3 x TX 40 bit, 3 x TX 50	TX 10-50/BH-SORT/31x	769137
 <p>1x LS 4,5; LS 5,5; LS 6,5; HEX 4; HEX 5; HEX 6, 2 x TX 10 bit, 2 x TX 15 bit, 2 x TX 20 bit, 2 x TX 25 bit, 2 x TX 30 bit, 2 x TX 40 bit, 2 x PH 1 bit, 2 x PH 2 bit, 2 x PH 3, 2 x PZ 1 bit, 2 x bit PZ 2, 2 x PZ 3 bit</p>	BIT/BH-SORT/31x	769138
 <p>Ratchet set 1/4" socket set from 4.0 to 13 mm, 19 different bit inserts and 2 bit extensions, ratchet and CENTROTEC handle plus various adapters and extensions, in SYSTAINER SYS MINI</p>	1/4"-CE RA-Set 36	497881
 <p>Assembly package for all Festool cordless drills with FastFix interface, CENTROTEC-DRIVE screwdriver handle, CENTROTEC tool chuck, CENTROTEC magnetic bit fastener BH 60 CE, extra-long CENTROTEC magnetic bit holder BV 150 CE, CENTROTEC drill adapter BA-CE, deburring countersink QLS D2-8 CE, deburring countersink QLS D5-15 CE, BTA HW D5 CE drill bit with depth stop, drill countersink with depth stop, BSTA HS D3.5 CE, centering bit ZB HS D5 EURO CE, hook driver HD D18 CE, twinBOX BB-MIX range of bits, drill bit case HSS D3-10 CE/10, drill bit case BKS D3-8 CE/W-K, 12x long CENTROTEC bits PZ/PH/TX, bit assortment 25 mm, 50 pieces, in SYSTAINER SYS 1 T-LOC</p>	SYS 1 CE-SORT	497628

Drilling and Fastening

System accessories

CENTROTEC HSS twist drill bit

	Type	Order no.
	Twist drill bit in self-service display pack	
complete drill bit with bit holder and 2 replacement drill bits, hexagon socket wrench, diameter 3 mm, qty. in pack 1 piece(s)	HSS D 3/33 CE/M-Set	493421
complete drill bit with bit holder and 2 replacement drill bits, hexagon socket wrench, diameter 3,5 mm, qty. in pack 1 piece(s)	HSS D 3,5/39 CE/M-Set	493422
complete drill bit with bit holder and 2 replacement drill bits, hexagon socket wrench, diameter 4 mm, qty. in pack 1 piece(s)	HSS D 4/43 CE/M-Set	493423
complete drill bit with bit holder and 2 replacement drill bits, hexagon socket wrench, diameter 4,5 mm, qty. in pack 1 piece(s)	HSS D 4,5/47 CE/M-Set	493424
complete drill bit with bit holder and 2 replacement drill bits, hexagon socket wrench, diameter 5 mm, qty. in pack 1 piece(s)	HSS D 5/52 CE/M-Set	493425
complete drill bit with bit holder and 2 replacement drill bits, hexagon socket wrench, diameter 5,5 mm, qty. in pack 1 piece(s)	HSS D 5,5/57 CE/M-Set	493426
complete drill bit with bit holder and 2 replacement drill bits, hexagon socket wrench, diameter 6 mm, qty. in pack 1 piece(s)	HSS D 6/57 CE/M-Set	493427
complete drill bit with bit holder and 2 replacement drill bits, hexagon socket wrench, diameter 6,5 mm, qty. in pack 1 piece(s)	HSS D 6,5/63 CE/M-Set	493428
complete drill bit with bit holder and 1 replacement drill bit, hexagon socket wrench, diameter 8 mm, qty. in pack 1 piece(s)	HSS D 8,0/75 CE/M-Set	495308
complete drill bit with bit holder and 1 replacement drill bit, hexagon socket wrench, diameter 10 mm, qty. in pack 1 piece(s)	HSS D 10,0/75 CE/M-Set	495309
	Drill bit case, diameter 3 – 10 mm, qty. in pack 10 piece(s)	HSS D3-10 CE/10
	spare part drill bit for CENTROTEC M Set twist drill bit, diameter 3 mm, qty. in pack 10 piece(s)	HSS D 3/33 M/10
spare part drill bit for CENTROTEC M Set twist drill bit, diameter 3,5 mm, qty. in pack 10 piece(s)	HSS D 3,5/39 M/10	493438
spare part drill bit for CENTROTEC M Set twist drill bit, diameter 4 mm, qty. in pack 10 piece(s)	HSS D 4/43 M/10	493439
spare part drill bit for CENTROTEC M Set twist drill bit, diameter 4,5 mm, qty. in pack 10 piece(s)	HSS D 4,5/47 M/10	493440
spare part drill bit for CENTROTEC M Set twist drill bit, diameter 5 mm, qty. in pack 10 piece(s)	HSS D 5/52 M/10	493441
spare part drill bit for CENTROTEC M Set twist drill bit, diameter 5,5 mm, qty. in pack 10 piece(s)	HSS D 5,5/57 M/10	493442
spare part drill bit for CENTROTEC M Set twist drill bit, diameter 6 mm, qty. in pack 10 piece(s)	HSS D 6/57 M/10	493443
spare part drill bit for CENTROTEC M Set twist drill bit, diameter 6,5 mm, qty. in pack 10 piece(s)	HSS D 6,5/63 M/10	493444
spare part drill bit for CENTROTEC M Set twist drill bit, diameter 8 mm, qty. in pack 5 piece(s)	HSS D 8,0/75 M/5	495310
spare part drill bit for CENTROTEC M Set twist drill bit, diameter 10 mm, qty. in pack 5 piece(s)	HSS D 10,0/75 M/5	495311



HSS steel drill

	Type	Order no.
	Drill bit box for HSS steel drill bits Drill bit case, diameter 1-10 mm, qty. in pack 19 piece(s), in self-service display pack	HSS D 1-10 Sort/19

Drill bit

		Type	Order no.
	Drill bit for all Festool cordless drills with FastFix interface, qty. in pack 1 piece(s), in self-service display pack		
	diameter 3 mm	D 3 CE/W	492512
	diameter 4 mm	D 4 CE/W	492513
	diameter 5 mm	D 5 CE/W	492514
	diameter 6 mm	D 6 CE/W	492515
	diameter 7 mm	D 7 CE/W	492516
	diameter 8 mm	D 8 CE/W	492517
	diameter 10 mm	D 10 CE/W	492518
	Drill bit 6 CENTROTEC wood twist drills, diameter 4, 2 x 5, 6, 8, 10 mm, qty. in pack 6 piece(s), in self-service display pack	DB WOOD CE SET TL 6x	769093
	Drill bit case long drill bit case, with brad point, diameter 3, 4, 5, 6, 8 mm, qty. in pack 5 piece(s), in self-service display pack	BKS D 3-8 CE/W	493648
	Drill bit case short drill bit case, with brad point, qty. in pack 5 piece(s), diameter 3, 4, 5, 6, 8 mm, in self-service display pack	BKS D 3-8 CE/W-K	495130



CENTROTEC masonry drills with carbide-tipped cutter

		Type	Order no.
	Masonry drill in self-service display pack		
	diameter 4 mm, qty. in pack 3 piece(s)	DB STONE CE D4 3x	769111
	diameter 5 mm, qty. in pack 3 piece(s)	DB STONE CE D5 3x	769112
	diameter 6 mm, qty. in pack 3 piece(s)	DB STONE CE D6 3x	769113
	diameter 8 mm, qty. in pack 3 piece(s)	DB STONE CE D8 3x	769114
	diameter 10 mm, qty. in pack 3 piece(s)	DB STONE CE D10 3x	769115
	for SYS TL with lid compartment, 6 CENTROTEC masonry drill bits: dia. 4, 5, 2 x 6, 8, 10 mm, qty. in pack 1 piece(s)	DB STONE CE SET TL 6x	769096

Drilling and Fastening

System accessories



CENTROTEC Forstner drill bit system ZOBO

		Type	Order no.
	Forstner drill bit, ZOBO system qty. in pack 1 piece(s), in self-service display pack diameter 15 mm	FB D 15 CE-Zobo	496472
	diameter 20 mm	FB D 20 CE-Zobo	496473
	diameter 25 mm	FB D 25 CE-Zobo	496474
	diameter 30 mm	FB D 30 CE-Zobo	496475
	diameter 35 mm	FB D 35 CE-Zobo	496476
	Drill bit set, ZOBO system Sturdy plastic drill bit case, Forstner drill bit, ZOBO system FB D 15 CE-Zobo, Forstner drill bit, ZOBO system FB D 20 CE-Zobo, Forstner drill bit, ZOBO system FB D 25 CE-Zobo, Forstner drill bit, ZOBO system FB D 30 CE-Zobo, Forstner drill bit, ZOBO system FB D 35 CE-Zobo, diameter 15 – 35 mm, qty. in pack 5 piece(s), in self-service display pack	FB Set D 15-35 CE-Zobo	496390
	Spare part set ZOBO centre points (FB-CE 2.5x3.5/ZS and FB-CE 2.5x7.5/ZS), centring bit (FB-CE 3x30/ZB) and punch (FB-Set-D 15-35 CE), for CENTROTEC Forstner drill bit, in self-service display pack	FB-CE/Er-Zobo	497268

CENTROTEC other accessoires

		Type	Order no.
	Deburring countersink qty. in pack 1 piece(s), in self-service display pack diameter 2 – 8 mm	QLS D 2- 8 CE	492520
	for pre-counterboring and flush screwing, diameter 5 – 15 mm	QLS D 5-15 CE	492521
	Drill bit with depth stop carbide, adjustable depth stop, diameter 5 mm, qty. in pack 1 piece(s), in self-service display pack	BTA HW D 5 CE	492522
	Spare part drill bit for drill bit with depth stop, carbide, diameter 5 mm, qty. in pack 1 piece(s), in self-service display pack	HW D 5 F.BTA	491794
	Drill countersink with depth stop adjustable depth stop, diameter 3,5 mm, qty. in pack 1 piece(s), in self-service display pack	BSTA HS D 3,5 CE	492523
	Spare part drill bit for drill countersink with depth stop, diameter 3,5 mm, qty. in pack 5 piece(s), in self-service display pack	EB-BSTA D 3,5/5	494445
	Drill countersink with depth stop adjustable depth stop, diameter 4,5 mm, qty. in pack 1 piece(s), in self-service display pack	BSTA HS D 4,5 CE	492524
	Spare part drill bit for drill countersink with depth stop, diameter 4,5 mm, qty. in pack 5 piece(s), in self-service display pack	EB-BSTA D 4,5/5	494446
	Drill countersink with depth stop adjustable depth stop, diameter 5 mm, qty. in pack 1 piece(s), in self-service display pack	BSTA HS D 5 CE	496451
	Spare part drill bit for drill countersink with depth stop, diameter 5 mm, qty. in pack 5 piece(s), in self-service display pack	EB-BSTA D 5/5	496452
	Centering bit with depth stop for 5 mm Euro-screws, diameter 5 mm, qty. in pack 1 piece(s), in self-service display pack	ZB HS D 5 EURO CE	492525
	Spare part drill bit for centring bits, diameter 5 mm, qty. in pack 1 piece(s), in self-service display pack	HS D 5	493572
	Hook driver for all Festool cordless drills with FastFix interface, diameter 18 mm, qty. in pack 1 piece(s), in self-service display pack	HD D 18 CE	492526
	Drill adapter qty. in pack 1 piece(s), in self-service display pack	BA-CE CENTROTEC	496450
	Drill countersink with depth stop adjustable depth stop, especially designed for machining patio flooring, diameter 4 mm, max. drill depth 60 mm, qty. in pack 1 piece(s), in self-service display pack	BSTA HS D 4 L60 CE	202392
	Long-life spare part drill bit for drill countersink with depth stop, extremely long service life because the drill bit is made of high-quality HSS Böhler steel, diameter 4 mm, max. drill depth 60 mm, qty. in pack 2 piece(s), in self-service display pack	EB-BSTA D 4/2x	202393

Drilling guide systems

		Type	Order no.
	Drill stand for carpentry for powerful drills, easy movement thanks to precise guide rods and bronze slide bearing in the guide block, positive stability due to the square base plate with precision-milled supporting surface, Centering plate for drill bits Ø 8 to 26 mm, 2 x depth stop, 2 x parallel side fence, Adapter ring Ø 57 mm / 43 mm, in carton		
	max. drill depth 240 mm, max. drill bit length 320 mm, weight 2,8 kg	GD 320	768768
	max. drill depth 380 mm, max. drill bit length 460 mm, weight 3,2 kg	GD 460	768119
	swivel-mounted, max. drill depth 310 mm, max. drill bit length 460 mm, weight 3,7 kg	GD 460 A	769042
	Staircase drilling system for mains-operated drills and powerful cordless screwdrivers, precise hole depth due to adjustable depth gauge, The drills are fitted and removed very quickly due to the bayonet lock function, clamp, adapter for the staircase bits with the 9 mm Ø shank, gauge ring, insert for the angular frame, adapter plate, open-end spanner SW8 and SW10, pin key SW3, staircase bits Ø 18-20-22-25-30 mm, 1 ejector rod, 2 x Centring point CP-WD 2,5 x 3,5, CP-WD 2,5x7,7, CP-WD 2,5x14,7, drill bit dia. 10 – 40 mm, in SYSTAINER SYS 1 T-LOC	GD D10-40 A Set	768098

Accessories for drywall screwdriver DWC

		Type	Order no.
	Drywall screws AF 55-DWP/DWC, diameter 3,9 mm, in carton		
	magazine-loaded, 1000 pc. fine thread, length 25 mm	DWS C FT 3,9x25 1000x	769142
	magazine-loaded, 1000 pc. fine thread, length 35 mm	DWS C FT 3,9x35 1000x	769143
	magazine-loaded, 1000 pc. coarse thread, length 35 mm	DWS C CT 3,9x35 1000x	769144
	magazine-loaded, 1000 pc. coarse thread, length 45 mm	DWS C CT 3,9x45 1000x	769145



Routing

Overview of products and applications	246
Routers OF 1010, OF 1400, OF 2200, CMS-OF	248
Bench-mounted routers TF 1400, TF 2200	253
Multi-routing templates MFS 400, MFS 700	254
Worktop template APS	255
Jointing system VS 600 GE	256
Hole series system LR 32	257
Edging system OF-FH 2200	258
Edge routers OFK 500, OFK 700	259
Module edge router MFK 700	261
Aluminium composite milling machine PF 1200	262
Chain mortiser CM 150	263
Accessories and consumable materials	264
The Festool system	

Routing

Overview of products and applications

Rounding off corners, routing cut-outs, profiling – tasks best performed using a perfectly adapted range of routers and laminate trimmers.

Page 248 — 249 — 250 — 253 — 253

OF 1010

OF 1400

OF 2200

TF 1400

TF 2200



Applications

Routers

Bench-mounted routers

Routing cut-outs and circles with MFS

Worktop corner joints with APS

Routing corner joints with VS 600

Use with the hole series system

Routing shapes using a template

Routing small curves and profiles

Routing large curves and profiles

Routing joins, rebates and grooves

Processing mineral materials

Routing edge veneer flush with straight workpieces

Routing edge veneer flush on curved workpieces

Flush-routing of laminate

Routing accurate grooves in aluminium composite panels

Making mortises up to 150 mm

Technical data

	1.010	1.400	2.200	1.400	2.200
Power consumption (W)	10.000 – 24.000	10.000 – 22.500	10.000 – 22.000	10.000 – 22.5000	10.000 – 22.000
Idle engine speed (rpm)	6 – 8	6 – 12,7	6 – 12,7		
Collets Ø (mm)	55	70	80		
Routing depth adjustment range (mm)	8	8	20		
Fine height adjustment range (mm)	50	63	89	60	60
Max. cutter Ø (mm)	27	27/36	36/27	27/36	27/36
Connection Ø d/e (mm)				585 x 400	585 x 400
Table dimensions [mm]					
Mortising depth (mm)					
Speed of chain sprocket (rpm)					
Weight (kg)	2,7	4,5	7,8	25,4	29,4

259 ——— 260 ——— 261 ——— 262 ——— 263

OFK 500

OFK 700

MFK 700

PF 1200

CM 150



Edge routers

**Aluminium
composite milling
machines**

Chain mortiser

06



**Extremely
appropriate**

Appropriate

	450	720	720	1.200	2.000
	28.000	10.000 – 26.000	10.000 – 26.000	1.900 – 5.200	
		6 – 8	6 – 8		
			14		
	28	26	32	118	
	27	27	27	27/36	
					100/150
					4.250
	1,4	2,0	1,9	5,4	8,5

Routing

Router OF 1010

OF 1010



A host of features for perfect working results.

Whether guided independently or on the guide rail, the OF 1010 is the perfect one-handed router. Compact and lightweight, you can guide it accurately along edges, lines or curves, using only one hand.



Small tool for delicate tasks.

- ▶ Outstanding ergonomics and low weight
- ▶ Handle for easy one-handed operation
- ▶ Spindle stop for easy cutter changes
- ▶ Quick-acting brake for improved safety (OF 1010 EBQ)

Technical data

Power consumption (W)	1.010
Idle engine speed (min ⁻¹)	10.000 – 24.000
Collet dia. (mm)	6 – 8
Routing stroke (mm)	55
Routing depth fine adjustment range (mm)	8
Max. cutter diameter (mm)	50
Dust extraction connection dia. (mm)	27
Weight (kg)	2,7

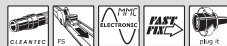

= MMC Multi Material Control electronics

Items included

Ø 1/4" clamping collet (6.35 mm), chip deflector, side stop, guide rail adapter, operation tool, in SYSTAINER SYS 3 T-LOC

OF 1010 EBQ-Plus GB 240V

Order no.

574334

OF 1010 EQ-Plus GB 110V

Ø 8 mm clamping collet

574338

OF 1010 EBQ-Set GB 240V

guide rail FS 800/2

574374

OF 1010 EQ-Set GB 110V

Ø 8 mm clamping collet, guide rail FS 800/2

574377

System accessories
from page 266



Router tools
from page 277





OF 1400



Power and ease of operation in perfect harmony.

- ▶ Pure precision: rigid base plate due to guide columns on both sides
- ▶ Short set-up times: Rocker and ratchet principle for convenient cutter changes
- ▶ Routing depth adjustment to 1/10 mm
- ▶ Quick-acting brake and MMC electronics

Technical data

Power consumption [W]	1.400
Idle engine speed [min ⁻¹]	10.000 – 22.500
Collet dia. [mm]	6 – 12,7
Routing stroke [mm]	70
Routing depth fine adjustment range [mm]	8
Max. cutter diameter [mm]	63
Dust extraction connection dia. [mm]	27/36
Weight [kg]	4,5



■ = MMC Multi Material Control electronics

Items included

chip deflector, Ø 1/4" clamping collet (6.35 mm), Ø 1/2" clamping collet (12.7 mm), side stop with fine setting, copying ring Ø 30 mm, extraction hood, top, operation tool, in SYSTAINER SYS 4 T-LOC

Order no.

OF 1400 EQ-Plus GB 110V 574344

OF 1400 EBQ-Plus GB 240V 574345

An impressive all-in-one package.

At 4.5 kg, the OF 1400 is the lightest in its class and has an impressive 70 mm routing depth adjustment range. This is particularly useful when making recesses for fittings or routing with templates.

**System accessories
from page 268**



**Router tools
from page 277**



Routing

Router OF 2200



OF 2200



Unrivalled performance and operation.

More powerful, easier to use, increased comfort and safer – the OF 2200 offers the greatest low-end torque, the highest precision and the greatest ergonomic comfort. No matter what your task is – with the OF 2200, you have the solution in your hands.

The power pack with enormous torque.

- ▶ Top power development and fully variable speed for hard materials and increased material thicknesses
- ▶ Outstanding ergonomics: guide rods offset by 30 degrees to transfer force efficiently
- ▶ Dual guide column clamp for extra torsional rigidity and greater precision
- ▶ Maximum safety: safety brake stops the cutter promptly

Technical data

Power consumption (W)	2.200
Idle engine speed (min ⁻¹)	10.000 – 22.000
Collet dia. (mm)	6 – 12,7
Routing stroke (mm)	80
Routing depth fine adjustment range (mm)	20
Max. cutter diameter (mm)	89
Dust extraction connection dia. (mm)	36/27
Weight (kg)	7,8



= MMC Multi Material Control electronics

Items included	Order no.
Ø 1/4" clamping collet (6.35 mm), Ø 1/2" clamping collet (12.7 mm), copying ring Ø 30 mm, chip deflector, operation tool, in SYSTAINER SYS 4 T-LOC	
OF 2200 EB-Plus GB 240V	574352
OF 2200 EB-Plus GB 110V	574353
OF 2200 EB-Set GB 240V	574395
accessories SYSTAINER (Order No. 497655)	
OF 2200 EB-Set GB 110V	574396
accessories SYSTAINER (Order No. 497655)	

System accessories
from page 269



Router tools
from page 277





Adapted to the task in hand.

Festool offers a compatible range of routers and laminate trimmers for every task. A range that not only includes tools, but also a wide selection of ingenious system accessories. Interchangeable copying rings and base runners, for example, allow you to adapt your machine to changing task requirements. Multifunctional routing templates can be adjusted to any dimension both quickly and accurately, while routers OF 1010, 1400 and 2200 can be converted into bench-mounted routers. All of these solutions were developed following close collaboration with the handicraft trade – bringing you closer to the perfect result with greater speed and efficiency.

06

Quick response to changing requirements.

Base runners and copying rings for the OF 1400/OF 2200 can be replaced quickly using FastFix without requiring tools. Changing router bits is also a simple matter, thanks to the ratcheting mechanism, which allows you to either tighten or release the router bit without having to turn the open ended spanner.



Cleaner, healthier work.

The new suction design behind the OF 2200 ensures suction power of up to 99%. The retractable extractor ring seals off the chip space when the router is used in plunge mode. However, the ring can be locked in place on top for a perfect view of the scribe mark. The chip deflector can be rotated 360° and ensures maximum suction power.

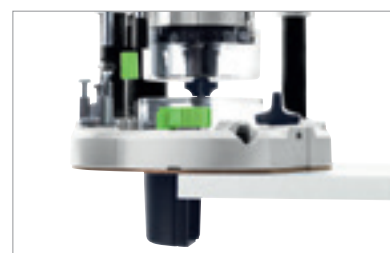

Impeccable guidance.

The guide rail was invented and perfected by Festool. For enhanced precision of grooves and rows of holes. Fitted with slideway lining to allow machines to glide smoothly along the rail, plus a groove for fastening and lever clamps.



Routing

Module mounting CMS-OF



CMS-OF



From mobile to stationary in a matter of seconds.

With the CMS module, standard routers can be transformed into bench-mounted routers suitable for a wide range of applications. The transparent routing guard guarantees efficient dust extraction while also providing a good view of the workpiece.

Router for the CMS system.

- ▶ Module mounting for installing routers
- ▶ The router can be used not only as a bench-mounted tool, but also as a handheld tool
- ▶ Simple routing height adjustment with a crank handle
- ▶ Flexible extension options – for an even wider range of applications

Technical data

Max. cutter diameter (mm)	60
Dimensions (mm)	578 x 320
Weight (kg)	10,1

Items included	Order no.
CMS-OF assembly lugs, router stop, press-down fixture, guard, in carton	570251

CMS system overview
from page 396



System accessories
from page 414





TF 1400 / TF 2200

The system bench-mounted router.

- ▶ Complete set consisting of a basic unit, module mounting and router
- ▶ The router can be used not only as a bench-mounted tool, but also as a handheld tool
- ▶ Simple routing height adjustment with a crank handle
- ▶ Flexible extension options – for an even wider range of applications

Technical data	TF 1400	TF 2200
Power consumption [W]	1.400	2.200
Idle engine speed [min ⁻¹]	10.000 – 22.500	10.000 – 22.000
Max. cutter diameter [mm]	60	60
Table dimensions [mm]	585 x 400	585 x 400
Dimensions module support [mm]	578 x 320	578 x 320
Table height, legs unfolded [mm]	900	900
Table height, legs folded away [mm]	316	316
Working height with legs [mm]	900	900
Dust extraction connection dia. [mm]	27/36	27/36
Basic unit weight [kg]	10,8	10,8
Weight [set] [kg]	25,4	29,4



■ = MMC Multi Material Control electronics



Comfortable routing of conventional profiles.

Low space requirements combined with powerful and precise performance make the bench-mounted router ideal for series production. The extensive range of shank cutters with varying geometries enable you to process strips, profiles and medium to large workpieces in a professional manner.

System accessories
from page 414



Router tools
from page 277

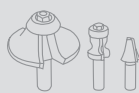

Routing

The MFS routing template



MFS

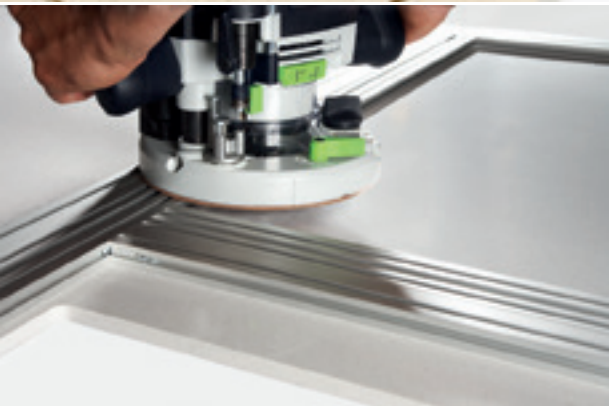

A multi-talent.

The laborious manufacture of templates or temporary solutions has become a thing of the past: the MFS multi-routing template is versatile and perfect for curves, round or square cut-outs and routing staircase stringers.

The template with all the options.

- ▶ Scale on the profiles accurate to the millimetre for absolute precision when making cut-outs and curves
- ▶ Aligned exactly with the workpiece – via the angle stops
- ▶ Secured quickly – workpiece secured in prefabricated groove for fastening and lever clamps
- ▶ Option of systematic extension – with table extensions from 200 mm to 2000 mm

Technical data

Dimensions length x width (mm)	300 x 100
Curves (mm)	40 – 600

Items included	Order no.
2 x angle stop, tilt protection, circle routing insert, operation tool, in carton	
MFS 400	492610
MFS 700	492611

System accessories
from page 271



Router tools
from page 277





Precision as standard.

- ▶ For corner and panel joints up to 900 mm deep
- ▶ For routing normal connection fittings on the undersides of panels
- ▶ Panel widths greater than 900 mm also possible using extension profiles

Items included

APS 900
corner connection template, profile MFS-VP 1000, 3 x Bolt, operation tool,
in carton

Order no.

492727

Flush joints.

Clean corner and panel joints are easy to manufacture with the worktop template. The permanently fixed template guarantees precision results, even when the router passes several times along a single groove.

Router tools
from page 277



Routing

Joining system VS 600

VS 600 GE



Eternal precision.

The joining system VS 600 is an exceptionally logical method of achieving perfect woodworking results. Offering outstanding precision for partially covered and open dovetail joints, box joints and custom-fit dowelling joints.



Combining tradition with efficiency.

- ▶ Perfection in a system: router, template and copying ring are fully compatible with one another
- ▶ Wide application spectrum: from dovetail joints and box joints to dowelling joints
- ▶ Templates changed quickly and easily without using tools
- ▶ Robust aluminium design and steel contact jaws ensure an extended service life

Technical data

Workpiece thickness (depending on join) (mm)	6 - 29
Max. workpiece width (mm)	600

Items included

VS 600 GE
in carton

Order no.

488876

A routing template and a suitable router are required to use the VS 600 GE joining system.

Routing templates
from page 272



Router tools
from page 277



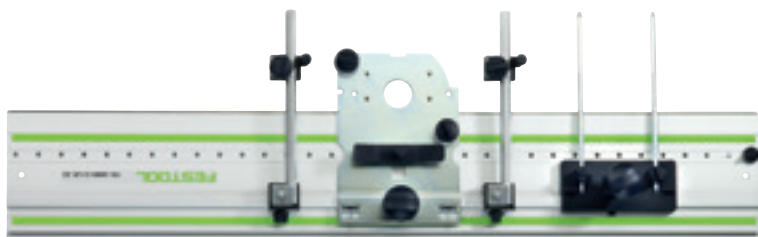

LR 32



Holes in series.

- ▶ With the LR 32 system – comprising the guide rail FS 1400/2-LR 32 or FS 2424/2-LR 32 and the hole drilling system – precise rows of holes spaced 32 mm apart can be drilled with the Festool router
- ▶ The LR 32 guide rail is aligned quickly and parallel to the two side stops, which are positioned by means of an adjustable stop at the workpiece and guide rail

Items included	Order no.
guide plate, centring mandrel, 2 x Longitudinal stop	
LR 32 Set 2 x side stop, in carton	583290
LR 32-SYS operation tool, hinge location cutter HM Ø 35 mm, dowel drill HW Ø 5 mm (V-shaped tip), dowel drill HM Ø 5 mm (with centring bit and pre-cutter), 2 parallel side fences with adjustable stop, clamp FSZ 120, in SYSTAINER SYS 1 T-LOC	584100

Precise hole rows with the guide rail.

Series of holes must agree in terms of distance and parallelism. To save time when carrying out this type of work, there is the hole row guide rail. It has a series of holes set 32 mm apart, along which the router is guided with the hole row adapter. Thanks to the clever tipping method, the detent pin can be quickly indexed for the next hole. The series of holes are therefore very easy to copy.

System accessories
from page 273

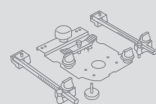

Routing

Edge trimming system OF-FH 2200



OF-FH 2200



Routing door seals.

The grooving of doors is often still considered as a task for bench-mounted routers. With the Festool routing aid and the router, the work can be carried out on site achieving results which are not inferior to those of bench-mounted routers. And thanks to the integral dust extraction, the environment also remains free of wood dust.

Safe, precise routing of seal slots.

- ▶ For secure guidance of the Festool router along narrow workpiece edges
- ▶ Side stops can be adjusted 60 mm on both sides with long guidance areas
- ▶ High-quality cutter device made from sturdy and solid acrylic glass
- ▶ Used, for example, for the reliable milling of automatic door seals

Items included	Order no.
OF-FH 2200 in carton	495246

System accessories from page 273

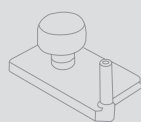



Compact edging professional.

- ▶ Routing depth adjustment to 1/10 mm
- ▶ Perfect adaptation of cutter to borehole in bench to prevent routing errors
- ▶ Stable connection between cutter and drive mechanism for maximum true-running precision
- ▶ Spindle stop for quick and easy cutter changes

Technical data

Power consumption (W)	450
Idle engine speed (min ⁻¹)	28.000
Max. cutter diameter (mm)	28
Dust extraction connection dia. (mm)	27
Weight (kg)	1,4



Items included

OFK 500 Q-Plus R3 GB 240V
ogee cutter HW R3-OFK, extraction hood, in SYSTAINER SYS 2 T-LOC

Order no.

574358

For trimming round objects.

The OFK 500 is particularly lightweight and perfectly balanced, making it manoeuvrable and ideal for both vertical and horizontal use. The small distance between the cutter and router base prevents the machine from tipping over edges, guaranteeing perfect results.

System accessories from page 274



Router tools from page 277



Routing

Edge router OFK 700



OFK 700



Impressive both on curves and in straight lines.

The OFK 700 EQ is a multi-talent among edge trimmers because it makes easy work of trimming edges and surface projections, irrespective of whether the workpiece is large or small, or whether the edges are curved or straight. The quick, heavy-duty detachable router table provides a stable surface area and secure guidance for the machine in any working position.

Edging multi-talent.

- ▶ Detachable router table with large support surface
- ▶ Base inclined by 1.5° for excellent working results
- ▶ Routing depth adjustment to 1/10 mm
- ▶ Contact spring for smooth routing pattern

Technical data

Power consumption (W)	720
Idle engine speed (min ⁻¹)	10.000 – 26.000
Max. cutter diameter (mm)	26
Collet dia. (mm)	6 – 8
Max. cutting depth, vertical (1.5° table) (mm)	9
Max. cutting depth, horizontal (1.5° table) (mm)	5
Max. routing width (mm)	14
Dust extraction connection dia. (mm)	27
Weight (kg)	2



= MMC Multi Material Control electronics

Items included

OFK 700 EQ-Plus GB 240V
Ø 1/4" clamping collet (6.35 mm), extraction hood,
edge trimming cutter D 19 x 16, Ø 8 mm clamping collet, operation tool,
in SYSTAINER SYS 2 T-LOC

Order no.

574362

System accessories from page 274



Router tools from page 277





MFK 700



06



Versatile when trimming edges.

- ▶ Wider application spectrum due to interchangeable router tables
- ▶ Efficient dust extraction integrated directly on the router base
- ▶ Contact spring for smooth routing pattern
- ▶ 130 mm table support surface for accurate routing results

Technical data

Power consumption (W)	720
Idle engine speed (min ⁻¹)	10.000 – 26.000
Collet dia. (mm)	6 – 8
Routing depth fine adjustment range (mm)	14
Max. cutter diameter (mm)	32
Dust extraction connection dia. (mm)	27
Weight (kg)	1,9



■ = MMC Multi Material Control electronics

Items included	Order no.
Ø 1/4" clamping collet (6.35 mm), Ø 8 mm clamping collet, operation tool, in SYSTAINER SYS 2 T-LOC	
MFK 700 EQ/B-Plus GB 240V with ball bearing brake and chip deflector	574455
MFK 700 EQ-Set GB 240V 1.5° router table, parallel side fence with fine adjustment and extraction hood, extraction hood	574366
MFK 700 EQ-Set GB 110V 1.5° router table, parallel side fence with fine adjustment and extraction hood, extraction hood	574365

The end of the perfect edge.

The MFK 700 EQ/B-Plus module edge router with special base for flush trimming edge strips – even on edges cut at 45°. Thanks to the newly developed ball bearing brake with integrated chip deflector, it operates cleanly and efficiently without streaks.

System accessories from page 274



Router tools from page 277



Routing

Aluminium composite milling machine PF 1200

PF 1200

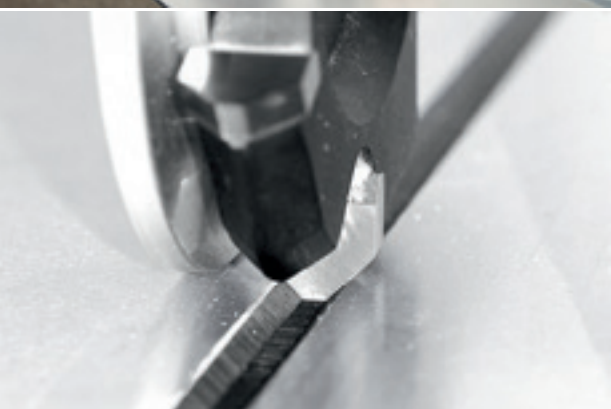

Grooving. Edging. Finished.

Specially developed for edging aluminium composite panels with speed and precision. In combination with the guide rail, the PF 1200 aluminium composite milling machine is ideal for mobile exhibition and façade construction applications. The feeler roller ensures precise routing depths. The router can only plunge into the material as far as the feeler roller allows.



The professional solution for aluminium composite panels.

- ▶ Removable feeder roller for different material thicknesses
- ▶ Low weight for easy transportation and mobile applications
- ▶ Guide slot for guide rail
- ▶ Blade cutter for rapid progress and effortless precision routing

Technical data

Power consumption (W)	1.200
Idle engine speed (min ⁻¹)	1.900 – 5.200
Routing depth (mm)	0 – 9
Max. cutter diameter (mm)	118
Dust extraction connection dia. (mm)	27/36
Weight (kg)	5,4



= MMC Multi Material Control electronics

Items included

PF 1200 E-Plus Alucobond GB

V-grooving bit, A4 feeler roller, setting gauge for guide rails, operation tool, without guide rails, in SYSTAINER SYS 4 T-LOC

Order no.

574390

Router tools from page 275





CM 150



06



Chain mortiser: Professional mortising and slotting carpentry machine.

- ▶ Accurate guidance via the precision adjustable parallel fence, with large supporting interface surface
- ▶ Sustainable performance from the heavy-duty motor
- ▶ Versatility of application assured with wide variety of optional mortising and slotting accessories
- ▶ Easy operation due to the ergonomic design and comfortable weight

Technical data

Power consumption (W)	2.000
Mortising depth (mm)	100/150
Side stop setting range (mm)	0 - 150
Drive sprocket speed (min ⁻¹)	4.250
Weight (kg)	8,5

Items included

CM 150/28x40x100 A

chain cutter 28 x 40 x 100 A, side stop, depth stop, 10 m power cord, in carton

Order no.

769534

The multitalented tool for mortising.

With its compact and lightweight design, the CM 150 chain mortiser is particularly easy to handle and thus ideally suited for roof constructions, the renovation and refurbishment of old buildings or aligning the roof truss, and if adjustments or reworking are required on the construction site. With the stable and large side stop, the chain mortiser can be reliably guided, even when working at the installed beam and overhead.

System accessories
from page 276



The Festool system.

Because things work better when everything fits together:

The comprehensive range of system accessories for routers and laminate trimmers leaves nothing to be desired and helps accelerate working processes. From the hole series guide rail, which can also be used with plunge-cut saws and jigsaws, to perfectly adapted cutters and a large selection of copying rings and base runners for a range of applications.



Routing

Accessories and consumable materials

System accessories	266
Routing tools	277



Routing

System accessories



OF 1010

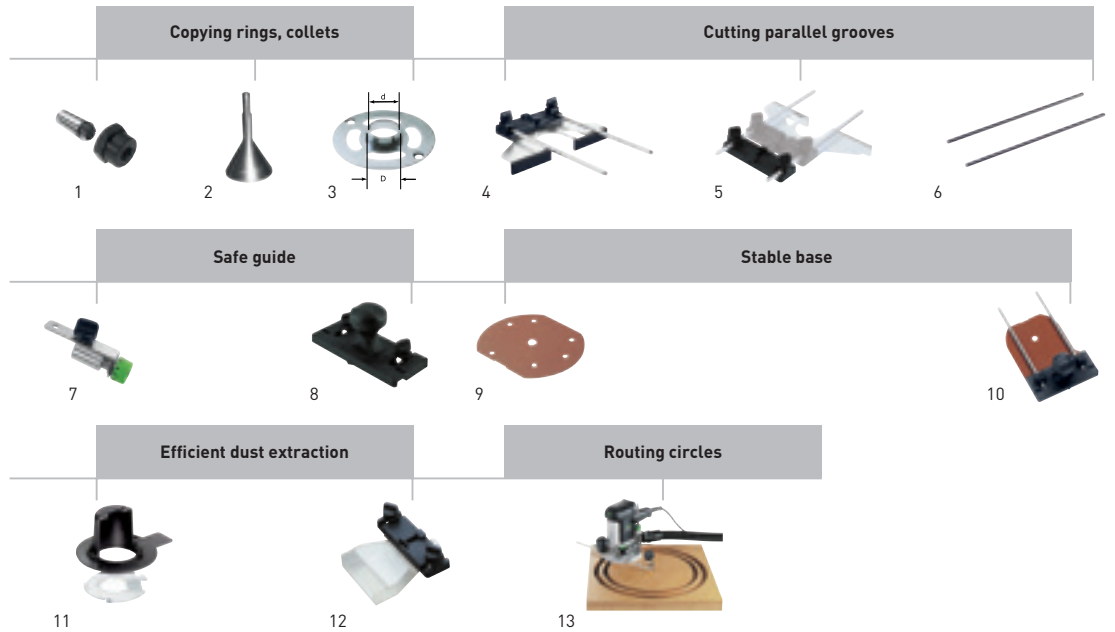

Accessories for router OF 1010

Denomination	Explanation	Order no.
1 Collet SZ-D 6/OF 1000	for MFK/OFK 700, OF 900, OF 1000, OF 1010, KF, with locking nut, for cutter shank \varnothing 6 mm, in self-service display pack	488760
Collet SZ-D 6,35/OF 1000	for MFK/OFK 700, OF 900, OF 1000, OF 1010, KF, with locking nut, for cutter shank \varnothing 6.35 mm (1/4"), in self-service display pack	488761
Collet SZ-D 8/OF 1000	for MFK/OFK 700, OF 900, OF 1000, OF 1010, KF, with locking nut, for router shank \varnothing 8 mm, in self-service display pack	488755
2 Centring mandrel ZD-OF/D 6,35+8	for all Festool routers, for shank support \varnothing 6.35 mm and 8 mm for centering the copying rings, in self-service display pack	492187
3 Copying ring KR D8,5/VS 600-FZ 6	for OF 1010, in bag	490772
Copying ring KR-D 10,8/OF 900	for OF 900, OF 1000, OF 1010, KF, D 10,8 mm, dia. 7,8 mm, in self-service display pack	486029
Copying ring KR-D 13,8/OF 900	for OF 900, OF 1000, OF 1010, KF, D 13,8 mm, dia. 10,8 mm, in self-service display pack	484176
Copying ring KR-D17/OF 900	for OF 900, OF 1000, OF 1010, KF, D 17 mm, dia. 14 mm, in self-service display pack	486030
Copying ring KR D17/VS 600-SZ 14	for OF 1010, in bag	490770
Copying ring KR-D 24/OF 900	for OF 900, OF 1000, OF 1010, KF, D 24 mm, dia. 21 mm, in self-service display pack	486031
Copying ring KR D24/VS 600-SZ 20	for OF 1010, in bag	490771
Copying ring KR-D 27/OF 900	for OF 900, OF 1000, OF 1010, KF, D 27 mm, dia. 24 mm, in self-service display pack	486032
Copying ring KR-D 30/OF 900	for OF 900, OF 1000, OF 1010, KF, D 30 mm, dia. 27 mm, in self-service display pack	486033
Copying ring KR-D 40/OF 900	for OF 900, OF 1000, OF 1010, KF, D 40 mm, dia. 37 mm, in self-service display pack	486034
Adapter D 12/M12 OF2000	for the OF 1400, OF 2000, OF 2200, for cutters with female thread M12x1, in bag	487160
4 Parallel side fence SA-OF 1000	for OF 900, OF 1000, OF 1010, KF, with 2 guide rods, in carton	489427
5 Fine adjuster for parallel side fence FE-OF 1000/KF	for OF 900, OF 1000, OF 1010, KF, for fast and dimensionally accurate adjustment on the parallel side fence, can be retrofitted, delivered without side stop and guide rods, in self-service display pack	483358
6 Guide rods	Included in the OF 1010 delivery	

Accessories for router OF 1010

Denomination	Explanation	Order no.
7 Fine adjuster for guide stop FE-FS/OF 1000	for OF 900, OF 1000, OF 1010, KF, in self-service display pack	488754
8 Guide rail adapter FS-OF 1000	complete with support, for use of routers OF 900, OF 1000, OF 1010 with the FS guidance system, without rods, in self-service display pack	488752
9 Hard fibre base runner TP-OF	for OF 900, OF 1000, OF 1010, KF, centre hole Ø 15 mm, in self-service display pack	489229
10 Extension table TV-OF 1000	for OF 900, OF 1000, OF 1010, KF, to increase the bearing surface when working on edges, delivered without guide rods, in self-service display pack	488756
11 Chip deflector KSF-OF 1010	for OF 900, OF 1000, OF 1010, for sideways extraction, max. aperture 37 mm, in self-service display pack	493180
12 Dust extraction attachment AH-OF 1000	for OF 900, OF 1000, OF 1010, KF, for jointing system VS 500 / VS 600 and for edge trimming, in carton	484453
13 Trammel unit SZ-OF 1000	for OF 900, OF 1000, OF 1010, KF, for cutting radii, circles and decorative curves on surfaces and edges, circle dia. 153 – 760 mm, in self-service display pack	483922

Routing

System accessories



OF 1400

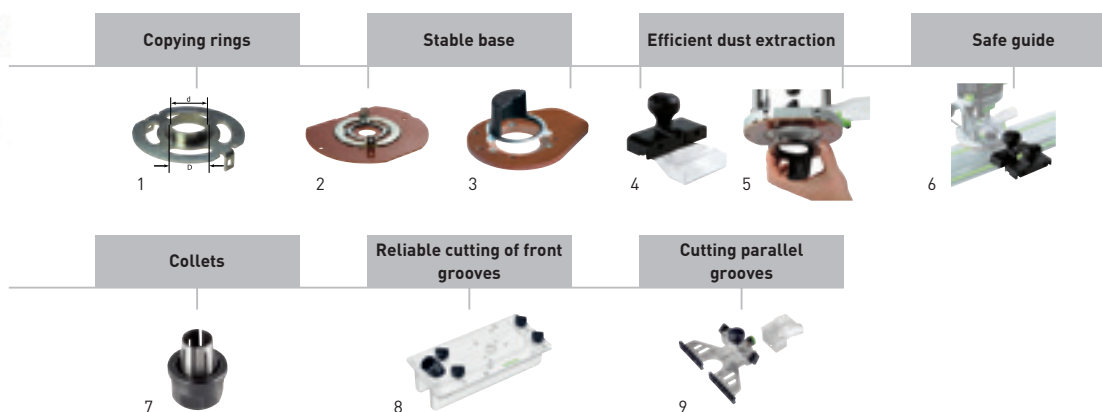

Accessories for router OF 1400

Denomination	Explanation	Order no.
1 Copying ring KR-D 17,0/OF 1400	for OF 1400, D 17 mm, dia. 14 mm, in self-service display pack	493315
Copying ring KR-D 24,0/OF 1400	for OF 1400, D 24 mm, dia. 21 mm, in self-service display pack	492183
Copying ring KR-D 27,0/OF 1400	for OF 1400, D 27 mm, dia. 24 mm, in self-service display pack	492184
Copying ring KR-D 30,0/OF 1400	for OF 1400, D 30 mm, dia. 27 mm, in self-service display pack	492185
Copying ring KR-D 40,0/OF 1400	for OF 1400, D 40 mm, dia. 37 mm, in self-service display pack	492186
Copying ring KR-D 8,5/OF 1400	for OF 1400 / VS 600, D 8,5 mm, dia. 6,5 mm, in self-service display pack	492179
Copying ring KR-D 13,8/OF 1400	for OF 1400 / VS 600, D 13,8 mm, dia. 10,8 mm, in self-service display pack	492180
Copying ring KR-D 17,0/OF 1400	for OF 1400 / VS 600, D 17 mm, dia. 14 mm, in self-service display pack	492181
Copying ring KR-D 24,0/OF 1400	for OF 1400 / VS 600, D 24 mm, dia. 21 mm, in self-service display pack	492182
2 Base runner LA-OF 1400	for OF 1400, hard-fibre base runner with 20 mm centre bore, reduces the opening of the router to the cutter diameter, max. cutter diameter 37 mm, in self-service display pack	492574
3 Running pad with chip deflector LAS-OF 1400	for OF 1400, for sideways extraction, running pad with support extension, max. aperture 63 mm, in carton	493233
4 Dust extraction attachment AH-OF 1400	for OF 1400 / VS 600, for sideways extraction, in carton	492585
5 Chip deflector KSF-OF 1400	for OF 1400, for sideways extraction, in self-service display pack	492732
6 Guide rail adapter FS-OF 1400	for OF 1400, with fine adjustment and support for router without guide rods, without rods, in carton	492601
7 Collet SZ-D 6,0/OF 1400/2000/2200	for the OF 1400, OF 2000, OF 2200, for cutter shank \varnothing 6 mm, in self-service display pack	494459
Collet SZ-D 8,0/OF 1400/2000/2200	for the OF 1400, OF 2000, OF 2200, for router shank \varnothing 8 mm, in self-service display pack	494460
Collet SZ-D 10,0/OF 1400/2000/2200	for the OF 1400, OF 2000, OF 2200, for cutter shank \varnothing 10 mm, in self-service display pack	494461
Collet SZ-D 12,0/OF 1400/2000/2200	for the OF 1400, OF 2000, OF 2200, for cutter shank \varnothing 12 mm, in self-service display pack	494462
Collet SZ-D 6,35/OF 1400/2000/2200	for the OF 1400, OF 2000, OF 2200, for router shaft 6.35 mm, in self-service display pack	494463
Collet SZ-D 9,53/OF 1400/2000/2200	for the OF 1400, OF 2000, OF 2200, for router shaft 9.53 mm, in self-service display pack	494464
Collet SZ-D 12,7/OF 1400/2000/2200	for the OF 1400, OF 2000, OF 2200, for router shaft \varnothing 12.7 mm, in self-service display pack	494465
8 Routing aid OF-FH 2200	for OF 900, OF 1000, OF 1010, OF 1400, OF 2000, OF 2200, safe guidance of the router thanks to the movable legs, in carton	495246
9 Parallel side fence SA-OF 1400	for OF 1400, With fine adjustment and extraction hood, without rods, in carton	492636



OF 2200

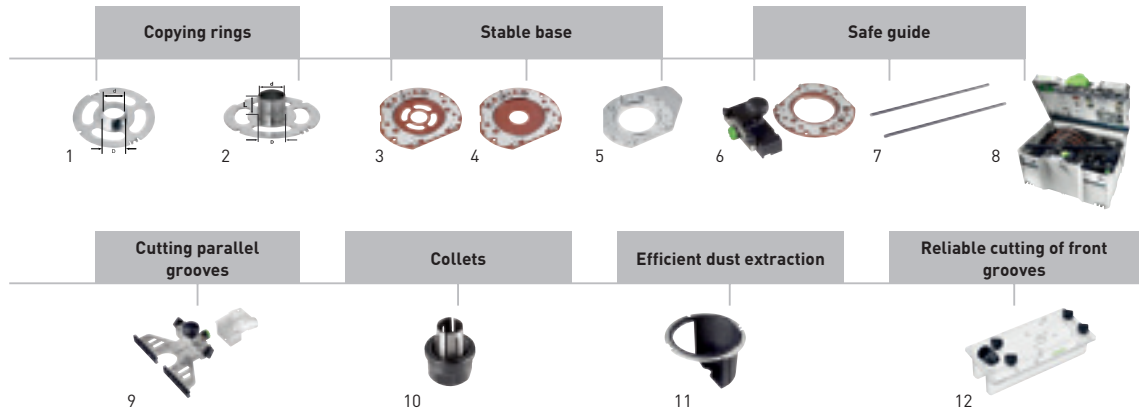

Accessories for the OF 2200 router

Denomination	Explanation	Order no.
1 Copying ring KR-D 12,7/OF 2200	for OF 2200, D 12,7 mm, dia. 10 mm, in self-service display pack	495339
Copying ring KR-D 17,0/OF 2200	for OF 2200, D 17 mm, dia. 15 mm, in self-service display pack	494622
Copying ring KR-D 19,05/OF 2200	for OF 2200, D 19,05 mm, dia. 17 mm, in self-service display pack	495340
Copying ring KR-D 24,0/OF 2200	for OF 2200, D 24 mm, dia. 22 mm, in self-service display pack	494623
Copying ring KR-D 25,4/OF 2200	for OF 2200, D 25,4 mm, dia. 23 mm, in self-service display pack	495341
Copying ring KR-D 27,0/OF 2200	for OF 2200, D 27 mm, dia. 24 mm, in self-service display pack	494624
Copying ring KR-D 30,0/OF 2200	for OF 2200, D 30 mm, dia. 27 mm, in self-service display pack	494625
Copying ring KR-D 34,93/OF 2200	for OF 2200, D 34,93 mm, dia. 32 mm, in self-service display pack	495342
Copying ring KR-D 40,0/OF 2200	for OF 2200, D 40 mm, dia. 37 mm, in self-service display pack	494626
Copying ring KR-D 30,0/21,5/OF 2200	for OF 2200, extra long safety copying ring D30, 21 mm high, required for use of reversible blade cutters 497455 and 497456, D 30 mm, dia. 27 mm, in self-service display pack	497453
2 Adapter KRA-ZOLL/OF 2200	for OF 2200, adapter for imperial copying rings, in self-service display pack	494627
3 Base runner LA-OF 2200 D36 CT	for OF 2200, for copying rings < 30 mm, With openings for optimised extraction, in carton	494675
4 Base runner LA-OF 2200 D36	for OF 2200, reduces the opening of the router to the cutter diameter, in carton	494677
5 Support AFB-OF 2200	for OF 2200, support widener for safe guidance of the router at workpiece edges, in carton	494682
6 Guide rail adapter FS-OF 2200	for OF 2200, Without guide rods ST-OF 2200/2, With fine adjustment and support plate for router, in carton	494681
7 Rod ST-OF 2200/2	for OF 2200, guide rods for side and guide stops 2 pieces, in self-service display pack	495247
8 Accessories set ZS-OF 2200 M	for OF 2200, guide rail adapter, parallel side fence with fine adjustment and extraction hood, Guide rods, copying ring Ø 17 mm, copying ring Ø 24 mm, copying ring Ø 27 mm, copying ring Ø 40 mm, base runner D36, base runner for copying rings, extension, in SYSTAINER SYS 3 T-LOC	497655

Routing

System accessories

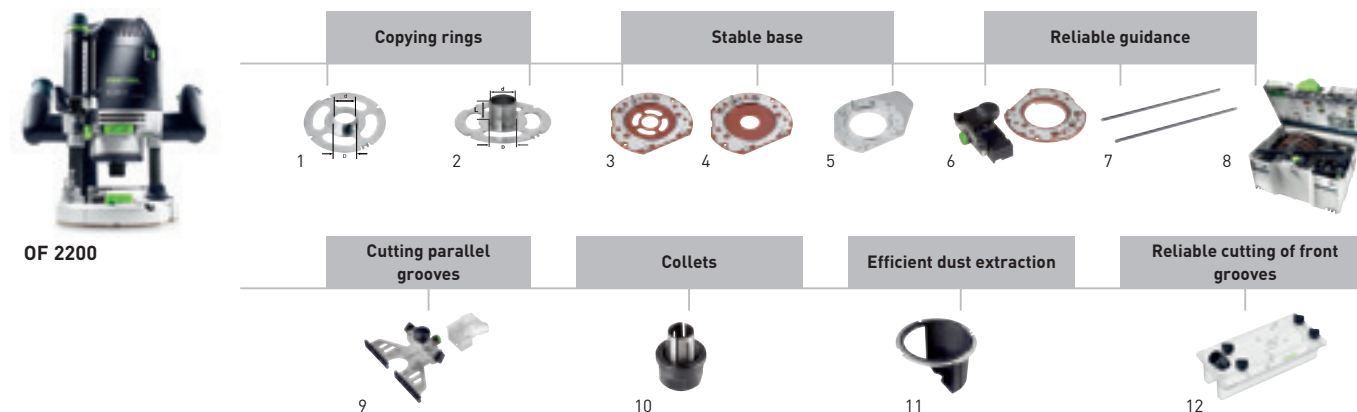

Accessories for the OF 2200 router

Denomination	Explanation	Order no.
9 Parallel side fence SA-OF 2200	for OF 2200, With fine adjustment and extraction hood, Without guide rods ST-OF 2200/2, in carton	494680
10 Collet SZ-D 6,0/OF 1400/2000/2200	for the OF 1400, OF 2000, OF 2200, for cutter shank \varnothing 6 mm, in self-service display pack	494459
Collet SZ-D 8,0/OF 1400/2000/2200	for the OF 1400, OF 2000, OF 2200, for router shank \varnothing 8 mm, in self-service display pack	494460
Collet SZ-D 10,0/OF 1400/2000/2200	for the OF 1400, OF 2000, OF 2200, for cutter shank \varnothing 10 mm, in self-service display pack	494461
Collet SZ-D 12,0/OF 1400/2000/2200	for the OF 1400, OF 2000, OF 2200, for cutter shank \varnothing 12 mm, in self-service display pack	494462
Collet SZ-D 6,35/OF 1400/2000/2200	for the OF 1400, OF 2000, OF 2200, for router shaft 6.35 mm, in self-service display pack	494463
Collet SZ-D 9,53/OF 1400/2000/2200	for the OF 1400, OF 2000, OF 2200, for router shaft 9.53 mm, in self-service display pack	494464
Collet SZ-D 12,7/OF 1400/2000/2200	for the OF 1400, OF 2000, OF 2200, for router shaft \varnothing 12.7 mm, in self-service display pack	494465
11 Chip deflector KSF-OF 2200	for OF 2200, for sideways extraction, max. cutter diameter 80 mm, in self-service display pack	494670
12 Routing aid OF-FH 2200	for OF 900, OF 1000, OF 1010, OF 1400, OF 2000, OF 2200, safe guidance of the router thanks to the movable legs, in carton	495246



OF 1010



OF 1400



OF 2200

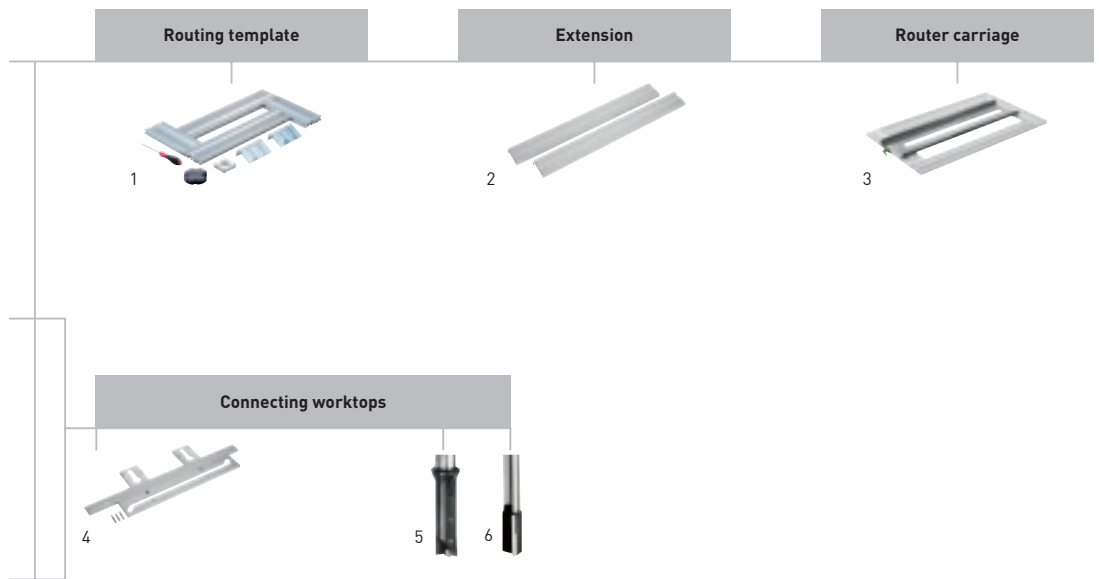

Accessories for multi-routing template MFS

Denomination	Explanation	Order no.
1 Routing template MFS 400	for all routers with copying ring, for rectangular (300 x 100 mm) or curved (Ø 600 mm) cut-outs, 2 x angle stop, tilt protection, circle routing insert, operation tool, dimensions length x width 300 x 100 mm, curves 40 – 600 mm, in carton	492610
Routing template MFS 700	for all routers with copying ring, for rectangular (max. 600 x 300 mm) or curved (max. Ø 1200 mm) cut-outs, 2 x angle stop, tilt protection, circle routing insert, operation tool, dimensions length x width 600 x 300 mm, curves 40 – 1.200 mm, in carton	492611
2 Extension profile MFS-VP 200	for extension of MFS 400, MFS 700, with scale, 2 x profile 200 mm, longitudinal connectors, qty. in pack 2 piece(s), in carton	492722
Extension profile MFS-VP 400	for extension of MFS 400, MFS 700, with scale, 2 x 400 mm profile, longitudinal connectors, qty. in pack 2 piece(s), in carton	492723
Extension profile MFS-VP 700	for extension of MFS 400, MFS 700, with scale, 2 x profile 700 mm, longitudinal connectors, qty. in pack 2 piece(s), in carton	492724
Extension profile MFS-VP 1000	for extension of MFS 400, MFS 700, with scale, 2 x profile 1000 mm, longitudinal connectors, qty. in pack 2 piece(s), in carton	492725
Extension profile MFS-VP 2000	for extension of MFS 400, MFS 700, without scale, 2 x profile 2000 mm, longitudinal connectors, qty. in pack 2 piece(s), in carton	492726
3 Router carriage MFS-FS	for large-surface routing, for MFS 400, MFS 700, traverse path 600 mm, copy ring dia. 30 mm, in carton	495648
4 Worktop template APS 900	for corner and panel connectors with depths of up to 900 mm, for diameter of cutter 14 mm and copying ring 30 mm, corner connection template, profile MFS-VP 1000, 3 x Bolt, operation tool, in carton	492727
5 Reversible blade groove cutter HW shank 12 mm HW S12 D14/45 WM	for OF 1400, OF 2200, D 14 mm, NL 45 mm, GL 105 mm, in self-service display pack	491110
6 Edge trimming cutter HW shank 12 mm HW S12 D14/50	D 14 mm, NL 50 mm, GL 100 mm, in self-service display pack	491089

Routing

System accessories

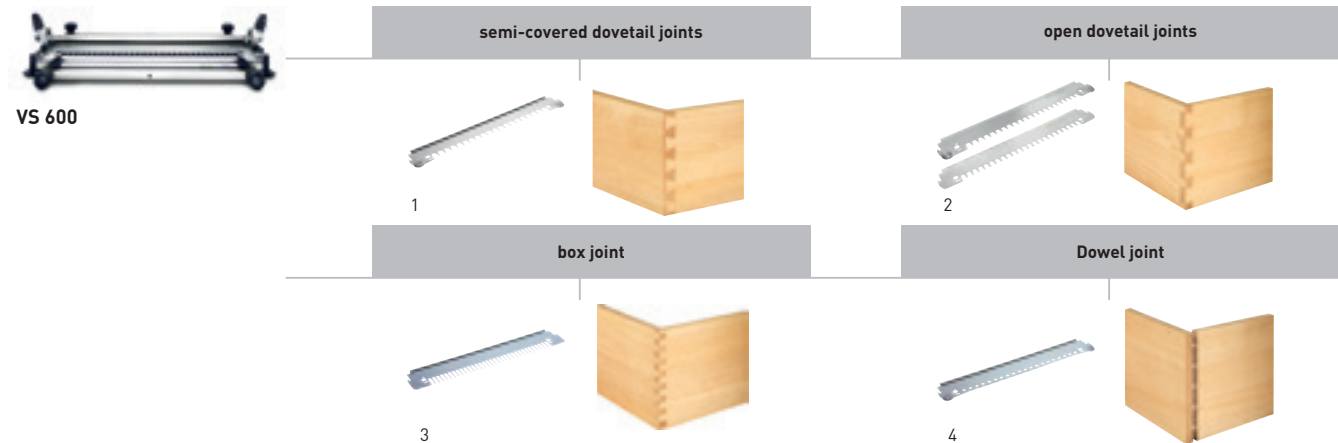

Routing templates and cutters for jointing system VS 600

Denomination	Explanation	Order no.
1 Dovetail joint template VS 600 SZ 14	for OF 1010, OF 1400, for blind dovetail joints, tenon size 14 mm, copying ring \varnothing 17 mm (for OF 1010), workpiece thickness 14 – 20 mm, in carton	488877
Dovetail cutter HS shank 8 mm HS S8 D13,8/13,5/15°	for semi-covered dovetail joints SZ 14, D 13,8 mm, NL 13,5 mm, GL 46 mm, alpha 15°, in self-service display pack	490991
Dovetail cutter HW shank 8 mm HW S8 D13,8/13,5/15°	for semi-covered dovetail joints SZ 14, D 13,8 mm, NL 13,5 mm, GL 46 mm, alpha 15°, in self-service display pack	490992
Dovetail joint template VS 600 SZ 20	for OF 1010, OF 1400, for blind dovetail joints, tenon size 20 mm, copying ring \varnothing 24 mm (for OF 1010), workpiece thickness 21 – 28 mm, in carton	488878
Dovetail cutter HS shank 8 mm HS S8 D20/17/15°	for semi-covered dovetail joints SZ 20, D 20 mm, NL 17 mm, GL 49 mm, alpha 15°, in self-service display pack	490995
Dovetail cutter HW shank 8 mm HW S8 D20/17/15°	for semi-covered dovetail joints SZ 20, D 20 mm, NL 17 mm, GL 49 mm, alpha 15°, in self-service display pack	490996
2 Template-kit VS 600 SZO 14	for OF 1010, OF 1400, open dovetail joint, slot size 14 mm, copying ring \varnothing 8.5 mm (for OF 1010), copying ring \varnothing 17 mm (for OF 1010), workpiece thickness 10 – 14 mm, in carton	491152
Dovetail cutter HW shank 8 mm HW S8 D14,3/16/10°	for open dovetail joints SZO 14, D 14,3 mm, NL 16 mm, GL 50 mm, alpha 10°, in self-service display pack	491164
Template-kit VS 600 SZO 20	for OF 1010, OF 1400, for exposed dovetail joints, tenon size 20 mm, copying ring \varnothing 13.8 mm (for OF 1010), copying ring \varnothing 24 mm (for OF 1010), workpiece thickness 14 – 25 mm, in carton	491153
Dovetail cutter HW shank 8 mm HW S8 D20/26/10°	for open dovetail joint slots, SZO 20, D 20 mm, NL 26 mm, GL 58 mm, alpha 10°, in self-service display pack	491165
Spiral groove cutter HW shank 8 mm HW Spi S8 D10/30	for slot joints FZ 10 and open dovetail joints SZO 20 with fine precision in diameter, D 10 mm, NL 30 mm, GL 60 mm, in self-service display pack	490980
3 Slot joint template VS 600 FZ 6	for OF 1010, OF 1400, for slot joint connections, tenon size 6 mm, copying ring \varnothing 8.5 mm (for OF 1010), workpiece thickness 6 – 10 mm, in carton	488879
Spiral groove cutter HW shank 8 mm HW Spi S8 D6/21	for slot joints FZ 6 and open dovetail joints SZO 14 with fine precision in diameter, D 6 mm, NL 21 mm, GL 50 mm, in self-service display pack	490978
Spiral groove cutter HS shank 8 mm HS Spi S8 D6/16	for slot joints FZ 6 and open dovetail joints SZO 14 with fine precision in diameter, D 6 mm, NL 16 mm, GL 50 mm, in self-service display pack	490944
Slot joint template VS 600 FZ 10	for OF 1010, OF 1400, for slot joint connections, tenon size 10 mm, copying ring \varnothing 13.8 mm (for OF 1010), workpiece thickness 10 – 20 mm, in carton	488880
Spiral groove cutter HS shank 8 mm HS Spi S8 D10/30	for slot joints FZ 10 and open dovetail joints SZO 20 with fine precision in diameter, D 10 mm, NL 30 mm, GL 60 mm, in self-service display pack	490946
4 Jointing system dowel joint unit VS 600 DS 32	for OF 1010, OF 1400, dowelling joint in the 32 grid, copying ring \varnothing 13.8 mm (for OF 1010), in carton	488881
Dowel drill HW shank 8 mm HW S8 D5/30 Z	with brad point, D 5 mm, NL 30 mm, GL 53,5 mm, in self-service display pack	491066
Dowel drill HW shank 8 mm HW S8 D6/30 Z	with brad point, D 6 mm, NL 30 mm, GL 53,5 mm, in self-service display pack	491067
Dowel drill HW shank 8 mm HW S8 D8/30 Z	with brad point, D 8 mm, NL 30 mm, GL 53,5 mm, in self-service display pack	491068
Dowel drill HW shank 8 mm HW S8 D10/30 Z	with brad point, D 10 mm, NL 30 mm, GL 53,5 mm, in self-service display pack	491069



Hole series system



Edge trimming system

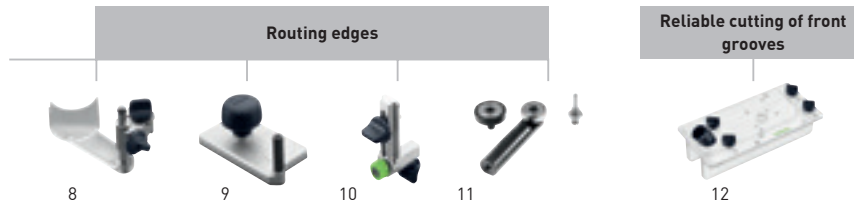

Accessories for hole series system, edge trimming system

Denomination	Explanation	Order no.
1 Guide rail FS 1400/2-LR 32	with row of holes, length 1.400 mm, in carton	496939
Guide rail FS 2424/2-LR 32	with row of holes, length 2.424 mm, in carton	491622
2 Stopper LA-LR 32 FS	positions the first hole on the hole series guide rail at a distance of 9.5, 16 or 32 mm from the workpiece edge, qty. in pack 2 piece(s), in self-service display pack	496938
3 Hole drilling set LR 32 Set	for routers OF 900, OF 1000, OF 1010, OF 1400 in the FS-LR32 hole drilling system, for use with hole line guide rails, guide plate, centring mandrel, 2 x side stop, 2 x Longitudinal stop, in carton	583290
4 Hole drilling set LR 32-SYS	for OF 900, OF 1000, OF 1010, OF 1400, for use with hole line guide rails, guide plate, centring mandrel, operation tool, hinge location cutter HM Ø 35 mm, dowel drill HW Ø 5 mm (V-shaped tip), dowel drill HM Ø 5 mm (with centring bit and pre-cutter), 2 parallel side fences with adjustable stop, clamp FSZ 120, 2 x Longitudinal stop, in SYSTAINER SYS 1 T-LOC	584100
5 Parallel side fence SA-LR 32	with adjustable stop, for parallel alignment of guide rails, in carton	485758
6 Adjustable stop AR-LR 32	for OF 900, OF 1000, OF 1010, OF 1400, for parallel side fence, in carton	485759
7 Guide plate FP-LR 32	for routers OF 900, OF 1000, OF 1010, OF 1400 in the FS-LR32 hole drilling system, centring mandrel, in carton	494340
8 Chip guard SF-OF	for OF 900, OF 1000, OF 1010, KF, in self-service display pack	486242
9 Edging plate UP-OF	for OF 900, OF 1000, OF 1010, KF, angle arm WA-OF and edging plate UP-OF are needed for the flush trimming of projected edges, in self-service display pack	486058
10 Angle arm WA-OF	for OF 900, OF 1000, OF 1010, OF 1400, KF, needed to copy workpieces in conjunction with the copier scanning set KT-OF, in self-service display pack	486052
11 Copier scanning set KT-OF	for OF 900, OF 1000, OF 1010, OF 1400, KF, copier scanning set KT-OF and angle arm WA-OF are needed to copy workpieces, in self-service display pack	486534
12 Routing aid OF-FH 2200	for OF 900, OF 1000, OF 1010, OF 1400, OF 2000, OF 2200, safe guidance of the router thanks to the movable legs, in carton	495246

Routing

System accessories



OFK 500



OFK 700

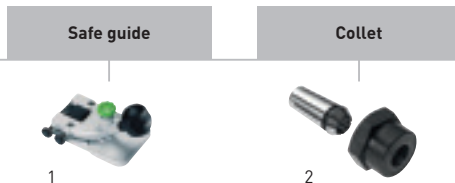

MFK 700

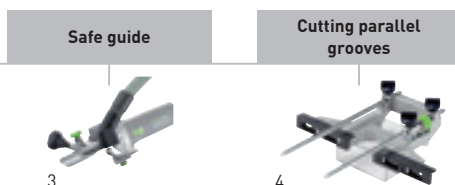

Accessories for laminate trimmer OFK 500, OFK 700, module edge router MFK 700

Denomination	Explanation	Order no.
1 Router table FT 0°	for routing accurate angles, in carton	491427
2 Collet SZ-D 6/OF 1000	for MFK/OFK 700, OF 900, OF 1000, OF 1010, KF, with locking nut, for cutter shank Ø 6 mm, in self-service display pack	488760
Collet SZ-D 6,35/OF 1000	for MFK/OFK 700, OF 900, OF 1000, OF 1010, KF, with locking nut, for cutter shank Ø 6.35 mm (1/4"), in self-service display pack	488761
Collet SZ-D 8/OF 1000	for MFK/OFK 700, OF 900, OF 1000, OF 1010, KF, with locking nut, for router shank Ø 8 mm, in self-service display pack	488755
3 Router table FT-MFK 700 1,5° Set	for MFK/OFK 700, tarnishing pad, extraction hood, in carton	495165
4 Parallel side fence SA-MFK 700	for MFK 700, with fine adjuster, extraction hood, 2 x Guide rods, in carton	495182



PF 1200

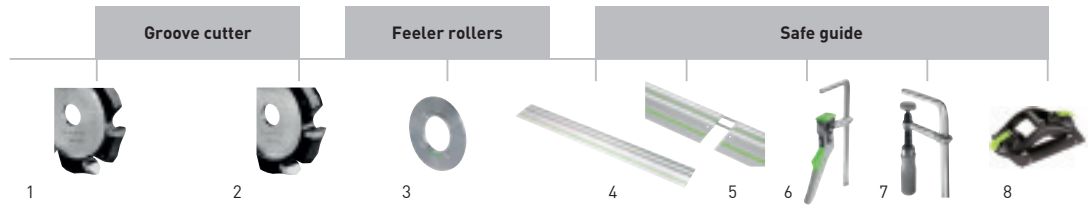

OF 1010

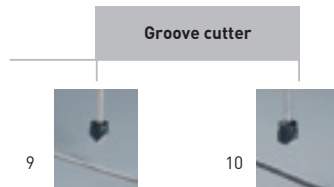

Accessories for PF 1200 aluminium composite milling machine, OF 1010 router

Denomination	Explanation	Order no.
1 V-groove cutter HW 118x14-90°/Alu	D 118 mm, alpha 90°, in self-service display pack	491470
2 V-groove cutter HW 118x18-135°/Alu	D 118 mm, alpha 135°, in self-service display pack	491471
3 Feeler roller for aluminium composite panels D2	disc size 2 mm, in self-service display pack	491542
Feeler roller for aluminium composite panels D3	disc size 3 mm, in self-service display pack	491543
Feeler roller for aluminium composite panels D4	disc size 4 mm, in self-service display pack	491544
Feeler roller for aluminium composite panels D6	disc size 6 mm, in self-service display pack	491545
Feeler roller for aluminium composite panels A3	disc size 3 mm, in self-service display pack	491538
Feeler roller for aluminium composite panels A4	disc size 4 mm, in self-service display pack	491539
Feeler roller for aluminium composite panels A6	disc size 6 mm, in self-service display pack	491540
4 Guide-rails	from page 400	
5 Connecting piece FSV	to connect guide rails for long workpieces, qty. in pack 1 piece(s), in self-service display pack	482107
6 Lever clamp FS-HZ 160	for FS/2, MFT, solid steel version, clamping width 160 mm, in self-service display pack	491594
7 Fastening clamp FSZ 120	for FS/2, MFT, solid steel version, clamping width 120 mm, qty. in pack 2 piece(s), in self-service display pack	489570
Fastening clamp FSZ 300	for FS/2, MFT, solid steel version, clamping width 300 mm, qty. in pack 2 piece(s), in self-service display pack	489571
8 dual suction pad GECKO DOSH	from page 401	
9 V-groove cutter HW shank 8 mm HW S8 D18-90° (Alu)	D 18 mm, NL 8 mm, GL 59 mm, alpha 90°, in self-service display pack	491444
10 V-groove cutter HW shank 8 mm HW S8 D18-135° (Alu)	D 18 mm, NL 3,3 mm, GL 59 mm, alpha 135°, in self-service display pack	491443

Routing

System accessories



CM 150



Accessories for chain mortiser CM 150

Denomination	Explanation	Order no.
1 Guide frame GM 145	for chain cutters 100-150 mm in length, for mortising, pneumatic springs, depth stop, side stop, mort. depth for chain cutter 100: 95 mm, mort. depth with chain cutter 125: 120 mm, mort. depth with chain cutter 150: 145 mm, side stop setting range 5 - 150 mm, weight 4,8 kg, in carton	769541
2 Chain cutter MF-CM 28x35x100 A	for CM 150, CMP 150, slot width or chain width 28 mm, slot length 35 mm, slot depth 100 mm, in carton	769547
Chain cutter MF-CM 28x40x100 A	for CM 150, CMP 150, slot width or chain width 28 mm, slot length 40 mm, slot depth 100 mm, in carton	769548
Cutting chain MC-CM 28x35/40x100 A	for chain cutter MF-CM 28 x 35/40 x 100 A, MF-CMP 28 x 35/40 x 100 A, Individual milling machine chain for fittings, slot length 35 mm, slot depth 100 mm, in carton	769551
Chain cutter MF-CM 28x40x150 A	for CM 150, CMP 150, slot width or chain width 28 mm, slot length 40 mm, slot depth 150 mm, in carton	769549
Cutting chain MC-CM 28x40x150 A	for chain cutter MF-CM 28 x 40 x 150 A, MF-CMP 28 x 40 x 150 A, Individual milling machine chain for fittings, slot length 40 mm, slot depth 150 mm, in carton	769552
Chain cutter MF-CM 30x30x125 B	for CM 150, CMP 150, slot width or chain width 28 mm, slot length 30 mm, slot depth 125 mm, in carton	769550
Cutting chain MC-CM 30x30x125 B	for chain cutter MF-CM 30 x 30 x 125 B, MF-CMP 30 x 30 x 125 B, Individual milling machine chain for fittings, slot length 30 mm, slot depth 125 mm, in carton	769553

If you want to achieve guaranteed quality, compromise is out of the question. Festool therefore recommends that you always use original Festool routing accessories for all Festool routers. Manufactured with the same care as the machines themselves from high grade steel and extremely wear-resistant carbide, the tools include cutting blades that boast exceptional micro-grain quality and density. Outstanding cutter geometry means the tools are synonymous with superior durability and superb results.

The right material for every application

HW Tungsten carbide

HW routers are ideally suited to processing hardwood, panel materials and plastic.

HS High performance, high speed steel

This steel has mechanical and thermal properties that are best suited for routing soft materials such as spruce and pine.

Tip

For the best routing patterns, the cutters should always be mounted at the lowest depth possible, and at least as far as the marking for minimum clamping length on the router shank.

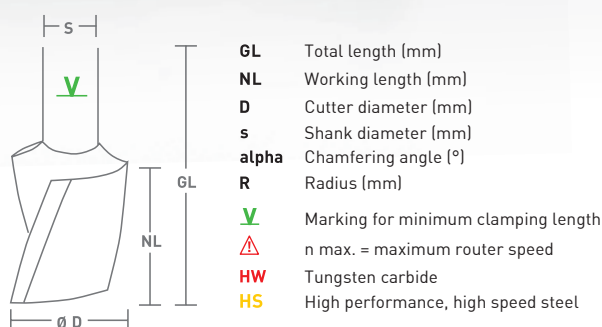

Expertise in routing – Festool cutters.

Festool cutters allow you to tackle a wide range of applications safely and optimally. Machines, cutters and useful accessories – expertise from a single source.

Disk groove cutter

from page 294



Dowel drill

from page 295

Hinge location cutter

from page 294

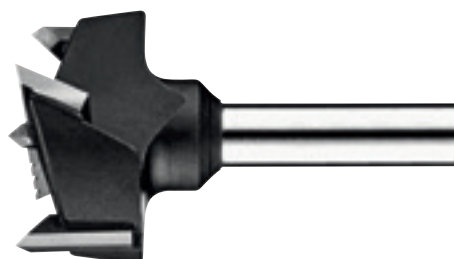

Spiral groove cutter

from page 282



Groove cutter

from page 280



Reversible blade rebating cutter
from page 283

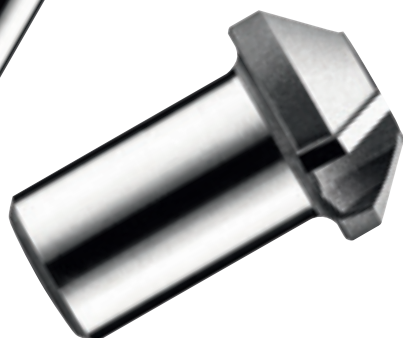

OFK 500 cutter
from page 302

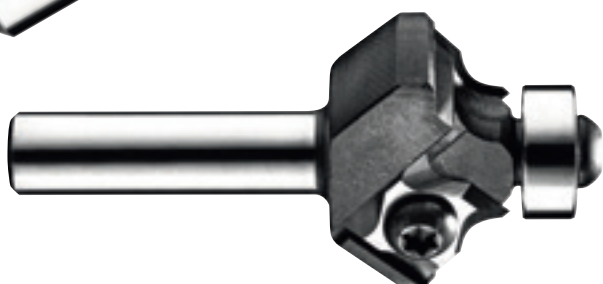

Reversible-blade classic ogee cutter
from page 301



Rebating head and cutter spindle
from page 294

Specialised cutters for solid surface and mineral materials
from page 304

Routing

Routing tools

Groove cutter

HW
s = 8

Router cutter HW, solid hard metal with base blade, shank 8 mm



D	NL	GL	Order no.
3	6	45	490952
4	10	45	490953
5	12	45	490954
6	14	55	490955
7	17	55	490956
8	20	55	490957
8	30	60	491647

No compromises.

The partially ground standard tungsten carbide blade provides an increased service life when drilling panel materials

HW
s = 8

Router cutter HW with fitted base blade, shank 8 mm



* for slot jointing with the Festool VS 600, with extra precision in the diameter

D	NL	GL	Order no.
9	23	55	490958
10	20	60	490959
10	25	60	490960 *
10	30	60	491648
11	20	60	490961
12	20	60	490962
12	30	60	491649
13	20	60	490963
14	20	60	490964
15	20	60	490965
16	20	60	490966
16	30	65	490967
18	20	60	490968
18	30	65	490969
19	20	60	490970
20	20	60	490971
20	30	65	490972
22	20	60	490973
24	20	60	490974
25	20	60	490975
30	20	60	490976

Long service life, even when plunge cutting.

If you wish to achieve quality cutting results with ease when drilling, grooving, rebating and long-hole routing, you are best advised to use the HW groove cutter. It cuts precisely, makes drilling easier and has a long service life.

Hard-wearing drill point.

After drilling 60 holes in a kitchen worktop (30 mm deep): Cutting edge only shows slight signs of wear.



Ground drill point.

After drilling 60 holes in a kitchen worktop (30 mm deep): Blunt cutting edge.



Groove cutter

HW
s = 12

Router cutter HW with fitted base blade, shank 12 mm



D	NL	GL		Order no.
10	35	90		491086
12	40	90	③	491087
13,2	35	85	①	493789
14	40	85		491088
14	50	100		491089
15	35	85	②	493790
16	45	90		491090
16	60	100		491091
18	45	90		491092
20	45	90	④	491093
22	45	90		491094
24	45	90		491095
30	35	90		491096

HW "Schall-Ex" and "Planet" groove cutter.

The perfect solution when installing automatic door seals on-site.

Effective dimensions of seal types

Gasket	Width (mm)	Depth	Cutter type
Planet HS	13,1	30	①
Schall-Ex L	14,8	32	②
Schall-Ex RD	14,8	28	②
Draft excluders	12,0	40	③
Double seals	12,0	40	③
Schall-Ex Ultra	19,7	30	④

HS
s = 8

Router cutter HS single-edged, with base blade, Shank 8 mm

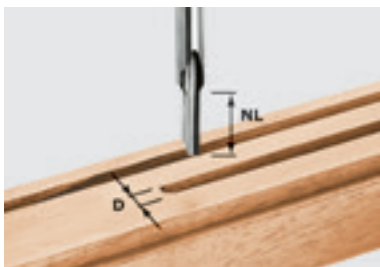

D	NL	GL	Order no.
3	8	45	490941
4	15	48	490942
5	12	50	490943

Routing

Routing tools

Cutter box, spiral groove cutter

Router bit box



Order no.

Items included with the router bit box

Edge trimming cutter HW D12.7/NL25 KL, **498979**
 dowel drill HW D5 x 30 Z,
 groove cutter HW D10/20 with drill point,
 groove cutter HW D18/30 with drill point,
 classic ogee cutter HW D16.7/R2 KL,
 classic ogee cutter HW D25.5 R6.3 KL,
 classic ogee cutter HW D31.7 R9.5 KL,
 chamfer cutter HW D36/45° KL,
 groove cutting disc HW D40 x 4,
 cutter spindle for disk groove cutter KL 16,
 dovetail cutter HW D13.8/15°

Cutter set for the professional.

The cutter box contains 11 cutters for the most important and most frequent applications. This therefore offers a price saving compared with purchasing each of them individually. The individual cutters are clearly and safely stored in a transparent cutter magazine in the cutter set.

HS
s = 8

Spiral router cutter HS with base blade, Shank 8 mm

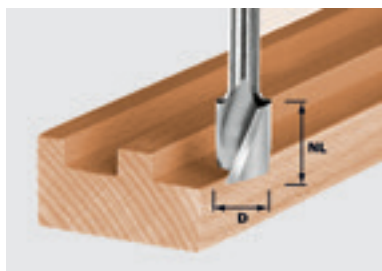

* for slot jointing with the Festool VS 600, with extra precision in the diameter

D	NL	GL	Order no.
6	16	50	490944 *
8	19	50	490945
10	30	60	490946 *
12	20	52	490947
14	20	52	490948
16	20	52	490949
18	25	57	490950
20	25	57	490951

Multi-talented.

The HS spiral groove cutter and the HW solid carbide spiral groove cutter: Fast rate of advance for grooving, rebating, long-hole cutting, drilling and copy routing. The chips are drawn upwards by the spiral cutter, keeping the groove permanently clean.



Spiral groove cutter, reversible blade rebating cutter

HW
s = 8

Spiral router cutter HW solid hard metal with base blade, Shank 8 mm

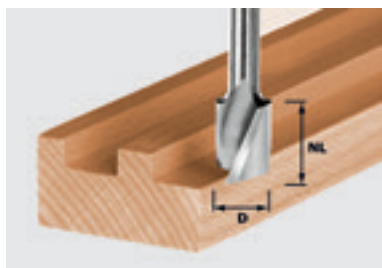

D	NL	GL	Order no.
4	10	45	490977
6	21	50	490978
8	25	55	490979
10	30	60	490980

HW
s = 8

Turning plate router cutter HW single-edged, with base blade, Shank 8 mm



D	NL	GL	Order no.
8	20	50	491078
10	25	55	491079
12	30	61	491080
14	30	66	492715
16	30	70	492716
18	30	70	492717

Accessories for turning plate router cutter HW, single-edged with base blade, Shank 8 mm

Replacement blade for cutter HW-WP 20x4,1x1,1 (4x) for cutter 491078	491386
Replacement blade for cutter HW-WP 25x5,5x1,1 (4x) for cutter 491079 (4 pcs)	491387
Replacement blade for cutter HW-WP 30x5,5x1,1 (4x) for cutters 491080, 492715	491388
Reversible blade HW-WP 30x12x1,5 (4x) for 492716, 492717, 491120 cutters, main plate	491393
Replacement blade for cutter HW-WP 7,6x12x1,5 (4x) pre-cutter for 492716, 492717, 491120 cutters	491390

Its efficiency speaks for itself.

The reversible blades provide consistent cutter dimensions and precision – without resharping. Quick cutter changes and reversible blade guarantee sharp cutters and greater economic efficiency at all times.



HW
s = 12

Turning plate router cutter HW single-edged, with base blade, shank 12 mm

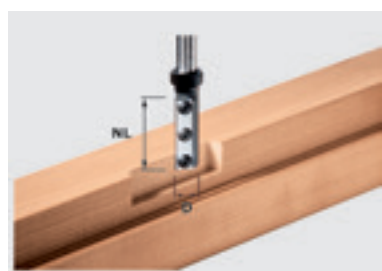

D	NL	GL	Order no.
16	50	110	497454

Accessories for reversible blade rebating cutter HM, single edge with plunge point, shank 12 mm

Reversible blades Wepla Set D 16 2+2 spare reversible blades set for cutter 497454	497458
---	---------------

Routing

Routing tools

Reversible blade rebating cutter

HW
KN

Turning plate router cutter HW single-edged, with base blade, direct bit holder

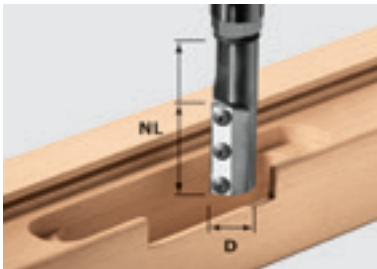

D	NL	GL	Order no.
20	50	110	497455
24	50	117	497456

Accessories for turning plate router cutter HW, single-edged with base blade, direct bit holder

Reversible blade Wepla Set D 20 2+2 **497568**
 spare reversible blade set for cutter 497455

Reversible blade Wepla Set D 24 2+2 **497569**
 spare reversible blades set for cutter 497456

Copying ring **497453**
KR-D 30,0/21,5/OF 2200
 for OF 2200, extra long safety copying ring D30, 21 mm high, required for use of reversible blade cutters 497455 and 497456, D 30 mm, Dia. 27 mm

For door hinges in block frames and door leaves.

The extra long reversible blade cutter is suitable for extreme routing depths, with direct bit holder for 20 and 24 mm diameters. For precision working in combination with router OF 2200 and extra long copying ring (order no. 497453).



Step cutter, ovolo edge cutter, half-round cutter

HW s = 12 Stepped cutter, Shank 12 mm



D1	D2	NL	T1	Order no.
16,3	12,3	14	9,3	492713
20,3	12,3	14	6	492714

Perfect when combined with the routing aid.

The stepped cutter and the Festool routing aid can be used to rout windows and house doors quickly and precisely, making sure they do not tilt or wobble.

HW s = 8 Ovolo edge cutter HW, shank 8 mm

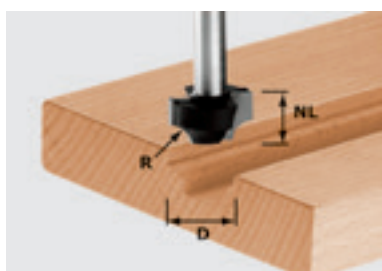

D	NL	GL	R	Order no.
17	10	40	3	491004
23	13	45	6	491007

For decorative front design of inlays

It is possible to plunge-cut centrally into the front of the furniture using the standard bit.

HW s = 8 Half-round cutter HW with ball bearing guide, shank 8 mm

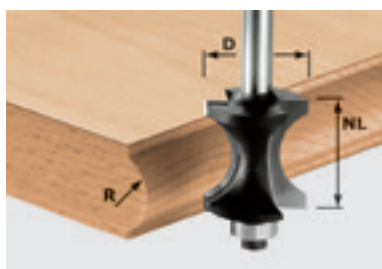

D	NL	GL	R	Order no.
27	28	70	12	491139

Accessories for half-round cutter HW

Ball bearing guide D12,7 (2x) Qty. in pack 2 piece(s), Diameter 12,7 mm	491383
---	---------------

For the complete job.

For decorative board edging the HW halfround cutter does a great job. It is perfectly designed for 28 mm thick laminated wood board. Its ball bearing guide guides the router directly along the template and ensures that curved parts can also be profiled.

Routing

Routing tools

Roundover cutter, roundover/chamfer cutter

HW
s = 8

Ogee cutter HW with ball bearing guide, shank 8 mm



* delivered items include Ø 12.7 mm and Ø 9.5 mm ball bearing

D	NL	GL	R	Order no.
16,7	9	49	2	491009
19,1	10	50	3	491010 *
20,7	11	51	4	491011 *
22,7	12	52	5	491012 *
25,5	13,5	54	6,35	491013 *
28,7	15	55	8	491014 *
31,7	16,5	56	9,5	491015 *
38,1	19	59	12,7	491016 *
42,7	22	62	15	491017 *

Accessories for classic ogee cutter HW

Ball bearing guide D12,7 (2x) Qty. in pack 2 piece(s), Diameter 12,7 mm	491383
Ball bearing guide D 9,53 (2x) Diameter 9,53 mm, Qty. in pack 2 piece(s)	491382

One tool – two uses.



With ball bearing guide Ø 12.7 mm for rounding



With ball bearing guide Ø 9.5 mm for beading

HW
s = 12

Ogee cutter HW with ball bearing guide, shank 12 mm



D	NL	GL	R	Order no.
63	32	82	25	491107

Accessories for classic ogee cutter HW

Ball bearing guide D12,7 (2x) Qty. in pack 2 piece(s), Diameter 12,7 mm	491383
Ball bearing guide D 9,53 (2x) Diameter 9,53 mm, Qty. in pack 2 piece(s)	491382

HW
s = 8

Ogee chamfer cutter HW with ball bearing guide, Shank 8 mm



D	NL	GL	R	Alpha	Order no.
17,5	19	61	6	15	491134
23,1	19	60	6	30	491135
31,4	18,5	60	6	45	491136

Accessories for classic ogee/chamfer cutter HW, Shank 8 mm

Ball bearing guide D17,5/15° (2x) for cutter 491134, Alpha 15°, D 17,5 mm, Qty. in pack 2 piece(s)	491403
Ball bearing guide D23,1/30° (2x) for cutter 491135, D 23,1 mm, Alpha 30°, Qty. in pack 2 piece(s)	491404
Ball bearing guide D31,4/45° (2x) for cutter 491136, D 31,4 mm, Alpha 45°, Qty. in pack 2 piece(s)	491405



Reversible bladed for chamfer/edge-trimming cutter, chamfer cutter

HW
s = 8

Turning plate chamfer/edge-trimming cutter HW with ball bearing guide, Shank 8 mm

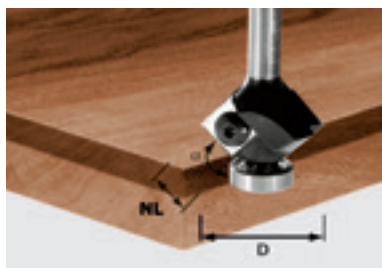

D	NL	GL	Alpha	Order no.
27	8	55	45	499807

Accessories for turning plate slot cutter HW

Ball bearing guide D12,7 (2x) Diameter 12,7 mm, Qty. in pack 2 piece(s)	491383
Reversible blade HW-WP 12x12x1,5 (4x)	491391

Precisely calculated.

The edge trimming cutter with HW reversible blades is the ideal tool for those who attach great importance to a long service life, outstanding economic efficiency and constant precision. Purchase one reversible blade, receive the service life of four cutters and save on consequential costs because the cutter can be reversed.

HW
s = 8

Chamfer cutter HW with ball bearing guide, Shank 8 mm



D	NL	GL	Alpha	Order no.
18	11	50	15	499801
25,7	25,1	70	15	491132
25	11	50	30	499800
38,5	25,7	64	30	491133
26	7	48	45	499799
36	11,5	53	45	491025

Accessories for chamfer cutter HW

Ball bearing guide D12,7 (2x) Qty. in pack 2 piece(s), Diameter 12,7 mm	491383
---	---------------

An unbeatable team.

You can also produce this familiar edge shape commonly found in industry using these shank cutters in a portable router. Here the chamfer cutter and classic ogee cutter with conical ball bearing guide work together perfectly.



HW
s = 12

Chamfer cutter HW, Shank 12 mm



D	NL	GL	Alpha	Order no.
44	30	80	30	491101
55	20	76	45	491102

Accessories for chamfer cutter HW

Ball bearing guide D12,7 (2x) Qty. in pack 2 piece(s), Diameter 12,7 mm	491383
---	---------------

Routing

Routing tools

Round nose cutter, flute cutter

HW
s = 8 **Water gutter cutter HW with ball bearing guide, Shank 8 mm**

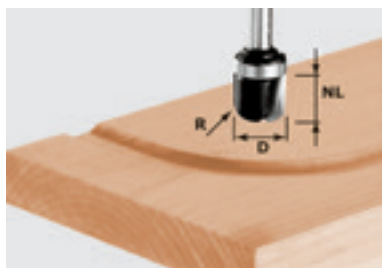

D	NL	GL	R	Order no.
19	16	53	6,4	490982

Accessories for round nose cutter HW

Ball bearing guide D19 (2x) Qty. in pack 2 piece(s), Diameter 19 mm	491396
---	---------------

Routing without a copying ring.

This cutter can produce curved or round water channels 1:1 without any problem using a template. Time-consuming calculation of curves and distances is no longer necessary.

HW
s = 8 **Water gutter cutter HW, Shank 8 mm**



D	NL	GL	R	Order no.
16	25	65	5	490981



HW
s = 8 **Flute cutter HW, Shank 8 mm**

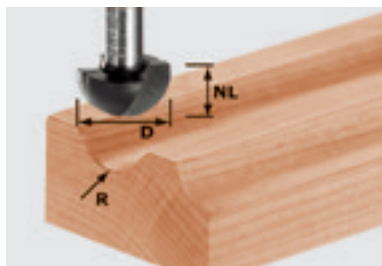

D	NL	GL	R	Order no.
8	8	38	4	490983
12,7	10	40	6,35	490984
16	11	41	8	490985
19,4	11	41	9,7	490986
25,4	14	44	12,7	490987

HW
s = 12 **Flute cutter HW, shank 12 mm**

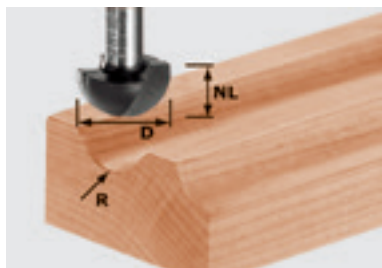

D	NL	GL	R	Order no.
30	20	60	15	491104
40	25	65	20	491105

HW
s = 8 **Flute cutter HW with ball bearing guide, shank 8 mm**



D	NL	GL	R	Order no.
25,5	12,7	54	6,35	491018
28,7	14	56	8	491019
31,7	14,3	56	9,5	491020
38,1	16	57	12,7	491021

Accessories for flute cutter HW

Ball bearing guide D12,7 (2x) Diameter 12,7 mm, Qty. in pack 2 piece(s)	491383
---	---------------

Flush trim cutter, turning plate edge trimming cutter

HW s=8 Edge trimming cutter HW with ball bearing guide, shank 8 mm

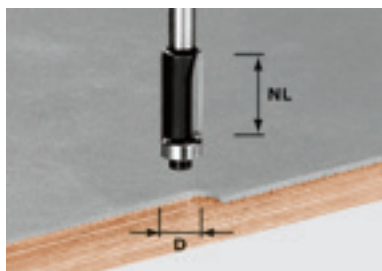

D	NL	GL	Alpha	Order no.
12,7	25	65	0	491027

Accessories for edge trimming cutter HW

Ball bearing guide D12,7 (2x)	491383
Qty. in pack 2 piece(s), Diameter 12,7 mm	

Through thick and thin.

The HW template router is the ideal tool for simple 1:1 copy routing thanks to its large ball bearing guide.

HW s=8 Edge trimming cutter HW with ball bearing guide, shank 8 mm

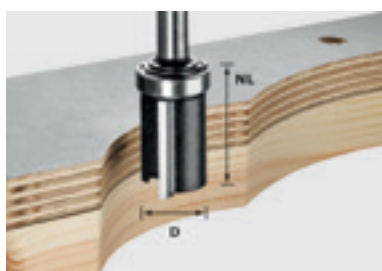

D	NL	GL	Alpha	Order no.
19,05	25	62	0	491028

Accessories for edge trimming cutter HW

Ball bearing guide D19 (2x)	491396
Diameter 19 mm, Qty. in pack 2 piece(s)	



HW s=8 Turning plate edge trimming cutter HW with ball bearing guide, shank 8 mm

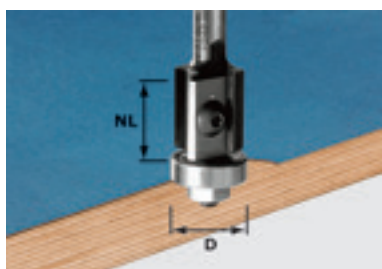

D	NL	GL	Alpha	Order no.
19	20	64	0	491082

19	12	52	0	499806
----	----	----	---	--------

Accessories for turning plate slot cutter HW

Ball bearing guide D19 (2x)	491385
Diameter 19 mm	
Reversible blade for cutter HW-WP 20x12x1,5 (4x)	491392
Reversible blade HW-WP 12x12x1,5 (4x)	491391

Precision – even after sharpening.

When sharpening blunt edges on conventional cutters, the diameter aligned to the ball bearing guide normally decreases. This causes a ridge to form when edges are trimmed flush after the bit is sharpened. The turning plate slot cutter and ball bearing guide maintain a high level of precision.

Routing

Routing tools

Edge trimming chamfer cutter, drilling cutter, rebating cutter

HW s=8 Chamfer/edge trimming cutter with ball bearing guide, shank 8 mm

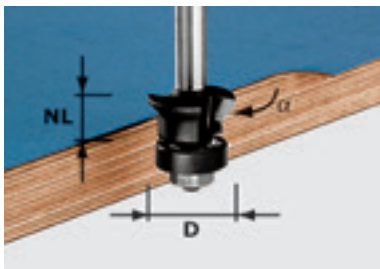

D	NL	GL	Order no.
24	11	54	491026

Accessories for edge trimming chamfer cutter

Ball bearing guide D18 (2x) Diameter 18 mm	491400
--	--------

One tool – three uses.

Flush trimming of protruding coatings at a right angle, with a 45° chamfer or even both in one working process. The plastic-coated ball bearing guide does not leave any marks and protects the edge of the workpiece.



Flush chamfered flush + chamfered

HW s=8 Drilling cutter HW, shank 8 mm



D	NL	GL	Order no.
8	19	65	491037

Plunge – cut – finished.

The drilling cutter plunges directly into the laminate without requiring pre-drilling and trims the prepared contour flush when guided along the side face.

HW s=8 Turning plate rebating cutter with ball bearing guide, shank 8 mm



D	NL	GL	Order no.
38	12	53,7	491085 *

Accessories for turning plate rebating cutter

Reversible blade HW-WP 12x12x1,5 (4x)	491391
Ball bearing guide D9,5/12,7/16/19/22 Diameter 9,5; 12,7; 16; 19; 22 mm	491406

* Items included: ball bearing set, Ø 9.5 mm to Ø 22 mm

Amazingly versatile.

Change ball bearings to rout to 5 different rebate depths with only one basic bit.

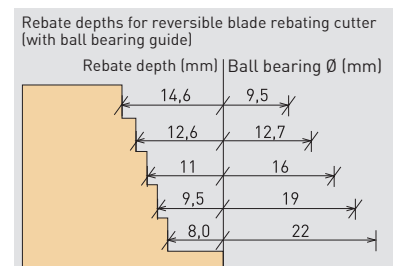

HW s=8 Rebating cutter HW with ball bearing guide, shank 8 mm



D	NL	GL	Order no.
31,7	12,7	54	491022 **

Accessories for rebating cutter HW

Ball bearing guide D12,7 (2x) Qty. in pack 2 piece(s), Diameter 12,7 mm	491383
Ball bearing guide D9,5/12,7/16/19/22 Diameter 9,5; 12,7; 16; 19; 22 mm	491406

** Items included: 1 ball bearing Ø 12.7 mm with 9.5 mm rebate depth

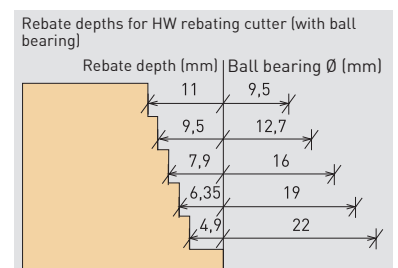

Dovetail cutter, hand grip/hand rail cutter

HW
s = 8

Dovetail cutter with pre-cutter, shank 8 mm



D	NL	GL	Alpha	Order no.
14,3	13,5	46	15	490990

Perfect for dovetail joints.

It is possible to produce traditional open and hidden dovetail joints in no time at all using the appropriate router, template and router tool system.

HW
s = 8

Dovetail cutters, shank 8 mm



D	NL	GL	Alpha	Order no.
13,8	13,5	46	15	490992 *
16	13,5	46	15	490993 *
20	17	49	15	490996 *
14,3	16	50	10	491164 **
20	26	58	10	491165 **



06

HS
s = 8

Dovetail cutters, shank 8 mm



D	NL	GL	Alpha	Order no.
13,8	13,5	46	15	490991 *
20	17	49	15	490995 *



For use with jointing system VS 600:
* for partially covered dovetail joint
** for open dovetail joint

HW
s = 8

Recessed grip cutter HW with ball bearing guide, shank 8 mm



D	NL	GL	R	Order no.
19	19	68	16	491033

Accessories for hand hole cutter HW

Ball bearing guide D19 (2x)	491396
Diameter 19 mm, Qty. in pack 2 piece(s)	

HW
s = 8

Hand rail cutter HW, shank 8 mm

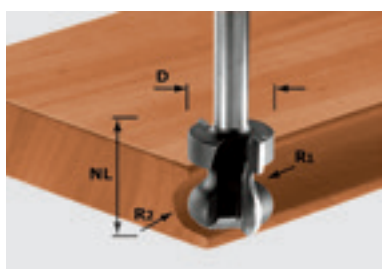

D	NL	GL	R	Order no.
22	16	59	2,5/6	491140



Routing

Routing tools

Tongue and groove cutter, script cutter

HW s=8 Tongue and groove cutter HW, shank 8 mm



D	NL	GL	Order no.
34	32	62	491034

Setting table for tongue and groove cutters

Wood thickness (1)	Height, Y dimension (2)	Stop, X dimension (3)
12	9,2	8,8
13	9,7	9,3
14	10,2	9,8
15	10,7	10,3
16	11,2	10,8
17	11,7	11,3
18	12,2	11,8
19	12,7	12,3
20	13,2	12,8
21	13,7	13,3

As both workpieces that are to be glued are to be processed in one cutter setting, the setting of the mitre tongue and groove cutter requires the precise adjustment of the stop and the table height. The graphic above and the settings table can be used for assistance. Nevertheless, readjustment may be necessary.

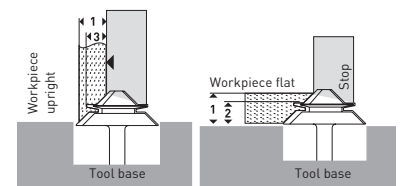

HW s=12 Mitre tongue and groove cutter, shank 12 mm

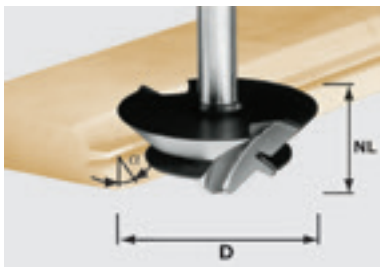

D	NL	GL	Alpha	Order no.
64	27	67	45	492709

⚠ n max. 22,000

HW s=8 Script cutter, shank 8 mm

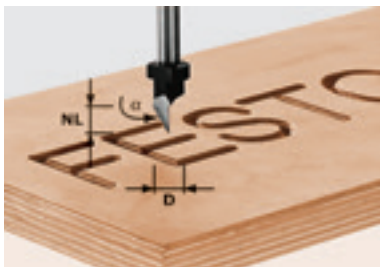

D	NL	GL	Alpha	Order no.
11	9,5	55	60	491003

HS s=8 Script cutter, shank 8 mm

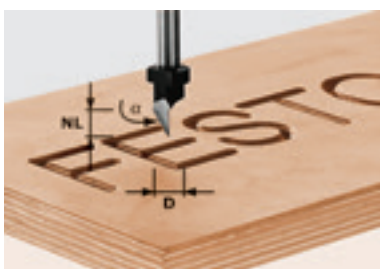

D	NL	GL	Alpha	Order no.
11	9,5	55	60	491002

V-groove cutter, plasterboard V-groove cutter

HW
s = 8 V-groove cutter, shank 8 mm

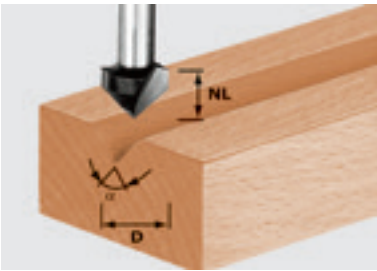

D	NL	GL	Alpha	Order no.
14	7	50	90	490999

Ideal for decorative veining.

The V-groove cutter is the right choice for decorative veining on workpieces with flush joints – e.g. door frames, furniture frame joints and furniture components.

HS
s = 8 V-groove cutter, shank 8 mm

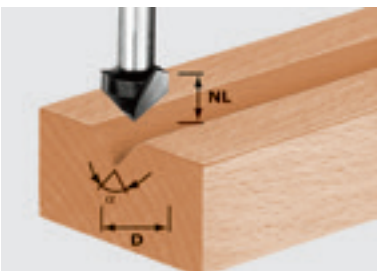

D	NL	GL	Alpha	Order no.
14	7	50	90	490998

11	9,5	50	60	490997
----	-----	----	----	---------------

HW
s = 8 V-groove cutter, for processing aluminium composite panels, shank 8 mm



D	NL	GL	Alpha	Order no.
18	3,3	59	135	491443

18	8	59	90	491444
----	---	----	----	---------------

Routing aluminium composite panels

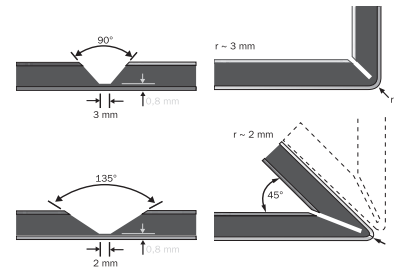

HW
s = 8 Cutter V groove HW, shank 8 mm



D	NL	GL	Alpha	Order no.
12,5	14	55	45	491000 *

32	16	49	90	491001
----	----	----	----	---------------

Routing and jointing instead of gluing and smoothing.

A 45° cutter for rebating 45° corner joints is now available in addition to the 90° plasterboard V-groove cutter.

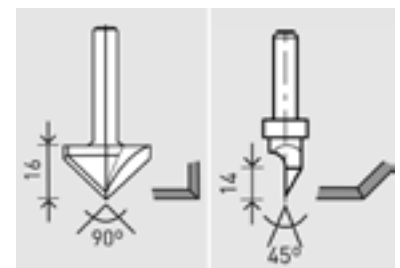

90° plasterboard V-groove cutter (Order no. 491001)

45° plasterboard V-groove cutter (Order no. 491000)

* single-edged tool

Routing

Routing tools

Disk groove cutter, hinge location cutter

HW
s = 8

Groove cutting disc HW

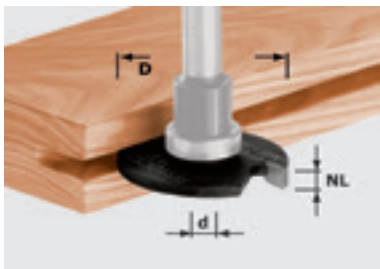

D	Dia.	NL	Order no.
40	6	1,5	491038
40	6	2	491040
40	6	2,5	491056
40	6	3	491057
40	6	3,5	491058
40	6	4	491059
40	6	5	491060

3 different cutter spindles are available for use of the disc groove cutter from 1.5 mm to 5 mm groove width.

Cutter spindle 1 has a fixed shaft, which is not suitable as a thrust surface (fire hazard). Therefore, this cutter spindle is only intended for work with a side stop. Cutter spindle 2 is equipped with a 16 mm ball bearing (above the disc slot), which serves as a thrust surface. With this cutter spindle, a groove depth of 12 mm results from the use of the 40 mm disc slot. Cutter spindle 3 is equipped with a 28 mm ball bearing (above the disc slot), which serves as a thrust surface. With this cutter spindle, a groove depth of 6 mm results from the use of the 40 mm disc slot.

HW
s = 8

Cutter spindle for groove cutting disc HW

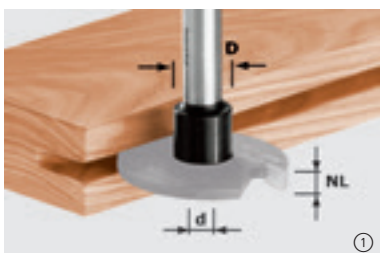

D	Dia.	GL	BB	Order no.
14	6	49	-	499805
16	6	43	16	499803
28	6	45	28	499804

For sealed doors.

A cutter spindle with ball bearing guide D 28 and disc groove cutter with a width of 4 mm are ideal for routing door seals in door frames.



Accessories for cutter spindle, shank 8 mm

Ball bearing guide D16 (2x) Diameter 16 mm	②	491384
Ball bearing guide D28 (2x) Diameter 28 mm		491397

HW
s = 8

HW hinge location cutter with HW chip breaker, shank 8 mm



D	GL	Order no.
15	54,5	491070
18	54,5	491071
20	54,5	491072
25	54,5	491073
26	54,5	491074
30	54,5	491075
34	54,5	491076
35	54,5	491077

Accurate dimensioning with System 32.

The LR 32 hole series system makes routing a row of holes for shelves and false floors amazingly simple. The holes for hinge fittings are also cut accurately between the holes on the System 32 grid.

Dowel/through-hole drill, T-slot cutter, roman ogee cutter, multi profile cutter

HW
s = 8 **Dowel drill HW, shank 8 mm**

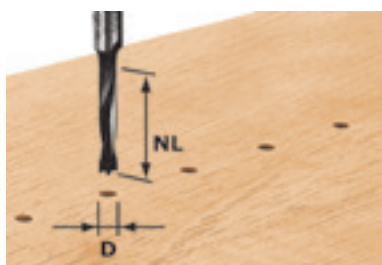

* without centre point

D	NL	GL	Order no.
3	16	55	491065 *
5	30	53,5	491066
6	30	53,5	491067
8	30	53,5	491068
10	30	53,5	491069

Versatile use.

The dowel drill HW is ideal for drilling rows of holes and combining with the dowel unit from jointing system VS 600.



HW
s = 8 **Drill HW, shank 8 mm**



D	NL	GL	Order no.
5	30	53,5	491064

HW
s = 8 **Roman ogee cutter HW with ball bearing guide, shank 8 mm**



D	NL	GL	R1	R2	Order no.
31,7	13	53	4	4	491029
38,1	19	59	6,35	6,35	491030

Accessories for double radius cutter

Ball bearing guide D12,7 (2x) 491383
Diameter 12,7 mm, Qty. in pack 2 piece(s)

HW
s = 8 **Multi-profile cutter HW with ball bearing guide, shank 8 mm**



D	NL	GL	R	Order no.
36,7	21	61	6	491031

Accessories for multi-profile cutter

Ball bearing guide D12,7 (2x) 491383
Diameter 12,7 mm, Qty. in pack 2 piece(s)

HW
s = 8 **Key-hole cutter HW, shank 8 mm**

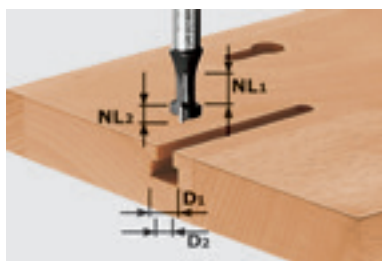

D1	D2	NL1	NL2	GL	Order no.
10,5	6	8	5	50	491035

Excellent for special tasks.

For cutting T-grooves, shaped holes and keyhole mountings in solid wood and panel material.

Routing

Routing tools

Profile cutter, counterprofile cutter

HW
s = 8 **Profile cutter HW, shank 8 mm**

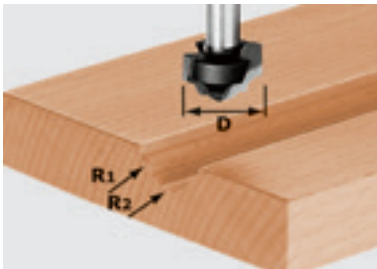

D	NL	GL	R1	R2	Order no.
19	12,5	54	4	5	491032



HW
s = 8 **Profile cutter HW, shank 8 mm**



D	NL	GL	R1	R2	Order no.
42	13	50	6	12	491137



HW
s = 8 **Profile cutter radius HW with ball bearing guide, shank 8 mm**



D	NL	GL	R	Order no.
42	14	54	6	491131

Accessories for profile cutters, radius

Ball bearing guide D12,7 (2x) Diameter 12,7 mm, Qty. in pack 2 piece(s)	491383
--	--------

Simple and exact.

This profile cutter with its long-drawn radius is the ideal power tool for rounding furniture fronts, tabletops, benches or chairs. Curved or round parts can also be rounded easily with this tool.

HW
s = 8 **Counterprofile cutter spring HW with ball bearing guide, shank 8 mm**



D	NL	B	R	Order no.
43	21	5	16	491130

Accessories for counterprofile cutter, tongue

Ball bearing guide D16 (2x) Diameter 16 mm	491384
--	--------

Framed doors with counterprofile and panelling.

Whether you wish to produce traditional profiles or modern shapes – adjusting the cutting rings is simple with the ball bearing guide.

HW
s = 8 **Counterprofile cutter groove HW with ball bearing guide, shank 8 mm**



D	NL	B	R	Order no.
43	21	5	16	491129

Accessories for counterprofile cutter groove HW

Ball bearing guide D16 (2x) Diameter 16 mm	491384
--	--------

Profile tongue cutter, profile groove cutter, facing cutter

HW
s = 8 **Profile/spring cutter HW with ball bearing guide, shank 8 mm**



D	NL	B	R	Order no.
46	20	4	22	490643

For classic furniture fronts.

You can cut classic framed doors in differing styles using these tool sets. The double-edged carbide tools achieve a clean, even routing pattern.

HW
s = 8 **Profile/groove cutter HW with ball bearing guide, shank 8 mm**



D	NL	B	R	Order no.
46	20	4	22	490645



HW
s = 12 **Plane cutter HW with ball bearing guide, shank 12 mm**



D	NL	GL	R	Order no.
67	12	68	19	490127

 n max. 22,000



Facing cutter with ball bearing: for cutting classic curved panelling.

Routing

Routing tools

Facing cutter

HW s = 8 Facing cutter HW, shank 8 mm





D	NL	GL	R	Order no.
42,7	13	50	6	491138

Facing and counterprofiling all in one.
You can use this tool to cut the panelling and the frame and produce complete fronts in combination with a disc groove cutter.

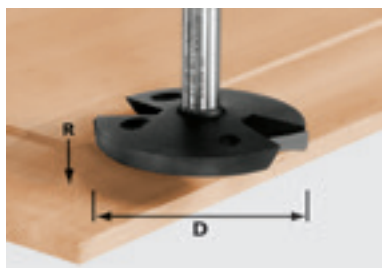

HW s = 12 Facing cutter HW, shank 12 mm



D	NL	GL	R	Order no.
 68	14	58	35	492712

 n max. 22,000



Facing cutter without ball bearing:
for deeper tapers.

Handrail cutters, aluminium cutters

HW hand rail cutter, shank 12 mm

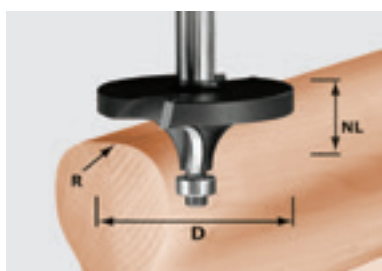

D	NL	R	Order no.
△ 64	26	16	492710

Accessories for HW hand rail cutter

Ball bearing guide D12,7 (2x) Diameter 12,7 mm, Qty. in pack 2 piece(s)	491383
--	--------

△ n max. 22,000

Bench-mounted router TF 2200.

The CMS with OF 2200 router is ideal for cutting workpieces with larger diameters and always provides a secure support surface during routing.

HW Hand rail cutter HW Profile, shank 12 mm

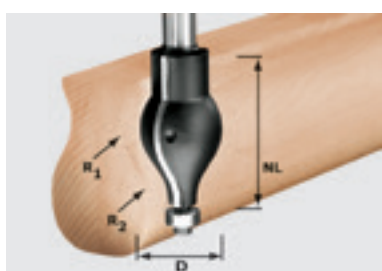

D	NL	R1	R2	Order no.
△ 32	57	20	16	492711

Accessories for HW hand rail cutter

Ball bearing guide D12,7 (2x) Qty. in pack 2 piece(s), Diameter 12,7 mm	491383
--	--------

△ n max. 22,000



06

HS Aluminium cutter HS, shank 8 mm



D	NL	GL	Order no.
5	23	65	491036

The aluminium specialist.

The HS aluminium cutter is designed for routing water drainage channels in aluminium profiles up to 2 mm thick.

Routing

Routing tools

Cutter tools for OFK 700 and MFK 700

HW
s=8

Edge trimming cutter HW, Shank 8 mm



D	NL	GL	Order no.
19	15	46	491666



You can find a comprehensive selection of slot cutters specially designed for routing and cutting slots for edging on page 294. The cutter spindle is required for this application.

HW
s=8

Turning plate edge trimming cutter HW, Shank 8 mm

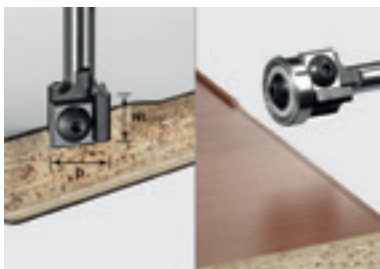

D	NL	GL	Alpha	Order no.
19	12	52	0	499806

Accessories for turning plate edge trimming cutter

Reversible blade HW-WP 12x12x1,5 (4x)	491391
Ball bearing guide D19 (2x) Diameter 19 mm	491385

Can be used with or without ball bearing.

The recently developed ball bearing attachment system allows you to use trimming cutters with or without a ball bearing guide. Any tool with a ball bearing or external guide system (on the OFK 700, for example) is compatible.

HW
s=8

Turning plate chamfer cutter HW, Shank 8 mm



D	NL	GL	Alpha	Order no.
27	8	55	45	499807

Accessories for turning plate chamfer cutter HW

Ball bearing guide D12,7 (2x) Diameter 12,7 mm, Qty. in pack 2 piece(s)	491383
Reversible blade HW-WP 12x12x1,5 (4x)	491391



HW
s=8

Chamfer cutter HW, Shank 8 mm



D	NL	GL	Alpha	Order no.
18	11	50	15	499801
25	11	50	30	499800
26	7	48	45	499799

Accessories for chamfer cutter HW

Ball bearing guide D12,7 (2x) Qty. in pack 2 piece(s), Diameter 12,7 mm	491383
--	--------



Cutter tools for OFK 700 and MFK 700

HW s=8 Classic ogee cutter HW, Shank 8 mm



D	NL	GL	R	Qty. in pack	Order no.
20	2,2	47	2	1	499798
22	3,2	48	3	1	499797

Accessories for HW classic ogee cutter

Ball bearing guide D12,7 (2x) Diameter 12,7 mm, Qty. in pack 2 piece(s)	491383
---	--------



Router table 0° for straight routing.
Order no. 491427.

HW s=8 Classic ogee cutter HW with reversible blades



D	NL	R	GL	Order no.
28	3	1	55	499811
28	3	1,5	55	499810
28	3	2	55	499809
28	3	3	55	499808

Accessories for classic ogee cutter HW with reversible blades

Replacement cutters HW-WP R3 D28 KL12,70FK for Wepla roundover cutters 499808, qty. in pack: 2, reversible blades can be used 4 times, R 3 mm	500369
Replacement cutters HW-WP R2 D28 KL12,70FK for Wepla roundover cutters 499809, qty. in pack: 2, reversible blades can be used 4 times, R 2 mm	500370
Replacement cutters HW-WP R1,5 D28 KL12,70FK for Wepla roundover cutters 499810, qty. in pack: 2, reversible blades can be used 4 times, R 1,5 mm	500371
Replacement cutters HW-WP R1 D28 KL12,70FK for Wepla roundover cutters 499811, qty. in pack: 2, reversible blades can be used 4 times, R 1 mm	500372
Ball bearing guide D12,7 (2x) Diameter 12,7 mm, Qty. in pack 2 piece(s)	491383

Ideal for routing edging: The MFK 700 Basic edge router with spring-loaded ball bearing guide brake and chip deflector, designed specially for machining the most delicate of edging without leaving behind marks.



HW s=8 HW plane cutter for MFK 700 EQ/B-Plus module edge router, Shank 8 mm



D	NL	Alpha	GL	Order no.
28	7	15	40	500368



Routing

Routing tools

Cutter tools for OFK 500 and putty router KF 5

HW
OFK 500

Roundover cutter, without ball bearing guide

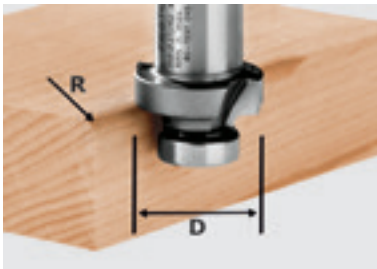

D	R	Order no.
27	2	490092
27	3	490093
27	4	490094
27	5	490095
27	6	490096

Accessories for cutters OFK 500

Ball bearing guide KLS-D 15,8-OFK for cutter 490090, 490091, 490092, 490093, 490094, 490095, 490096, 491533, with clamping screw	490249
--	---------------



Rounding plastic or solid wood veneer.

HW
OFK 500

Chamfer cutter, without ball bearing guide



D	Alpha	Order no.
27	60	491533
27	45	490090
27	30	490091

Accessories for cutters OFK 500

Ball bearing guide KLS-D 15,8-OFK for cutter 490090, 490091, 490092, 490093, 490094, 490095, 490096, 491533, with clamping screw	490249
--	---------------



Chamfering plastic or solid wood veneer.

HW
OFK 500

Edge trimming cutter, with ball bearing guide

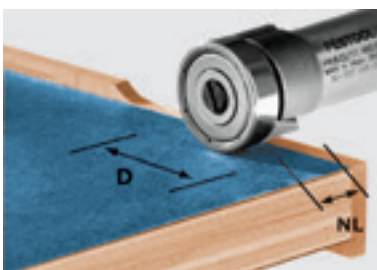

D	NL	Order no.
22	8	490565
22	8	490085 *

Accessories for cutters OFK 500

Ball bearing guide KLS-D22-OFK for cutter 490085, with clamping screw	490250
--	---------------



Flush trimming of plastic or solid wood veneer.

* Flush trim cutter without ball bearing

Cutters for putty routers

HW
s = 8

Rebate clearing cutter HW, shank 8 mm



D	NL	GL	Order no.
33	15	68	483249

For windows after removal of glazing.

This carbide cutter is ideal for routing windows after the glazing is removed. Available with ball bearing for flush trimming or rebating to different depths.

Rebate clearing cutter HW, with fixed top ball bearing



D	NL	GL	Order no.
30	21	68	482057

Accessories for putty routers

Bearing guide KF-05 8/17 Rebate width 8 mm, Ball bearing guide dia. 17 mm	480175
Bearing guide KF-03 9/15 Rebate width 9 mm, Ball bearing guide dia. 15 mm	480173
Bearing guide KF-04 10/13 Rebate width 10 mm, Ball bearing guide dia. 13 mm	480174
Bearing guide KF-07 11/11 Rebate width 11 mm, Ball bearing guide dia. 11 mm	480177
Bearing guide KF-06 12/9 Ball bearing guide dia. 9 mm, Rebate width 12 mm	480176
Rebating cutter KF-S3 replacement cutter for 482057	434690



Routing

Routing tools

Specialised cutters for solid surface and mineral materials

HW s = 12 Reversible blade groove cutter HW, Shank 12 mm

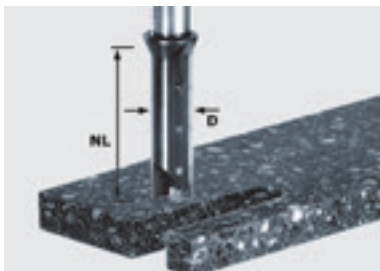

D	NL	GL	Order no.
14	45	105	491110 *

Accessories for turning plate groove cutter

Reversible blade HM-WP 50x5,5x1,1 (4x)	491389
---	--------

Extremely resistant to breaking and very efficient.

Solid carbide spiral groove cutters are manufactured from cylindrical rods of carbide specially developed for machining mineral materials and particularly resistant to breaking.

* also suitable for use with OF 2200 and worktop template APS 900

HW s = 12 Spiral groove cutter, TC, Shank 12 mm

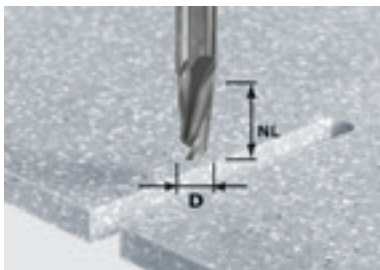

D	NL	GL	Order no.
12	27	70	492654
12	42	87	492655



HW s = 12 Spiral groove cutter with roughing and finishing, TC, Shank 12 mm

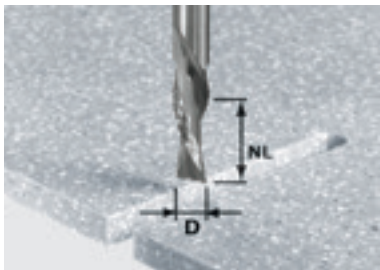

D	NL	GL	Order no.
12	42	87	492656

For fast working progress.

Solid carbide cutters specially designed for routing cut-outs for basins, for example.



HW s = 12 Turning plate edge trimming cutter HW with ball bearing guide, Shank 12 mm

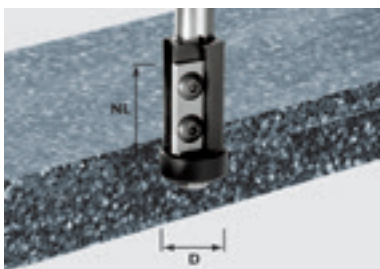

D	NL	GL	Order no.
21	30	89	491120

Accessories for turning plate edge trimming cutter

Reversible blade HW-WP 30x12x1,5 (4x) for 492716, 492717, 491120 cutters, main plate	491393
Ball bearing guide D21-15,88 (2x) Diameter 21 mm	491408

Precise and durable.

Mineral materials are very demanding on the cutting blade. When working with the ball bearing guide, it is absolutely vital that the cutter and ball bearing guide are permanently aligned. This is why tools with reversible blades pay dividends within a very short time.

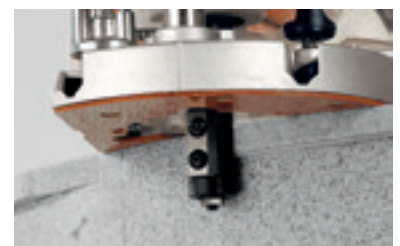

Specialised cutters for solid surface and mineral materials

HW s = 12 **Chamfer cutter HW with ball bearing guide, Shank 12 mm**

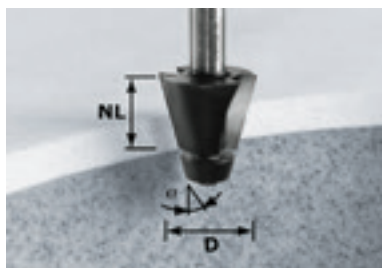

D	NL	Alpha	Order no.
33,54	25	15	492665

Accessories for chamfer cutter with ball bearing guide

Ball bearing guide D18,5/15° Diameter 18,5 mm	493057
---	---------------

HW s = 12 **Reservoir cutter HW with ball bearing guide, Shank 12 mm**

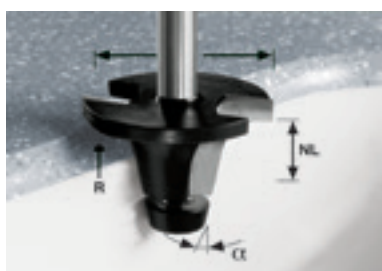

D	NL	R	Alpha	Order no.
45	25	6,35	6	492671

Accessories for basin cutter with ball bearing guide

Ball bearing guide D21,1/6° for router 6°, Diameter 21,1 mm	493061
---	---------------

Ball bearing guide D12,7 Diameter 12,7 mm, Alpha 6°	491398
---	---------------

Simply ingenious.

If the cutting blade is not aligned with the ball bearing guide exactly after sharpening, the joint to the cutter blade can be readjusted by moving the axial ball bearing guide, extending the service life of your Festool basin cutters even longer.



Adjustable axial ball bearing guide on the basin cutter

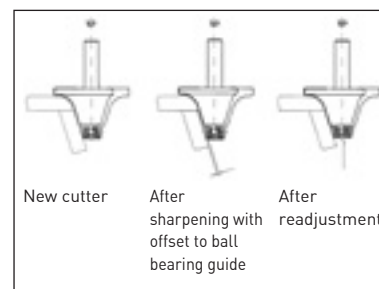

New cutter After sharpening with offset to ball bearing guide After readjustment

Routing

Routing tools

Specialised cutters for solid surface and mineral materials

HW s = 12 **Ogee cutter HW with ball bearing guide, Shank 12 mm**

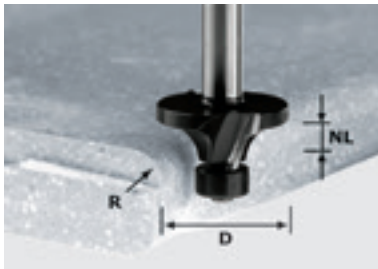

D	NL	R	Order no.
22	10	3	492681

Accessories for HW classic ogee cutter

Ball bearing guide D16 Diameter 16 mm	493062
Ball bearing guide D12,7 (2x) Diameter 12,7 mm, Qty. in pack 2 piece(s)	491383
Ball bearing guide D 9,53 (2x) Diameter 9,53 mm, Qty. in pack 2 piece(s)	491382

A full range.

Roundover cutters with radius of 3 mm to 25.4 mm – with this range, you can meet virtually any demand your customers may have.



Accessories for HW classic ogee cutter, undercut



Diameter	Order no.
28	493063

HW s = 12 **Carbide-tipped facing cutter, Shank 12 mm**

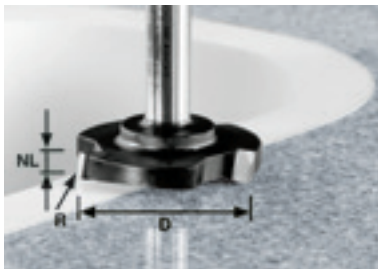

D	NL	R	Order no.
52	7,3	1,5	492701

To suit any task.

Flat protruding edges, e.g. pilaster strip inserts, can be trimmed flush without any problem using the plane cutter.

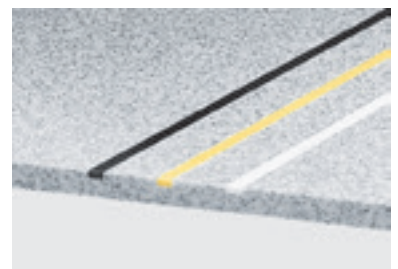

Specialised cutters for solid surface and mineral materials

HW
s = 12 **Edge trimming cutter with ball bearing, top, Shank 12 mm**

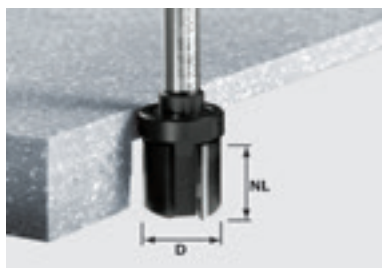

D	NL	Order no.
28	25	492705

Accessories for edge trimming cutter with roller bearing at the top

Ball bearing guide D28 Diameter 28 mm	493063
---	--------

HW
s = 12 **Edge trimming cutter with ball bearing, bottom, Shank 12 mm**

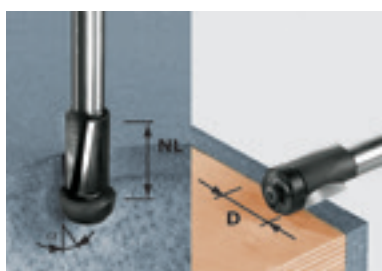

D	NL	Order no.
19	25	492661

Accessories for edge trimming cutter with ball bearing, bottom

Ball bearing guide D19 Diameter 19 mm	493055
Ball bearing guide D22/11° Diameter 22 mm	493056

Both replacement ball bearing guides are included in delivery

Two tools in one.

Cutting inlays flush or routing overhangs on fitted basins at an angle of 11°. Both are possible simply by changing the ball bearing guide included in the delivery.





Planing

Overview of products and applications	310
Electric planers	
One handed planer EHL 65 EQ	312
Planer HL 850	313
Hand-held planer	
Hand-held planer PL 205, PL 245	315
Accessories and consumable materials	316
The Festool system	

Planing

Overview of products and applications

Whether lightweight and handy for assembly tasks or with the maximum rebate depth for an unlimited range of applications – Festool planers have one thing in common: Excellent results.

Page 312 ————— 313 ————— 315 ————— 315

EHL 65 EQ

HL 850

PL 205

PL 245



Applications

Electric planers

Hand-held planer

rebating

Door and window rebates up to 23 mm

Unlimited rebate depth

Strip material, edges, beams, planks, flat surfaces

Trimming work (strip material, edges, board material)

Planing beams, planks and broad surfaces

Proximate planing

Texturing wooden surfaces

Precise results

Drawing cut for clean surfaces

Trimming and planing precise angles

Operation and handling

One-handed operation

Suitable for stationary operation

Dust extraction connector on either side

Planing wide tenons

Planing up to 205 mm

Planing up to 245 mm

Extremely appropriate Appropriate

Technical data

Power consumption (W)	720	850	2.000	2.300
Rotational speed (rpm)	15.600	11.000	13.500	13.000
Planing width (mm)	65	82	205	245
Planing depth (mm)	0 – 4	0 – 3,5	0 – 3	0 – 3
Max. rebate depth (mm)	23	∞		
Connection Ø d/e (mm)	27	36		
Weight (kg)	2,4	3,9	13,0	15,7

The principle of the one-handed planer is exemplary.

Carpenters still regard the classic hand planer as the machine to use for demanding surfaces. With a drawing cut and perfect adjustment of the blade angle, we have



adopted and transferred this principle to the unique spiral blade.



Noticeably more refined, considerably quieter.

The spiral blade is diagonal instead of horizontal and makes a drawing cut that reduces machine noise considerably and produces a much more refined planing pattern. No chatter marks. No reworking.



Simply faster.

The simple blade replacement system with automatic adjustment function eliminates the need to adjust the blade cutting circle diameter.

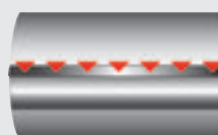

Operating principle: classic planer blade

The blade meets the wood head-on, resulting in a "chopping cut" that leaves behind chatter marks and splinters. The high forces exerted on the drive shaft also increase tool wear.

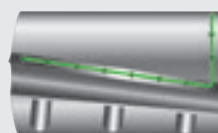

Operating principle: spiral blade

Initial contact is made over a small surface and force is then transferred smoothly across the entire width of the blade. The angled blade strips off the wood more gently and decreases tool wear.

Planing

One-handed planer EHL 65 EQ

EHL 65 EQ



Modified slightly. Improved decisively.

- ▶ Only 2.4 kg, compact height, soft grip on handle and chip depth adjustment, additional grips for better support
- ▶ Quiet: The spiral blade reduces the noise level considerably
- ▶ Maximum 4 mm planing depth and 23 mm rebate depth for more speed and flexibility
- ▶ Variable chip depth adjustment and spiral blade for high surface quality in diverse application areas

Technical data

Power consumption (W)	720
Planer shaft speed (min ⁻¹)	15.600
Planing width (mm)	65
Planing depth (mm)	0 – 4
Max. rebate depth (mm)	23
Dust extraction connection dia. (mm)	27
Weight (kg)	2,4

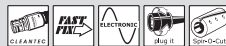

= Electronic

Items included

parallel side fence, operation tool, in SYSTAINER SYS 2 T-LOC

EHL 65 EQ GB 240V

Order no.

574560

EHL 65 EQ GB 110V

574561

Unique results.

The EHL 65 EQ operates with a drawing cut to produce a particularly fine planing pattern. No chatter marks. No rework.

System accessories from page 318





HL 850

Planer with no limits.

- ▶ Planing to the edge, single-bearing planing head for unlimited rebating depths
- ▶ Precision chamfering – with 90° V groove in the planer foot
- ▶ Precision – stepless cutting depth
- ▶ Greater precision when rebating and trimming

Technical data	
Power consumption (W)	850
Planer shaft speed (min ⁻¹)	11.000
Planing width (mm)	82
Planing depth (mm)	0 – 3,5
Dust extraction connection dia. (mm)	36
Weight (kg)	3,9
Max. rebate depth	∞



■ = Electronic

Items included	Order no.
parallel side fence, rebate depth stop, extraction adapter, operation tool, in SYSTAINER SYS 3 T-LOC	
HL 850 EB-Plus GB 240V	574555
HL 850 E-Plus GB 110V	574552

System accessories
from page 318

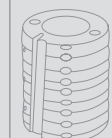

Texturing surfaces.

Individual planer heads for creating textured surfaces – replaced with a single hand movement.

Planing

Rustic planer heads

Narrow, wide or rustic waves.

Narrow, wide or rustic waves. Replacing the planing head for textured planing requires a single hand movement. Achieving attractive, natural wooden surfaces could not be easier.

Narrow



Wide

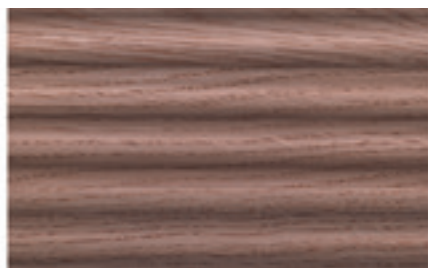

Rustic



Special planer heads for individually textured wooden surfaces.





PL 205 / PL 245

Hand-held planer with turbo chip ejection.

- ▶ Safe guidance due to ideal positioning of the handles and lengthy planer base
- ▶ Superior chip discharge efficiency with the "turbo" mechanism, providing clear visibility to the work piece
- ▶ Ideal method of planing depth adjustment by means of the front handle situated adjuster
- ▶ Safe, accurate chamfering of material made easy by the V-groove in the planer base



Technical data	PL 205	PL 245
Power consumption (W)	2.000	2.300
Idle engine speed (min ⁻¹)	13.500	13.000
Max. planing width (mm)	205	245
Adjustable planing depth (mm)	0 – 3	0 – 3
Weight (kg)	13	15,7



■ = Electronic

not available in Great Britain

With reliable guidance for an excellent planing pattern.

In modern wooden structures, more and more visible wooden surfaces are on show. The beam planers PL 205 and PL 245 offer the optimal prerequisites for clean, smooth surfaces with an excellent planing result.

System accessories
from page 319

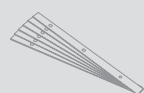

The Festool system.

Because things work better when everything fits together: rebating, trimming and texturing of skirting, trim, door rebates, beams or planks. Always with unique results. An entire system consisting of planer heads, stationary units and angle stops complements the integral planer program.



Planing

Accessories and consumable materials



07

Planing

System accessories

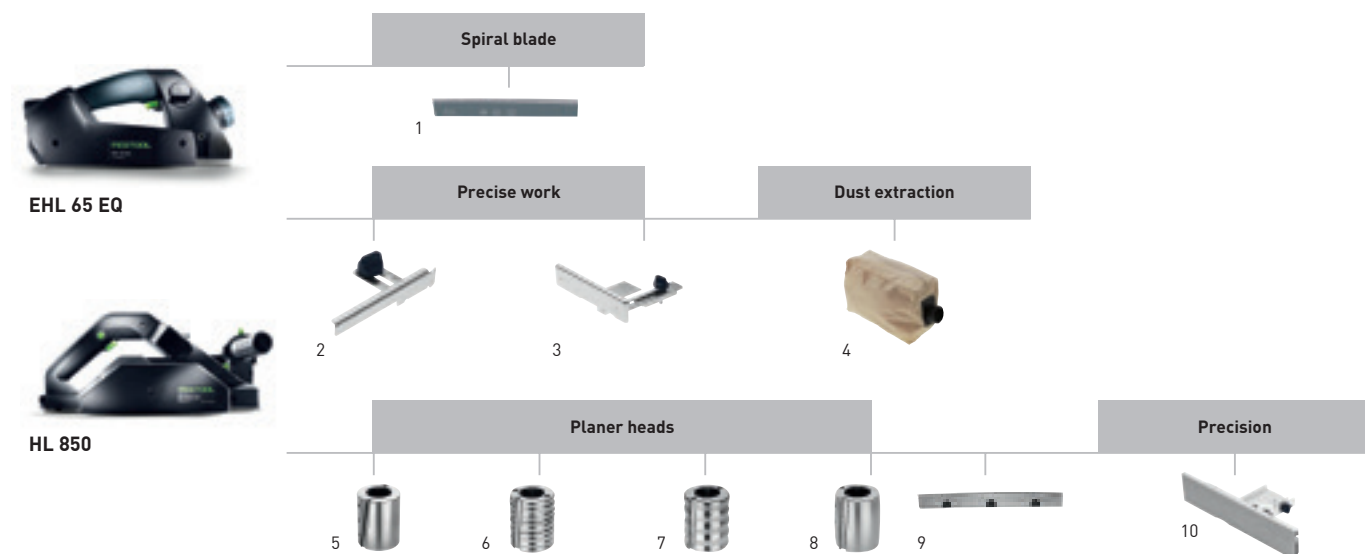

Accessories for one-handed planer EHL 65, planer HL 850

Denomination	Explanation	Order no.
1 Spiral blade HW 65	for EHL 65, HW version for the EHL 65, HW standard planer blades with 65 mm width, in self-service display pack	488503
2 Rebate depth stop FA-EHL	for EHL 65, for rebate depths of 0-23 mm, in self-service display pack	488543
Rebate depth stop FA-HL	for HL 850, for rebate depths of 0-30 mm, in self-service display pack	484512
3 Parallel side fence PA-EHL	for EHL 65, for side guidance, adjustable between 0 mm and 65 mm, in self-service display pack	488544
Parallel side fence PA-HL	for HL 850, for side guidance, adjustable between 0 mm and 82 mm, in self-service display pack	484513
4 Chip collection bag SB-EHL	for EHL 65, in carton	488566
Chip collection bag SB-HL	for HL 850, without suction adapter, in carton	484509
Extraction adapter AD-HL	for HL 850, for chip collection bag and suction hose with bushing, suction hose diameter 36 mm, in self-service display pack	484507
5 Planing head HK 82 SD	standard design, with HW carbide-tipped spiral blade HW 82 SD, in self-service display pack	484520
6 Planing head HK 82 RF	rustic design, fine, with spiral blade HS 82 RF, depth limiter, in self-service display pack	484521
7 Planing head HK 82 RG	for HL 850, rustic design, coarse, with HS spiral blade HS 82 RG, depth limiter, in self-service display pack	484522
8 Planing head HK 82 RW	for HL 850, rustic design, undulating, with HS spiral blade HS 82 RW, depth limiter, in self-service display pack	485331
9 Spiral blade HW 82 SD	for planer head HK 82 SD, HM standard design, HW standard planer blades with 82 mm width, in self-service display pack	484515
Spiral blade HS 82 RF	for planer head HK 82 RF, HSS rustic design, fine, in self-service display pack	484518
Spiral blade HS 82 RG	for planer head HK 82 RG, HSS rustic design, coarse, in self-service display pack	484519
Spiral blade HS 82 RW	for planer head HK 82 RW, HSS rustic design, undulating, in self-service display pack	485332
10 Angle stop WA-HL	for HL 850 EB, can also be used as stop for bench unit SE-HL, for planing at angles of 0-45°, stop area (length x height) 350 x 70 mm, in carton	485018



PL 205



PL 245

Cutter block with two tri-metal reversible blades



1

Accessories for beam planer PL 205, PL 245

Denomination	Explanation	Order no.
1 Reversible cutter blade RN-PL 19x1x205 Tri. 6x	for PL 205 E, PLP 205 E, Tri-metal, dimensions 19 x 1 x 205 mm	769545
Reversible cutter blade RN-PL 19x1x245 Tri. 6x	for PL 245 E, PLP 245 E, Tri-metal, dimensions 19 x 1 x 245 mm	769546

07





Joining – DOMINO joining system

Overview of products and applications	322
DOMINO joining machines DF 500, DF 700	324
Accessories and consumable materials	326
The Festool system	

Joining – DOMINO joining system

Overview of products and applications

Page 324 ————— 325

The DOMINO system: Perfect for panel, frame and rack joints as well as narrow, wide, delicate and bulky workpieces. Dowel diameters ranging from 4 to 14 mm for unlimited jointing possibilities.

DF 500

DF 700



Applications

The DOMINO DF 500 joiner

Joining boards

Drawers, Ø 4 mm dowels or larger



Cabinet with Ø 5 and 6 mm dowels



Solid wood furniture with Ø 8 and 10 mm dowels



Solid wood furniture (e.g. beds) with Ø 12 and 14 mm dowels



rack joints

Lightweight frame construction (e.g. chairs) up to Ø 10 mm dowels



Stable frame construction (e.g. tables) with Ø 10 to 14 mm dowels



Frame and base structures



Frame joints

Furniture fronts with framework construction with Ø 8 and 10 mm dowels



Solid wood furniture with frame design



House doors and internal doors



Other applications

Joining thin strips, width 25 mm or more.



Joining round poles with the handrail fence.



Connecting wide cornices (e.g. solid wood panels)



Extremely appropriate

Appropriate

Technical data

Power consumption (W)	420	720
Max. routing depth (mm)	28	70
DOMINO slot cutter Ø (mm)	4, 5, 6, 8, 10	8, 10, 12, 14
Routing height adjustment (mm)	5 – 30	10 – 50
Mitre routing (°)	0 – 90	0 – 90
Weight (kg)	3,2	5,2

Every wooden joint has its advantages.
The DOMINO joining system combines them all.



The DOMINO long-hole principle.

Custom-fit alignment: The first domino is positioned in a precision cut elongated hole, the next dominos are inserted into wider holes with play so that the joint can be aligned effortlessly. The result is a stable joint, rotation-proof from the first domino.

Impressive time savings.

No complicated adjustments or measurements: with integral stop pins for positioning the machine quickly and accurately. It is easy to adapt the routing height and depth to different material thicknesses. When making solid joints, you can save up to half the time with the DOMINO XL.

Enormous variety of applications.

Two machines, domino sizes ranging from 4 to 14 mm in diameter, flexible adjustment options and compatible system accessories offer virtually unlimited joining possibilities. Even narrow strip material and round poles are easy to join.



Beechwood domino

Bear the Pan European Forest Council (PEFC) quality seal for wood products originating from sustainable, well-maintained, responsible forest cultivation.



Hardwood domino

Are weatherproof and resistant to insects and mould, making them ideal for outdoor applications. They are manufactured from wood from sustainably managed and monitored forests.

Joining – DOMINO joining system

Joining machine DOMINO DF 500



product
design
award

2006

DOMINO DF 500



More precise joints.

- ▶ Varied use with dowel sizes from 4 x 20 mm to 10 x 50 mm
- ▶ Patented routing principle unique to hand-held machines for accurate work with no kickbacks
- ▶ Stops that are quick and easy to adjust, for accurate results
- ▶ Ergonomic shape for ease of operation in any position

Technical data

Power consumption (W)	420
Idle engine speed (min ⁻¹)	25.500
Depth stop for routing depth (mm)	12, 15, 20, 25, 28
Max. routing depth (mm)	28
DOMINO slot cutter dia. (mm)	4, 5, 6, 8, 10
Routing height adjustment (mm)	5 – 30
Mitre routing [°]	0 – 90
Dust extraction connection dia. (mm)	27
Weight (kg)	3,2



Items included

DOMINO cutter D5, support bracket, operation tool,
in SYSTEMAINER SYS 2 T-LOC

DF 500 Q-Plus GB 240V

Order no.

574327

DF 500 Q-Plus GB 110V

574329

DF 500 Q-Set GB 240 V

trim stop, cross stop

574429

A system that joins everything up.

The DOMINO DF 500 is particularly handy and offers almost unlimited jointing possibilities. No matter whether it is panel or cabinet construction, for lightweight frame or rack joints – the DF 500 impresses with maximum precision and simple handling.

System accessories
from page 328

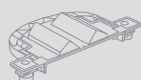

Dominos shown starting on
page 328



Joining – DOMINO joining system

Joining machine DOMINO XL DF 700



product
design award

2012

DOMINO XL DF 700



08

Extra mobile. Extra stable.

- ▶ Maximum stability of joints up to a domino size of 14 x 140 mm
- ▶ Patented routing principle unique to hand-held machines for accurate work with no kickbacks
- ▶ Saves more time compared to a stationary machine
- ▶ Stops that are quick and easy to adjust, for accurate results

Technical data

Power consumption (W)	720
Idle engine speed (min ⁻¹)	21.000
Depth stop for routing depth (mm)	15 – 70
Max. routing depth (mm)	70
DOMINO slot cutter dia. (mm)	8, 10, 12, 14
Routing height adjustment (mm)	10 – 50
Mitre routing (°)	0 – 90
Dust extraction connection dia. (mm)	27
Weight (kg)	5,2



■ = Electronic

Items included

DF 700 EQ-Plus GB 240V
DOMINO cutter D 12, support bracket, 2 x empty dowel box, operation tool,
in SYSTAINER SYS 5 T-LOC

Order no.

574420

The quickest way to join large workpieces.

Comes to the workpiece and not vice versa: DOMINO XL. Quick, simple, precise and extremely stable – with measurably shorter tooling times and up to 50% time-saving in comparison to stationary machines. The DOMINO XL is therefore ideally suited for furniture and door construction and solid wood joints.

System accessories
from page 330

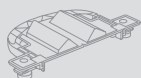

Dominos shown starting on
page 330



The Festool system.

Because things work better when everything fits together: The DOMINO jointing system offers the right dowels and cutters for every application. Even complicated shapes are easy to join using different stops compatible with both DOMINO jointers.

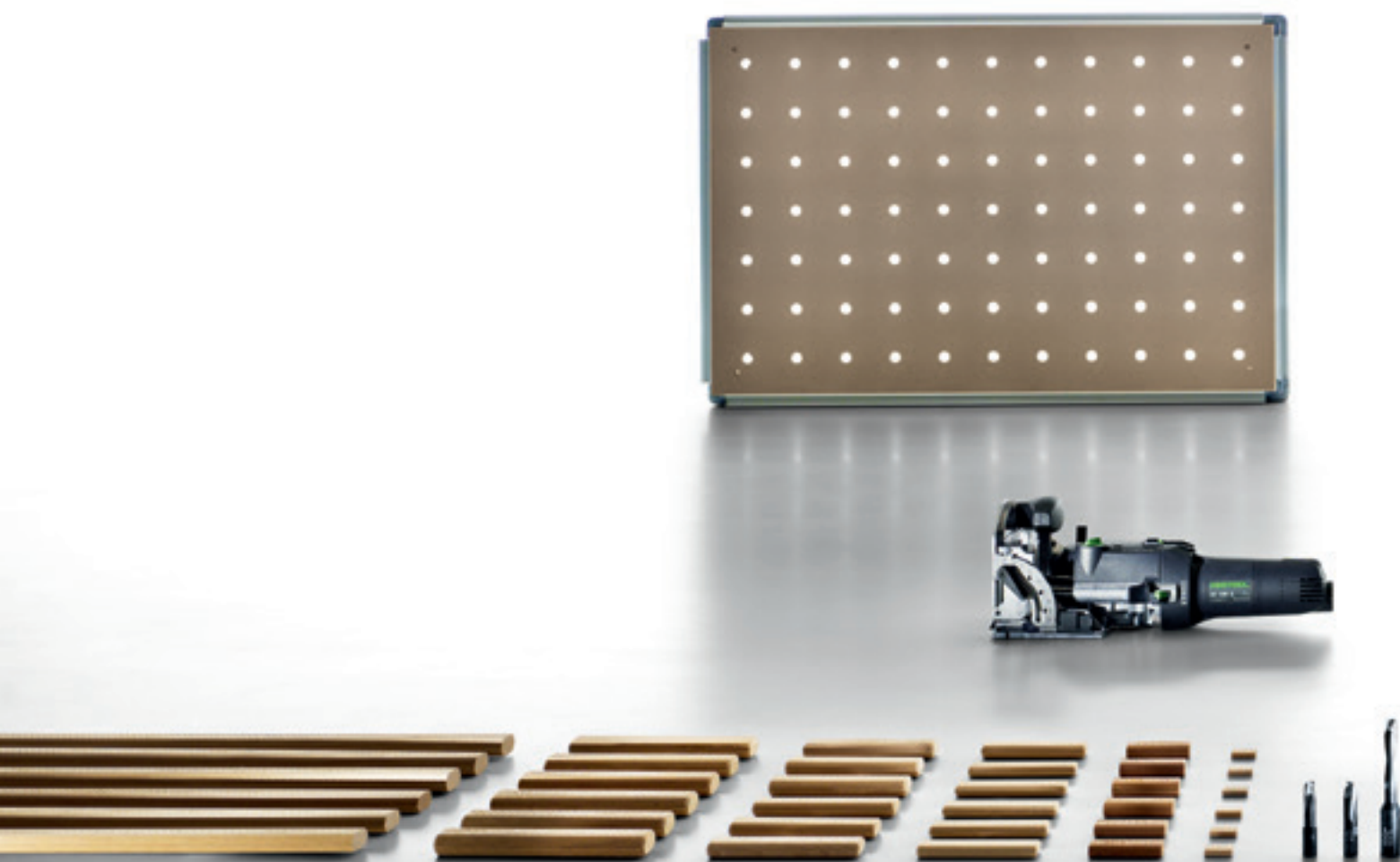

Joining – DOMINO joining system

Accessories and consumable materials



Joining – DOMINO joining system

System accessories

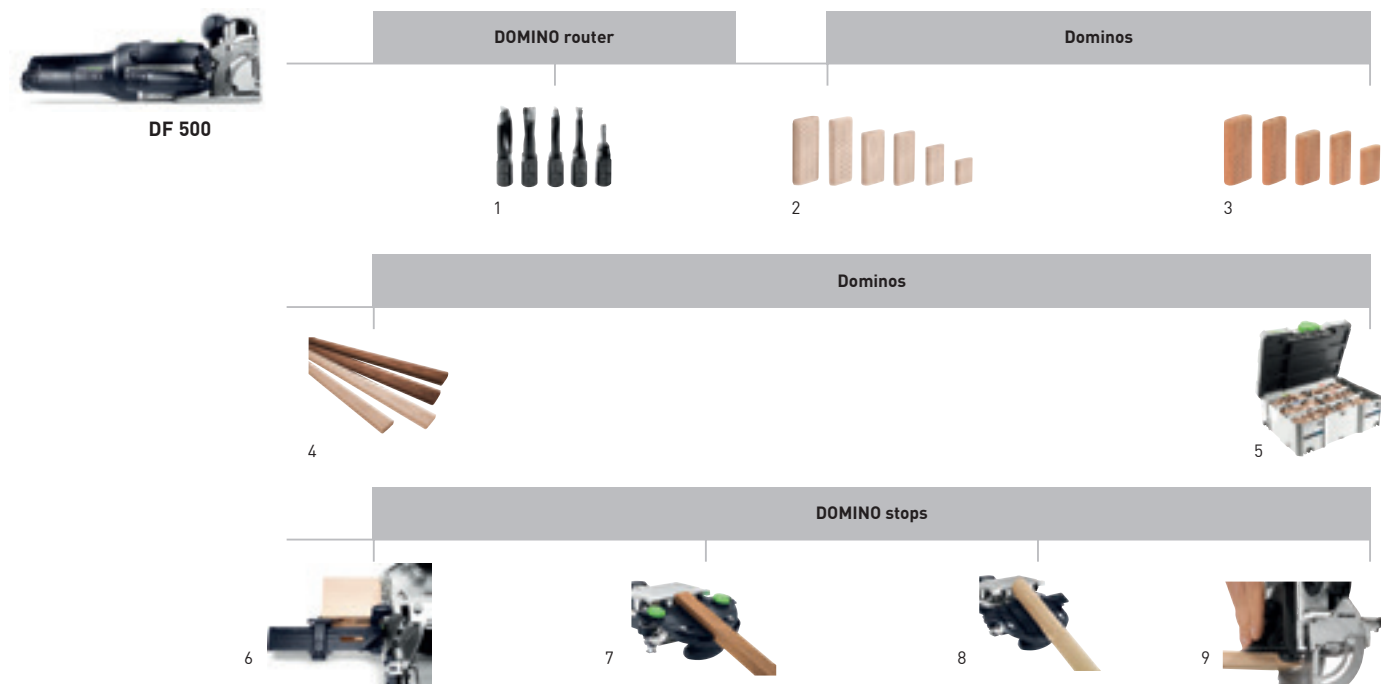

Accessories for DOMINO DF 500 joining machine

Denomination	Explanation	Order no.
1 Router D 4-NL 11 HW-DF 500	D 4 mm, NL 11 mm, in self-service display pack	495663
Router D 5-NL 20 HW-DF 500	D 5 mm, NL 20 mm, in self-service display pack	493490
Router D 6-NL 28 HW-DF 500	D 6 mm, NL 28 mm, in self-service display pack	493491
Router D 8-NL 28 HW-DF 500	D 8 mm, NL 28 mm, in self-service display pack	493492
Router D 10-NL 28 HW-DF 500	D 10 mm, NL 28 mm, in self-service display pack	493493
2 Beechwood domino D 4x20/450 BU	dimensions 4 x 20 mm, qty. in pack 450 piece(s), in self-service display pack	495661
Beechwood domino D 5x30/300 BU	dimensions 5 x 30 mm, qty. in pack 300 piece(s), in self-service display pack	494938
Beechwood domino D 5x30/1800 BU	dimensions 5 x 30 mm, qty. in pack 1.800 piece(s), in carton	493296
Beechwood domino D 6x40/190 BU	dimensions 6 x 40 mm, qty. in pack 190 piece(s), in self-service display pack	494939
Beechwood domino D 6x40/1140 BU	dimensions 6 x 40 mm, qty. in pack 1.140 piece(s), in carton	493297
Beechwood domino D 8x40/130 BU	dimensions 8 x 40 mm, qty. in pack 130 piece(s), in self-service display pack	494940
Beechwood domino D 8x40/780 BU	dimensions 8 x 40 mm, qty. in pack 780 piece(s), in carton	493298
Beechwood domino D 8x50/100 BU	dimensions 8 x 50 mm, qty. in pack 100 piece(s), in self-service display pack	494941
Beechwood domino D 8x50/600 BU	dimensions 8 x 50 mm, qty. in pack 600 piece(s), in carton	493299
Beechwood domino D 10x50/85 BU	dimensions 10 x 50 mm, qty. in pack 85 piece(s), in self-service display pack	494942
Beechwood domino D 10x50/510 BU	dimensions 10 x 50 mm, qty. in pack 510 piece(s), in carton	493300

Accessories for DOMINO DF 500 joining machine

Denomination	Explanation	Order no.
3 Sipo domino D 5x30/300 MAU	dimensions 5 x 30 mm, qty. in pack 300 piece(s), in self-service display pack	494869
Sipo domino D 5x30/900 MAU	dimensions 5 x 30 mm, qty. in pack 900 piece(s), in carton	494859
Sipo domino D 6x40/190 MAU	dimensions 6 x 40 mm, qty. in pack 190 piece(s), in self-service display pack	494870
Sipo domino D 6x40/570 MAU	dimensions 6 x 40 mm, qty. in pack 570 piece(s), in carton	494860
Sipo domino D 8x40/130 MAU	dimensions 8 x 40 mm, qty. in pack 130 piece(s), in self-service display pack	494871
Sipo domino D 8x40/390 MAU	dimensions 8 x 40 mm, qty. in pack 390 piece(s), in carton	494861
Sipo domino D 8x50/100 MAU	dimensions 8 x 50 mm, qty. in pack 100 piece(s), in self-service display pack	494872
Sipo domino D 8x50/300 MAU	dimensions 8 x 50 mm, qty. in pack 300 piece(s), in carton	494862
Sipo domino D 10x50/85 MAU	dimensions 10 x 50 mm, qty. in pack 85 piece(s), in self-service display pack	494873
Sipo domino D 10x50/255 MAU	dimensions 10 x 50 mm, qty. in pack 255 piece(s), in carton	494863
4 DOMINO beechwood D 8x750/36 BU	dimensions 8 x 750 mm, qty. in pack 36 piece(s), in carton	498686
DOMINO beechwood D 10x750/28 BU	dimensions 10 x 750 mm, qty. in pack 28 piece(s), in carton	498687
DOMINO Sipo D 8x750/36 MAU	dimensions 8 x 750 mm, qty. in pack 36 piece(s), in carton	498690
DOMINO Sipo D 10x750/28 MAU	dimensions 10 x 750 mm, qty. in pack 28 piece(s), in carton	498691
5 Beechwood domino range DS 4/5/6/8/10 1060x BU	for DF 500, DOMINO 4 x 20, 5 x 30, 6 x 40, 8 x 40, 8 x 50, 10 x 50 mm and DOMINO router cutters for sizes 4, 5, 6, 8 and 10, dimensions 396 x 296 x 157,5 mm, qty. in pack 1.060 piece(s), in SYSTAINER SYS 2 T-LOC	498899
6 Cross stop QA-DF 500/700	for DF 500 and DF 700, for repeat hole spacing between 100 and 205 mm, items included: A left and right cross stop, for precise positioning of milling grooves 100-205 mm away from edges, in self-service display pack	498590
7 Trim stop LA-DF 500/700	for DF 500 and DF 700, for strip material with widths between 22 and 70 mm, qty. in pack 1 piece(s), in self-service display pack	493487
8 Handrail fence RA DF 500/700	for DF 500 and DF 700, for round wooden poles, dia. 35 – 60 mm, for precise routing of round poles Ø 35 – 60 mm, in self-service display pack	494847
9 Additional stop ZA-DF 500	for DF 500, support widener and side stop, for reducing the dowel centre from 37 mm to 20 mm, for secure positioning of the router, in carton	495666

Joining – DOMINO joining system

System accessories



DF 700

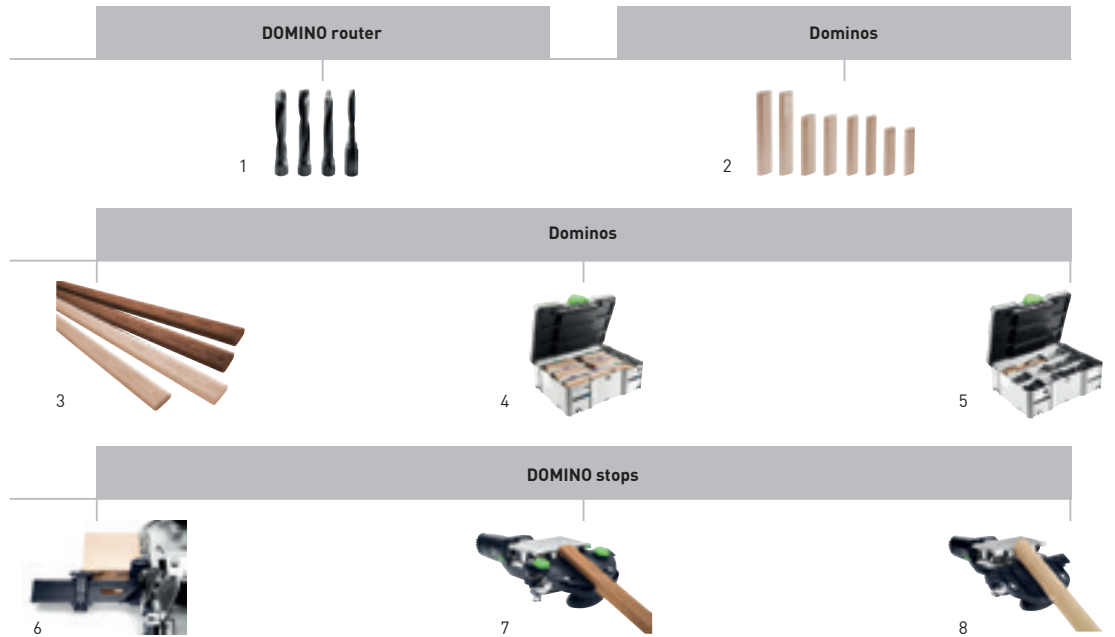

Accessories for DOMINO XL DF 700 joining machine

Denomination	Explanation	Order no.
1 DOMINO router D 8-NL 50 HW-DF 700	routing tools with threaded supports for the DOMINO joining machine XL DF 700, D 8 mm, NL 50 mm, in self-service display pack	497868
DOMINO router D 10-NL 70 HW-DF 700	routing tools with threaded supports for the DOMINO joining machine XL DF 700, D 10 mm, NL 70 mm, in self-service display pack	497869
DOMINO router D 12-NL 70 HW-DF 700	routing tools with threaded supports for the DOMINO joining machine XL DF 700, D 12 mm, NL 70 mm, in self-service display pack	497870
DOMINO router D 14-NL 70 HW-DF 700	routing tools with threaded supports for the DOMINO joining machine XL DF 700, D 14 mm, NL 70 mm, in self-service display pack	497871
2 Beechwood domino D 8x80/190 BU	dimensions 8 x 80 mm, qty. in pack 190 piece(s), in carton	498212
Beechwood domino D 8x100/150 BU	dimensions 8 x 100 mm, qty. in pack 150 piece(s), in carton	498213
Beechwood domino D 10x80/150 BU	dimensions 10 x 80 mm, qty. in pack 150 piece(s), in carton	498214
Beechwood domino D 10x100/120 BU	dimensions 10 x 100 mm, qty. in pack 120 piece(s), in carton	498215
Beechwood domino D 12x100/100 BU	dimensions 12 x 100 mm, qty. in pack 100 piece(s), in carton	498216
Beechwood domino D 12x140/90 BU	dimensions 12 x 140 mm, qty. in pack 90 piece(s), in carton	498217
Beechwood domino D 14x75/104 BU	for processing using the DOMINO XL DF 700 joining machine, ideal in combination with the DOMINO corner connectors (precisely matched to the milling depth of the corner connectors), provides further load transfer in addition to the connectors, qty. in pack 104 piece(s), dimensions 14 x 75 mm, in carton	201499
Beechwood domino D 14x100/80 BU	dimensions 14 x 100 mm, qty. in pack 80 piece(s), in carton	498218
Beechwood domino D 14x140/70 BU	dimensions 14 x 140 mm, qty. in pack 70 piece(s), in carton	498219

Accessories for DOMINO XL DF 700 joining machine

Denomination	Explanation	Order no.
3 DOMINO beechwood D 8x750/36 BU	dimensions 8 x 750 mm, qty. in pack 36 piece(s), in carton	498686
DOMINO beechwood D 10x750/28 BU	dimensions 10 x 750 mm, qty. in pack 28 piece(s), in carton	498687
DOMINO beechwood D 12x750/22 BU	dimensions 12 x 750 mm, qty. in pack 22 piece(s), in carton	498688
DOMINO beechwood D 14x750/18 BU	dimensions 14 x 750 mm, qty. in pack 18 piece(s), in carton	498689
DOMINO Sipo D 8x750/36 MAU	dimensions 8 x 750 mm, qty. in pack 36 piece(s), in carton	498690
DOMINO Sipo D 10x750/28 MAU	dimensions 10 x 750 mm, qty. in pack 28 piece(s), in carton	498691
DOMINO Sipo D 12x750/22 MAU	dimensions 12 x 750 mm, qty. in pack 22 piece(s), in carton	498692
DOMINO Sipo D 14x750/18 MAU	dimensions 14 x 750 mm, qty. in pack 18 piece(s), in carton	498693
4 Beechwood DOMINO XL assortment DS/XL D8/D10 306x BU	for DOMINO XL, DOMINO 8 x 50, 8 x 80, 8 x 100, 10 x 50, 10 x 80, 10 x 100 mm and DOMINO XL cutter for sizes 8 and 10, dowel range, qty. in pack 306 piece(s), in SYSTAINER SYS 2 T-LOC	498204
Beechwood DOMINO XL assortment DS/XL D12/D14 128x BU	for DOMINO XL, DOMINO 12 x 100, 12 x 140, 14 x 100, 14 x 140 mm and DOMINO XL cutter for size 14, dowel range, qty. in pack 128 piece(s), in SYSTAINER SYS 2 T-LOC	498205
5 SYSTAINER T-LOC SORT-SYS 2 TL DOMINO	empty Systainer SYS 2 T-LOC, contains 3 boxes with flexible compartment division for individual filling of DOMINOs, in SYSTAINER SYS 2 T-LOC	498889
6 Cross stop QA-DF 500/700	for DF 500 and DF 700, for repeat hole spacing between 100 and 205 mm, items included: A left and right cross stop, for precise positioning of milling grooves 100-205 mm away from edges, in self-service display pack	498590
7 Trim stop LA-DF 500/700	for DF 500 and DF 700, for strip material with widths between 22 and 70 mm, qty. in pack 1 piece(s), in self-service display pack	493487
8 Handrail fence RA DF 500/700	for DF 500 and DF 700, for round wooden poles, dia. 35 – 60 mm, for precise routing of round poles Ø 35 – 60 mm, in self-service display pack	494847

Joining – DOMINO joining system

Corner and flat connectors for the DOMINO XL DF 700

Revolutionary simplicity. Simply revolutionary.

The DOMINO corner and flat connectors:

For perfect timber joints, faster than ever before. Quick and easy to create using the 14 mm cutter and the DOMINO XL DF 700.

eXtremely fast:

- ▶ No complex measuring and marking – simple routing using machine stops or pencil markings
- ▶ No template or other accessories needed
- ▶ Huge time savings thanks to fewer steps

eXtremely stable:

- ▶ Domino and fixed clamp for a strong joint
- ▶ Large pulling and tightening distance
- ▶ Very high pull-out and load forces

eXtremely flexible:

- ▶ Connection can if required be rapidly released
- ▶ For frame, framework and worktop connections starting from 30 mm material thickness
- ▶ With cover caps in three colours for a high-quality corner connection appearance





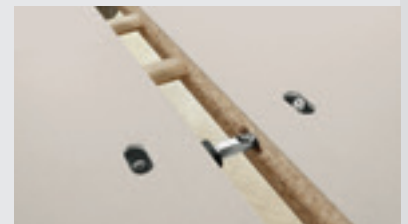









The corner connectors: These are not only extremely quick to fit and extremely stable, but also have a high-quality appearance: The only visible portion is the cover cap, which is clipped over the oval-shaped dowel hole typical of domino connectors.



The flat connectors: High tension, secure locking and a powerful, stable connection.

Modular connector components –

The table provides an overview of the components required for each corner connection and flat connection.

		  E ¹ F ¹				  E ¹ F ¹	
	Anchor bolt: Spreads the split anchor and acts as a counter bearing for the cross anchor.	1 x			Domino birch D 14 x 75	x ¹	x ¹
	Self-drawing expansion bolt – for a secure hold in the workpiece	1 x			Cover cap: available in silver, light brown or dark brown	1 x ¹	2 x ¹
	Cross anchors: both for anchor bolts (corner connectors) and double-headed bolts (flat connectors)	1 x	2 x		EV/32 corner connector set: All individual components for 32 corner connectors in one set (optional components not included).	Set	
	Widening: This is optionally clipped around the cross anchor to prevent the cross anchor from being drawn into soft materials (e.g. kitchen worktops).		2–4 x ²		FV/16 flat connector set: All individual components for 16 flat connectors in one set (optional components not included).		Set
	Double-headed bolt: Can be fitted with one or two dowel clips		1 x	* E = Corner connector; F = Flat connector ¹ optional ² or (as an option) up to 4 enlarging clips per flat connector (2 for each cross anchor)			



DF 700

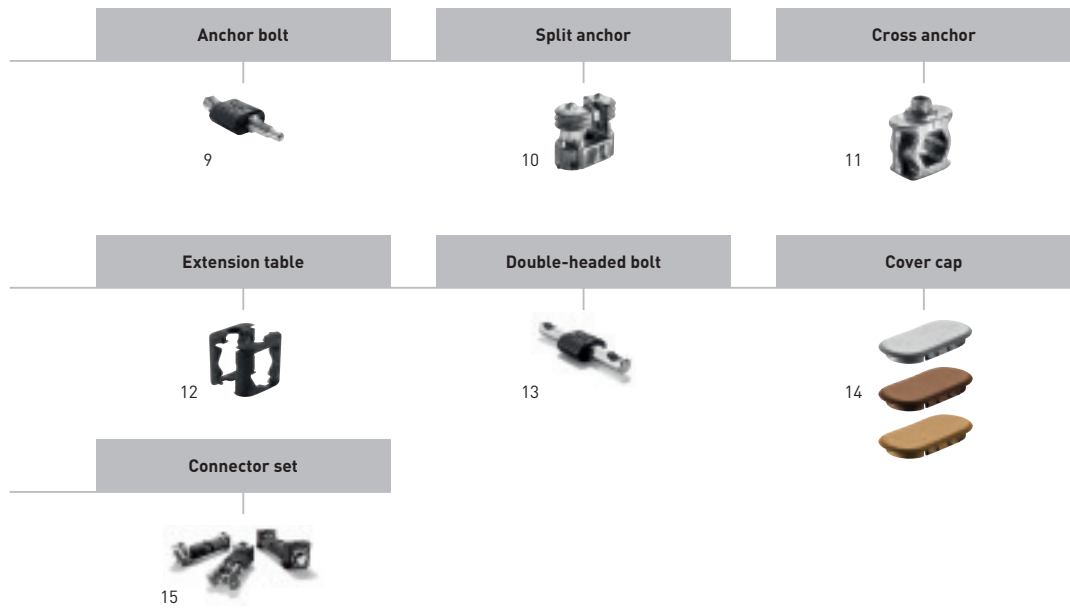

DOMINO corner and flat connector

Denomination	Explanation	Order no.
9 Anchor bolt SV-AB D14/32	for processing using the DOMINO XL DF 700 joining machine, in conjunction with SV-SA D14 split anchors and SV-QA D14 cross anchors for creating corner connections, for frame and rack joints at material thicknesses of 30 mm or higher, 64 x dowel half-shells, qty. in pack 32 piece(s), in carton	201350
10 Split anchor SV-SA D14/32	for processing using the DOMINO XL DF 700 joining machine, in conjunction with SV-AB D14 anchor bolts and SV-QA D14 cross anchors for creating detachable corner connections, for frame and rack joints at material thicknesses of 30 mm or higher, qty. in pack 32 piece(s), in carton	201349
11 Cross anchor SV-QA D14/32	for processing using the DOMINO XL DF 700 joining machine, in conjunction with SV-SA D14 split anchors and SV-AB D14 anchor bolts for creating corner connections, in conjunction with SV-DB D14 double-headed bolts for creating flat connections, at a material thickness of 30 mm or higher, acts as a counter bearing and tightening element for anchor bolts or double-headed bolts, with soft or porous material such as chipboard, the use of the cross anchor expander SV-V D14 is recommended [for material thickness 35 mm and greater – stops the cross anchor being pulled into the material], 32 x set screws, qty. in pack 32 piece(s), in carton	201351
12 Extension table SV-V D14/32	for SV-QA D14 cross anchors, for processing cross anchors for improved pressure distribution for applications in porous or soft materials such as kitchen worktops, prevents the cross anchor being drawn into the material, 64 half-shells for widening 32 cross anchors, qty. in pack 32 piece(s), in carton	201498
13 Double-headed bolt SV-DB D14/16	for processing using the DOMINO XL DF 700 joining machine, in conjunction with 2x SV-QA D14 cross anchors (and optional SV-V D14 widening clips for soft materials) for creating flat connections in furniture manufacturing, 64 x dowel half-shells, qty. in pack 16 piece(s), in carton	201352
14 Cover cap SV-AK D14 str/32	for processing using the DOMINO XL DF 700 joining machine, plastic cover caps for closing D14 dowel cross-cuts, colour: Lacquered silver, qty. in pack 32 piece(s), in self-service display pack	201354
Cover cap SV-AK D14 brn1/32	for processing using the DOMINO XL DF 700 joining machine, plastic cover caps for closing D14 dowel cross-cuts, colour: Dark brown, qty. in pack 32 piece(s), in self-service display pack	201355
Cover cap SV-AK D14 brn2/32	for processing using the DOMINO XL DF 700 joining machine, plastic cover caps for closing D14 dowel cross-cuts, colour: Light brown, qty. in pack 32 piece(s), in self-service display pack	201356
15 Connector set EV/32-Set	for frame and rack joints at material thicknesses of 30 mm or higher, complete set consisting of anchor bolts, split anchors and cross anchors for 32 corner connectors, 32 anchor bolts, SV-AB D14, 32 cross anchors, SV-QA D14, 32 split anchors, SV-SA D14, in carton	203420
Connector set FV/16-Set	complete set for 16 flat connectors consisting of double-headed bolts, cross anchors and wideners, 16 double-headed bolts, SV-DB D14, 32 cross anchors, SV-QA D14, SV-V D14 widener for 32 cross anchors, in carton	203421
DOMINO connector range SV-SYS D14	for processing using the DOMINO XL DF 700 joining machine, includes corner connectors and flat connectors incl. cover caps and DOMINO wooden dowels, required accessories: DOMINO cutter D 14 (497871), 32 anchor bolts, SV-AB D14, 16 double-headed bolts, SV-DB D14, 32 split anchors, SV-SA D14, 32 x Domino birch D 14 x 75, 2 x 32 cross anchors, SV-QA D14, SW 4 pin wrench for tightening the set screws, SV-V D14 widener for 32 cross anchors, 32 cover caps, silver, SV-AK D14 str, 32 cover caps, dark brown, SV-AK D14 brn1, 32 cover caps, light brown, SV-AK D14 brn2, in SYSTAINER SYS 2 T-LOC	201353



Edging

Overview of products and applications	336
Edge bander CONTURO KA 65, KP 65/2	338
Semi-stationary edge bander AP-KA 65, MFT/3 CONTURO	340
Accessories and consumable materials	342
The Festool system	

Edging

Overview of products and applications

Page 338 ————— 341

Edging curves, radii, convex and concave shapes is easy with the CONTURO. Even mitred edges can be cut to an outstanding quality with the stationary unit. Quick, easy and clean – ideal for shaped parts and small batches. Suitable for machining all types of wood, plastic or melamine edging with a height of 18-65 mm and edge strength of 0.5-3.0 mm (depending on material). The CONTURO is packed away safely in a SYSTAINER, extremely mobile and delivers a perfect edge quality, even in combination with system accessories.



Applications

CONTURO edge bander **Semi-stationary edge banding**

Gluing with the edge bander

Affixing straight edging	<input checked="" type="radio"/>	<input type="radio"/>
Edging concave and convex moulded parts	<input checked="" type="radio"/>	<input type="radio"/>
Gluing circular sections	<input checked="" type="radio"/>	<input type="radio"/>
Edging inner corners	<input checked="" type="radio"/>	<input type="radio"/>

Stationary gluing of edges

Affixing narrow and straight edging	<input type="radio"/>	<input checked="" type="radio"/>
Affixing wide and straight edging	<input checked="" type="radio"/>	<input checked="" type="radio"/>
Edging small moulded parts	<input type="radio"/>	<input checked="" type="radio"/>
Edging mitre joints	<input type="radio"/>	<input checked="" type="radio"/>

Extremely appropriate **Appropriate**

Technical data

Power consumption (W)	1.200		
Edge height (mm)	18 – 65		
Edge thickness (mm)	0,5 – 3,0*		
Inner radius (mm)	> 50		
Warm-up time (min)	8		
Melting temperature (°C)	100 – 210		
Infeed speed (m/min)	2/4		
Safety class	1		
Weight (kg)	7,9		

* heavily dependent on the material



Working with MFT



Working with the VAC SYS



Preparing the workpiece



Perfect edge finish

SYSTEM

The perfect edge. The CONTURO in a system.

At the heart of the system, the CONTURO is responsible for the gluing process while the surrounding system components perform all other working steps. From cutting and milling chipboard to size or applying glue, pressing down edging, cutting and flush trimming, smoothing and polishing – the Festool system operates with a level of professionalism and clean quality that only bench-mounted machines can achieve.



CONTURO

Gluing edging

09



Adhesives



Trimming edging



Special accessories



Stationary tasks

ACCESSORIES

Edging

Edge bander CONTURO KA 65



CONTURO KA 65



The basis for the perfect edge.

Versatile and easy to operate, the CONTURO represents a genuine solution for manufacturing individual moulded parts, as well as affixing edging to workpieces or furniture components produced in small batches. Packed in a SYSTAINER, the CONTURO is also suitable for mobile use as well as manufacturing edging in situ with a perfect quality finish.

The start of the perfect edge.

- ▶ Easy, clean and efficient working progress and patented cartridge gluing system for quick colour changes
- ▶ Precision glue application for a perfect join quality and maximum adhesion
- ▶ Nozzle system that is easy to clean, machine housing does not heat up, allowing safe working progress
- ▶ Adhesive melts according to requirements and does not boil, discolour or deteriorate

Technical data

Power consumption (W)	1.200
Edge height (mm)	18 – 65
Edge thickness (mm)	0,5 – 3
Inner radius (mm)	> 50
Heating time (min)	8
Melting temperature (°C)	100 – 210
Feed speed (m/min)	2/4
Safety class	I
Weight (kg)	7,9



Items included	Order no.
front handle, 4 x EVA adhesive, natural, in SYSTAINER SYS 4 T-LOC	
KA 65 Plus GB 240V	574606
KA 65 Set GB 240V	574614
edge trimming set SYS KB-KA 65	

System accessories from page 344





KP 65/2



The precise cut.

- ▶ Ergonomic handle location for easy, effortless trimming, even on thick edging
- ▶ Patented eccentric fine adjustment for precision impact trimming
- ▶ Tabletop on both sides of the trimming machine allows the user to trim left and right panel edges from above – with a perfect view of the workpiece
- ▶ Impact trimming function (for round table) and trimming of panel edges (final trimming) with a single machine

Technical data

Trimming height (mm)	65
Trimming thickness (mm)	2

Items included

KP 65/2
in carton

Order no.

499896

Flush trimming.

The protruding edging is trimmed with the Festool trimming machine KP 65/2: Insert the edge band between the trimming blades, move the trimming machine up to the stop pin, position parallel to the workpiece and press the handles together.

Edging

Adapter plate AP-KA 65



AP-KA 65



Stationary gluing.

Stationary work with the CONTURO. Not a problem! With the adapter plate AP-KA 65. This allows not only the trimming of straight edges and curves, but also slanted edges at 90°-45° angles.

Swivel-mounted stationary edging.

- ▶ For mounting the edge bander on a workbench
- ▶ Installation of adapter plate in a self-constructed table frame or in intended MFT perforated board
- ▶ For small batches, straight edges, free form elements and gluing inclined edges, angle from 0-47°

Technical data

Dimensions length x width (mm)	254 x 420
Min. installation height (mm)	150
Cutting angle adjustment (°)	0 - 47

Items included

Items included	Order no.
AP-KA 65 mounting plate for edge bander complete with 15 sliding guides, additional roll, in carton	500175
GP-MFT/3 KA65 15x in self-service display pack	500367



MFT/3 CONTURO



1 table. 1000 possibilities.

- ▶ For mounting the edge bander on a workbench
- ▶ Sliding guides for guiding the workpiece safely
- ▶ Allows the user to swivel the machine (0-47°) in the bench and position the workpiece horizontally during edging – for convenient and safe guidance, even with larger objects

Technical data

Table dimensions (mm)	1.157 x 773
Work height (mm)	900
Swivel-mounted edge bander (°)	47
Weight (kg)	29

Items included

MFT/3 Conturo-AP
adapter plate AP-KA 65, cross brace QT-MFT/3, in carton

Order no.

500869

Stationary unit for edge gluing.

Stationary edging? Yes, with the MFT/3 CONTURO – a special multifunction table for the CONTURO KA 65. Simply insert the edge bander in the multifunction table MFT/3 CONTURO via an adapter plate. As a result, not only straight edges and curves can be trimmed, but also sloping edges. The CONTURO KA 65 can be swivel-mounted in the stationary unit from 90° – 45°.

The Festool system.

As the basis for the perfect edge, the CONTURO assumes the gluing process. Its system completes all the other steps. From the glue application, pressing the edges, trimming to smoothing down and polishing – the Festool system makes everything possible in an equally professional and clean quality which was previously only possible with bench-mounted machines.



Edging

Accessories and consumable materials

System accessories

344



Edging

System accessories



CONTURO KA 65

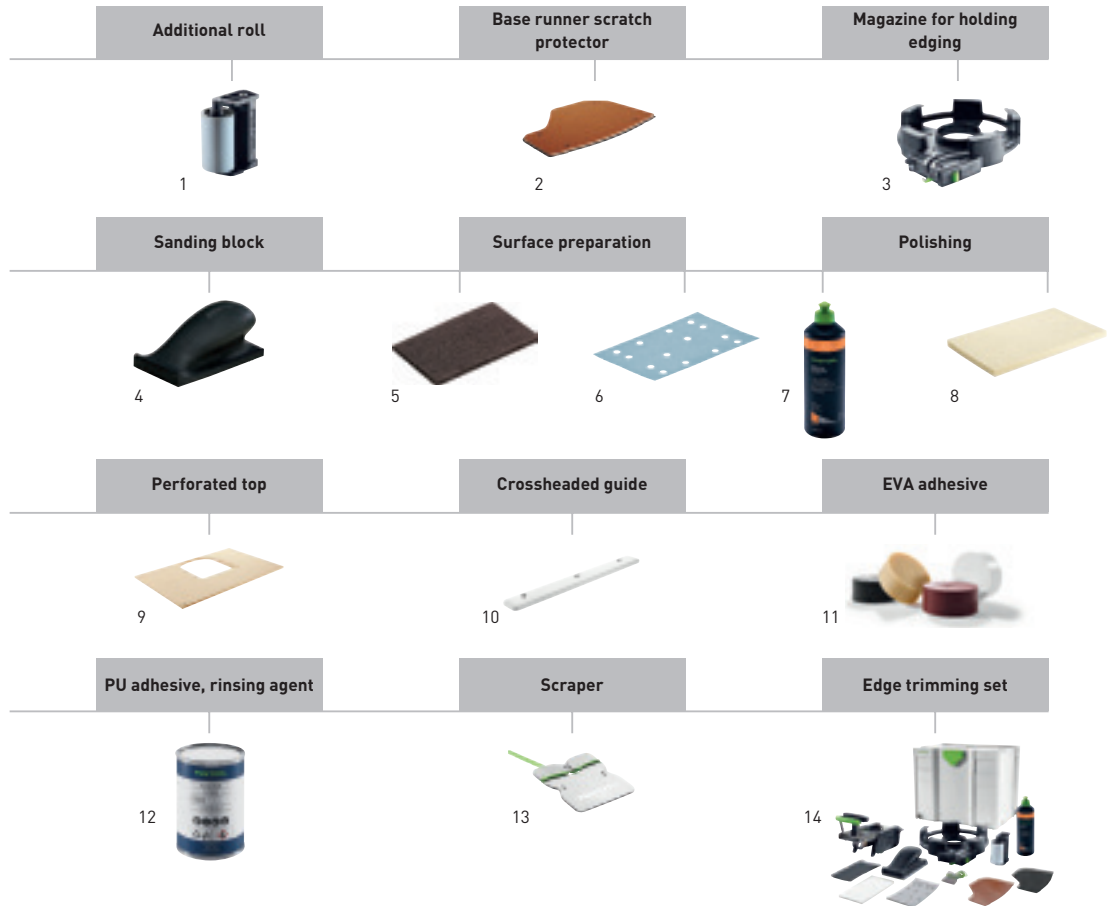

Accessories for edge bander CONTURO KA 65

Denomination	Explanation	Order no.
1 Additional roll ZR-KA 65	for KA 65, for affixing edging to tight curves and shaped parts, offers additional pressure point for applying more pressure on the edge of the board when glued, roll height 65 mm, in self-service display pack	499480
2 Scratch protector LAS-STF-KA 65	for KA 65, for using the edge bander on delicate or high-gloss surfaces, 4 x retaining screws, 3 x felt pads, in self-service display pack	499892
Spare felt EF-LAS-STF-KA 65 10x	for scratch protector LAS-STF-KA 65, for using the edge bander on delicate or high-gloss surfaces, qty. in pack 10 piece(s), in self-service display pack	499893
3 Magazine for holding edging KSP-KA 65	for KA 65, for the safe guidance of delicate and thin edging into the edge bander KA 65, safe guidance of long edges without damaging or soiling, max. edge lengths of 8 m (edge thickness of 2 mm) possible, max. edge height 45 mm, max. edge thickness 2 mm, in carton	499479
4 Sanding block HSK 80x133 H	hard, for attaching StickFix 80 x 133 mm abrasive sheets, in self-service display pack	495967
5 Sanding vlies STF 80x130/0 S800 VL/5	in combination with the MPA 5010 polishing agent for polishing high-gloss edge strips, grit 800, qty. in pack 5 piece(s), in self-service display pack	483582
6 Abrasive sheet STF 80x133 P220 GR/100	grit P220, qty. in pack 100 piece(s), in carton	497123
Abrasive sheet STF 80x133 P240 GR/100	grit P240, qty. in pack 100 piece(s), in carton	497124
Abrasive sheet STF 80x133 P280 GR/100	grit P280, qty. in pack 100 piece(s), in carton	497204
Abrasive sheet STF 80x133 P320 GR/100	grit P320, qty. in pack 100 piece(s), in carton	497125
7 Polishing agent MPA 5010 OR/0,5L	Speed Cut 1-step sanding polish, does not contain silicone, water-based, perfect in combination with a sheepskin pad or polishing pad (ORANGE), volume 500 ml, in plastic bottle	202048
8 Polishing felt PF-STF 80x133 STF H/5	for hand sanding block HSK 80 x 133, dimensions length x width 80 x 133 mm, qty. in pack 5 piece(s), in self-service display pack	499894

Accessories for edge bander CONTURO KA 65

Denomination	Explanation	Order no.
9 Perforated top LP-KA65 MFT/3	for KA 65, allows the user to swivel the machine (0-47°) in the bench in combination with the AP-KA 65 adapter plate and therefore position the workpiece horizontally during edging – for convenient and safe guidance, even with larger objects, dimensions length x width 1.102 x 718 mm, in carton	500366
10 Crossheaded guide GP-MFT/3 KA65 15x	for KA 65, replacement or extension slide plates for stationary use of the edge bander with the AP-KA 65 adapter plate in the MFT (with KA 65 perforated board, order no. 500366) or installed in a separate workbench, dimensions 255 x 31 mm, dimensions (L x W x H) 255 x 31 x 6 mm, qty. in pack 15 piece(s), in self-service display pack	500367
11 EVA adhesive, natural EVA nat 48x-KA 65	for KA 65, unfilled EVA adhesive – natural colour tone suitable for all types of decor, EVA universal adhesive with high melting point, high softening range of approx. 90°C, therefore also suitable for use on objects with a relatively high temperature resistance of -10°C to +75°C, chemical basis: Adhesive, resin, adhesive diameter 63 mm, adhesive height 26 mm, processing temperature 190°C, moisture resistance in accordance with D1, qty. in pack 48 piece(s), in carton	499812
EVA adhesive, white EVA wht 48x-KA 65	for KA 65, Unfilled EVA adhesive – perfect join quality on white decor, EVA universal adhesive with high melting point, high softening range of approx. 90°C, therefore also suitable for use on objects with a relatively high temperature resistance of -10°C to +75°C, chemical basis: Adhesive, resin, adhesive diameter 63 mm, adhesive height 26 mm, processing temperature 190°C, moisture resistance in accordance with D1, qty. in pack 48 piece(s), in carton	499813
EVA adhesive, brown EVA brn 48x-KA 65	for KA 65, Unfilled EVA adhesive – perfect join quality on brown decor, EVA universal adhesive with high melting point, high softening range of approx. 90°C, therefore also suitable for use on objects with a relatively high temperature resistance of -10°C to +75°C, chemical basis: Adhesive, resin, adhesive diameter 63 mm, adhesive height 26 mm, processing temperature 190°C, moisture resistance in accordance with D1, qty. in pack 48 piece(s), in carton	200059
EVA adhesive, black EVA blk 48x-KA 65	for KA 65, Unfilled EVA adhesive – perfect join quality on black decor, EVA universal adhesive with high melting point, high softening range of approx. 90°C, therefore also suitable for use on objects with a relatively high temperature resistance of -10°C to +75°C, chemical basis: Adhesive, resin, adhesive diameter 63 mm, adhesive height 26 mm, processing temperature 190°C, moisture resistance in accordance with D1, qty. in pack 48 piece(s), in carton	200060
12 PU adhesive, natural PU nat 4x-KA 65	for KA 65, caution: use rinsing agent to clean machine after use (PU spm 4x KA65, number 200062), can be stored for a maximum of 12 months, adhesive has high initial strength, and cold elasticity, and good solvent resistance, natural colour tone, PU adhesive packed in 200 g airtight containers, chemical basis: Polyurethane adhesive, caution! The polyurethane adhesive provided here contains “o-(p-isocyanatobenzyl)phenyl isocyanate; diphenylmethane-2,4'-diisocyanate” and as a result is labelled with the R40 phrase “Limited evidence of a carcinogenic effect”. We are obligated by the Chemikalien-Verbotsverordnung (German Chemicals Prohibition Ordinance) to draw your attention to the presence of hazardous substances in our polyurethane adhesive no. 200056. By purchasing said polyurethane adhesive, you are confirming that you are at least 18 years old, that you shall use the PU adhesive properly and protect skin, eyes and mucous membranes from direct contact with it, e.g. by wearing protective goggles, respiratory protection/mask and disposable gloves. We are trained and assessed in accordance with Section 5 of the Chemicals Prohibition Ordinance, adhesive diameter 63 mm, adhesive height 42 mm, processing temperature 140°C, temperature resistance -40°C – + 140° C, softening range 90°C, moisture resistance in accordance with D3/D4, weight 0,8 kg, qty. in pack 4 piece(s), in carton	200056
Rinsing agent PU spm 4x-KA 65	for KA 65, rinsing cartridge for the CONTURO KA 65 edge bander after use of PU adhesive, must be used after PU adhesive use to stop remaining PU adhesive chemically reacting, can be stored for a maximum of 12 months, packaged in 140 g containers, weight 0,56 kg, qty. in pack 4 piece(s), in carton	200062
13 Scraper ZK HW 45/45	trimming overhanging material after the edge is cut (plastic edging) without damaging the surface of the workpiece, smoothing away impact marks left by cutters during the routing process (R1, R1.5 and R2 mm curves), dimensions 45 x 45 mm, dimensions (L x W x H) 45 x 45 x 1,2 mm, curves 1/1,5/2 mm, in self-service display pack	499749
14 Edge trimming set KB-KA 65 SYS	for KA 65, protective edging, 20x StickFix Brilliant 2 80 x 133 P320 abrasive sheets, additional roll, trimming device, HSK 80 x 133 H sanding block, scraper, base runner scratch protector with 3x felt layers, Polishing felt, S 800 StickFix sanding cloth, MPA 5010 OR polish, in SYSTAINER SYS 4 T-LOC	500177



Stirring

Overview of products and applications	348
Stirrers MX 1000, MX 1000/2, MX 1200, MX 1200/2, MX 1600/2	351
DUO stirrers MX 1600/2 DUO	353
Accessories and consumable materials	354
The Festool system	

Stirring

Overview of products and applications

Page 351 ————— 351 ————— 351

Our stirrers focus on the most important requirements in your daily stirring and mixing applications: Sturdiness, durability, constant power under load and outstanding ergonomics.

MX 1000

MX 1000/2

MX 1200



Applications

Stirrers

Mixing and stirring

Liquid materials: paints, clear coats, wallpaper paste



Viscous materials: filling mixtures and smoothing cement



Stiff, compact materials: plaster, tile cement, mortar



Mixing volume

up to 40 l



up to 70 l

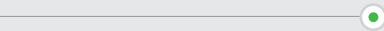

up to 90 l

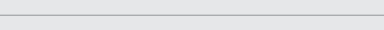

Technical data

Power consumption (W)	1.020	1.020	1.200
Idling speed, 1st gear (rpm)	360 – 630	360 – 630	360 – 630
Idling speed, 2nd gear (rpm)	–	580 – 1.010	–
Tool holder	M14/ErgoFix	M14/ErgoFix	M14/ErgoFix
Clamping collar diameter (mm)	57	57	57
Max. stirrer basket diameter (mm)	120	120	140
Weight (kg)	4,5	4,9	4,5

352 352 353

MX 1200/2

MX 1600/2

MX 1600/2 DUO



Stirrers

DUO stirrers



Extremely appropriate

Appropriate

	1.200	1.500	1.500
	150 – 360	150 – 300	100 – 250
	320 – 780	320 – 650	130 – 350
	M14/ErgoFix	M14/ErgoFix	FastFix
	57	57	57
	140	160	140
	6,2	6,4	7,9

Stirring

Maintains its position.

Stooped over mixing is now a thing of the past: The size of the MX stirrers can be adapted with the ErgoFix height adjustment. You work upright, protect your back and can completely rely on the powerful engines, which ensure intensive and quick mixing. For in between usage the stirrers have anti-slip rubber corners for positioning against the wall. And after the work is completed, they are easy to clean and transport – the machine and stirrer can be disconnected without the need for any tools.



Ergonomic – mix while standing upright.

Simply adjust the stirrer to match your height with the patented ErgoFix height adjustment system. Mix in a natural upright position for relaxed and effortless working.



One for all.

The ErgoFix adapter has a classic M14 tool holder so that all current stirrer baskets can be used. In addition, it is designed for the entire service life of the stirrer thanks to its special coating.



Lightning quick changes without using tools.

The FastFix quick-change system allows the detachment of the stirrer basket from the machine and rapid basket changes without the need for tools, easy cleaning and space-saving transportation.





MX 1000 / MX 1200

Robust, ergonomic, powerful.

- ▶ ErgoFix height adjustment with integrated quick-change function
- ▶ No material splash upon start-up thanks to soft start with variable speed trigger
- ▶ Less effort required for guiding the stirrer thanks to ergonomic handle design with large lever arm
- ▶ Powerful motor with power electronics for constant power development



Technical data	MX 1000	MX 1200
Power consumption [W]	1.020	1.200
Idling speed, 1st gear/2nd gear [min ⁻¹]	360 – 630/-	360 – 630/-
Tool holder	M14/ErgoFix	M14/ErgoFix
Collar dia. (mm)	57	57
Max. mixer container diameter (mm)	120	140
Mix quantity (l)	40	60
Weight (kg)	4,5	4,5



■ = MMC digital electronics

Items included	Order no.
ErgoFix adapter, double open-ended wrench, in carton	
MX 1000 E EF HS2 GB 240V stirrer rod HS 2 120x600 M14	574808
MX 1200 E EF HS2 GB 240V stirrer rod HS 2 140x600 M14	574809

Powerful.

Powerful motors combined with a perfectly adapted gear unit ensure a constant performance under load, can tackle even the most demanding mixing applications and withstand long periods of continuous use.

10

System accessories
from page 356



Stirring

Stirrers MX 1600/2



MX 1600/2



Extremely sturdy design.

The new stirrers can withstand the toughest of conditions, from heavy contamination to hard impacts or collisions, thanks to the drive with its long service life, the solid tubular steel frame, the switch guard and the rubber edges.

Extremely powerful for harsh industrial environments.

- ▶ For tough and heavy material with high torque, 2-gear transmission
- ▶ ErgoFix height adjustment with integrated quick-change function
- ▶ Less effort required for guiding the stirrer thanks to ergonomic handle design with large lever arm
- ▶ Powerful motor with power electronics for constant power development

Technical data

Power consumption (W)	1.500
Idling speed, 1st gear/2nd gear (min ⁻¹)	150 – 300/320 – 650
Tool holder	M14/ErgoFix
Collar dia. (mm)	57
Max. mixer container diameter (mm)	160
Mix quantity (l)	90
Weight (kg)	6,4



☐ = MMC digital electronics

Items included

ErgoFix adapter, double open-ended wrench, in carton

MX 1600/2 E EF HS3R GB
stirrer rod HS 3 160x600 R M14

Order no.

574810

System accessories from page 356



Stirring

Stirrer MX 1600/2 DUO



MX 1600/2 DUO



DUO stirrer: Quicker, easier, more intensive.

- ▶ Quicker at lower power thanks to mixing tools working in opposite direction
- ▶ Intensive and thorough mixing process with combing effect
- ▶ Quick change of stirring rod with FastFix system
- ▶ Electronic control and 2-gear manual transmission: The correct speed for every material

Technical data

Power consumption (W)	1.500
Idling speed, 1st gear/2nd gear (min ⁻¹)	100 – 250/130 – 350
Tool holder	FastFix
Collar dia. (mm)	57
Max. mixer container diameter (mm)	140
Spindle clearance (mm)	110
Mix quantity (l)	90
Weight (kg)	7,9



■ = MMC digital electronics

not available in Great Britain

Stationary application.

The DUO stirrer becomes the complete mixing station in the MS 57 stirrer stand. While you process the already mixed material, the next quantity is already being prepared in the stirrer stand.

System accessories
from page 359



The Festool system.

Because it's simply better when everything fits together: The right stirrer for every application. With the FastFix quick-change system, the stirrer basket can be changed easily and quickly for different materials.



Stirring

Accessories and consumable materials

System accessories

Stirring rods	356
Adapter	359
Mixing centre, stirrer	359



Stirring

Stirring rods

The ultimate solution for every mixing task.



RS	WS	HS3L	CS	HS2	HS3R
Round stirrer	Disc stirrer	Helical stirrer with 3 anticlockwise spirals	Whisk	Helical stirrer with 2 spirals	Helical stirrer with 3 clockwise spirals

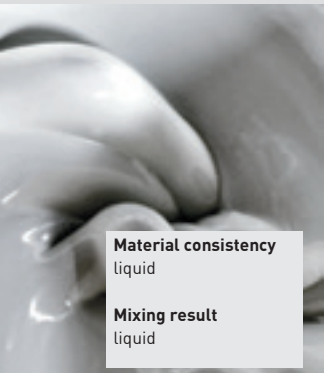

Material consistency

liquid

Mixing result

liquid

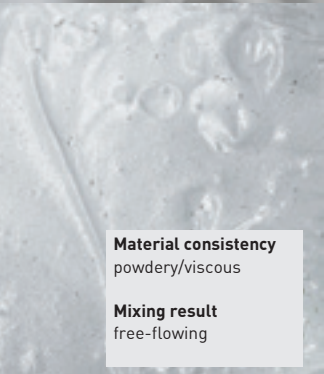

Material consistency

powdery/viscous

Mixing result

free-flowing



Material consistency

powdery/viscous

Mixing result

compact

	RS	WS	HS3L	CS	HS2	HS3R
Paints	<input checked="" type="radio"/>	<input checked="" type="radio"/>	<input checked="" type="radio"/>	<input type="radio"/>	<input type="radio"/>	<input type="radio"/>
Emulsion paint	<input type="radio"/>	<input checked="" type="radio"/>	<input checked="" type="radio"/>	<input type="radio"/>	<input type="radio"/>	<input type="radio"/>
Wallpaper paste	<input checked="" type="radio"/>	<input checked="" type="radio"/>	<input type="radio"/>	<input type="radio"/>	<input type="radio"/>	<input type="radio"/>
Clear coat, varnish	<input checked="" type="radio"/>	<input checked="" type="radio"/>	<input type="radio"/>	<input type="radio"/>	<input type="radio"/>	<input type="radio"/>
Epoxy resin	<input type="radio"/>	<input type="radio"/>	<input type="radio"/>	<input checked="" type="radio"/>	<input type="radio"/>	<input type="radio"/>
Filler	<input type="radio"/>	<input type="radio"/>	<input type="radio"/>	<input checked="" type="radio"/>	<input checked="" type="radio"/>	<input type="radio"/>
Bonding mortar	<input type="radio"/>	<input type="radio"/>	<input type="radio"/>	<input type="radio"/>	<input checked="" type="radio"/>	<input type="radio"/>
Levelling compound	<input type="radio"/>	<input type="radio"/>	<input type="radio"/>	<input checked="" type="radio"/>	<input type="radio"/>	<input type="radio"/>
Waterproofing filler	<input type="radio"/>	<input type="radio"/>	<input type="radio"/>	<input checked="" type="radio"/>	<input checked="" type="radio"/>	<input type="radio"/>
Bitumen	<input type="radio"/>	<input type="radio"/>	<input type="radio"/>	<input type="radio"/>	<input type="radio"/>	<input type="radio"/>
Ready-mix plaster	<input type="radio"/>	<input type="radio"/>	<input type="radio"/>	<input type="radio"/>	<input type="radio"/>	<input type="radio"/>
Plaster	<input type="radio"/>	<input type="radio"/>	<input type="radio"/>	<input type="radio"/>	<input checked="" type="radio"/>	<input checked="" type="radio"/>
Tile cement	<input type="radio"/>	<input type="radio"/>	<input type="radio"/>	<input type="radio"/>	<input checked="" type="radio"/>	<input type="radio"/>
Joint mortar	<input type="radio"/>	<input type="radio"/>	<input type="radio"/>	<input type="radio"/>	<input checked="" type="radio"/>	<input checked="" type="radio"/>
Mortar	<input type="radio"/>	<input type="radio"/>	<input type="radio"/>	<input type="radio"/>	<input checked="" type="radio"/>	<input checked="" type="radio"/>
Quartz-filled epoxy resin	<input type="radio"/>	<input type="radio"/>	<input type="radio"/>	<input type="radio"/>	<input type="radio"/>	<input checked="" type="radio"/>
Concrete, screed	<input type="radio"/>	<input type="radio"/>	<input type="radio"/>	<input type="radio"/>	<input type="radio"/>	<input checked="" type="radio"/>

Extremely appropriate Very appropriate

Stirring rods

Round stirrer



Round stirrer

for fluid materials, wall and emulsion paints, standard paste, sealing compounds, clear coats, bitumen, sludge, in self-service display pack

for chuck with clamping range ≥ 10 mm, material quantity – 15 kg, diameter 85 mm, length 400 mm

RS 2 85x400 SW 8

769023

for chuck with clamping range ≥ 13 mm, material quantity 15 – 25 kg, diameter 100 mm, length 600 mm

RS 2 100x600 SW 10

769024

for MX 1000, MX 1000/2, MXP 800, MXP 1000, MXP 1002, material quantity 15 – 25 kg, diameter 100 mm, length 600 mm

RS 2 100x600 M14

769020

for MX 1000, MX 1000/2, MXP 800, MXP 1000, MXP 1002, material quantity 20 – 40 kg, diameter 120 mm, length 600 mm

RS 2 120x600 M14

769021

Disk stirrer WS



Disc stirrer

for liquid materials, paints, varnishes, wall paint, emulsion paint, wallpaper paste, glue, tile cement, in self-service display pack

for chuck with clamping range ≥ 10 mm, material quantity – 5 kg, diameter 60 mm, length 350 mm

WS 2 60x350 SW 8

769033

for chuck with clamping range ≥ 10 mm, material quantity 5 – 10 kg, diameter 80 mm, length 350 mm

WS 2 80x350 SW 8

769034

for chuck with clamping range ≥ 13 mm, material quantity 10 – 15 kg, diameter 100 mm, length 600 mm

WS 2 100x600 SW 10

769035

Disk stirrer



Disc stirrer

for liquid materials, paints, varnishes, wall paint, emulsion paint, wallpaper paste, glue, tile cement, length 600 mm, in self-service display pack

for MX 1000, MX 1000/2, MXP 800, MXP 1000, MXP 1002, material quantity 15 – 20 kg, diameter 120 mm

WS 2 120x600 M14

768122

for MX 1200, MX 1200/2, MXP 1200, MXP 1202, material quantity 20 – 30 kg, diameter 140 mm

WS 2 140x600 M 14

769022

for MX 1600/2, MXP 1602, material quantity 30 – 60 kg, diameter 160 mm

WS 2 160x600 M 14

769036

Spiral stirrer



Spiral stirrer

3 anticlockwise spirals, for thin materials, gypsum plaster, emulsion paint, clear coats, wall paints, sealing compounds, length 600 mm, in self-service display pack

for MX 1000, MX 1000/2, MXP 800, MXP 1000, MXP 1002, material quantity 15 – 25 kg, diameter 120 mm

HS 3 120x600 L M14

767921

for MX 1200, MX 1200/2, MXP 1200, MXP 1202, material quantity 25 – 40 kg, diameter 140 mm

HS 3 140x600 L M14

768138

for MX 1600/2, MXP 1602, material quantity 30 – 60 kg, diameter 160 mm

HS 3 160x600 L M14

768709

Stirring

System accessories

Stirring rods

Stirrer CS



Stirrer

for filling mixtures and smoothing cement, sealant, adhesives, for stirring without trapping air (no air bubbles), length 600 mm, in self-service display pack

	Type	Order no.
for chuck with clamping range ≥ 13 mm, material quantity 10 – 25 kg, diameter 120 mm	CS 120x600 SW10 not available in Great Britain	769119
for MX 1000, MX 1000/2, MXP 800, MXP 1000, MXP 1002, material quantity 10 – 15 kg, diameter 120 mm	CS 120x600 M14 not available in Great Britain	769118
for MX 1200, MX 1200/2, MXP 1200, MXP 1202, material quantity 20 – 40 kg, diameter 140 mm	CS 140x600 M14	769117
for MX 1600/2, MXP 1602, material quantity 40 – 60 kg, diameter 160 mm	CS 160x600 M14 not available in Great Britain	769116

Spiral stirrer HS 2



Spiral stirrer

for chuck with clamping range ≥ 10 mm, 2 spirals, for viscous materials, tile cement, filling compounds, flooring mixtures, ready-mix plasters, screed, smoothing cement, filling mixtures, length 400 mm, in self-service display pack

	Type	Order no.
material quantity – 8 kg, diameter 70 mm	HS 2 70x400 SW 8 not available in Great Britain	769025
material quantity 8 – 10 kg, diameter 85 mm	HS 2 85x400 SW 8 not available in Great Britain	769026

Spiral stirrer



Spiral stirrer

2 spirals, for viscous materials, tile cement, filling compounds, flooring mixtures, ready-mix plasters, screed, smoothing cement, filling mixtures, in self-service display pack

	Type	Order no.
for chuck with clamping range ≥ 10 mm, material quantity 10 – 15 kg, diameter 100 mm, length 400 mm	HS 2 100x400 SW 8 not available in Great Britain	769027
for chuck with clamping range ≥ 13 mm, material quantity 15 – 20 kg, diameter 120 mm, length 600 mm	HS 2 120x600 SW 10 not available in Great Britain	769028
for chuck with clamping range ≥ 13 mm, material quantity 20 – 40 kg, diameter 140 mm, length 600 mm	HS 2 140x600 SW 12 not available in Great Britain	769029
for MX 1000, MX 1000/2, MXP 800, MXP 1000, MXP 1002, material quantity 15 – 20 kg, diameter 120 mm, length 600 mm	HS 2 120x600 M14	769030
for MX 1200, MX 1200/2, MXP 1200, MXP 1202, material quantity 20 – 40 kg, diameter 140 mm, length 600 mm	HS 2 140x600 M14	769031
for MX 1600/2, MXP 1602, material quantity 30 – 60 kg, diameter 160 mm, length 600 mm	HS 2 160x600 M14 not available in Great Britain	769032

HS 3 R helical stirrer with ring





Spiral stirrer

3 clockwise spirals, for stiff materials with a high viscosity, mortar, concrete, cement and lime plaster, mounting binder, screed, quartz-filled epoxy resin, bitumen, thick coatings, length 600 mm, in self-service display pack

	Type	Order no.
for MX 1000, MX 1000/2, MXP 800, MXP 1000, MXP 1002, material quantity 15 – 25 kg, diameter 120 mm	HS 3 120x600 R M14 not available in Great Britain	767887
for MX 1200, MX 1200/2, MXP 1200, MXP 1202, material quantity 25 – 40 kg, diameter 140 mm	HS 3 140x600 R M14 not available in Great Britain	768708
for MX 1600/2, MXP 1602, material quantity 30 – 60 kg, diameter 160 mm	HS 3 160x600 R M14	768710



Stirring rods for MX 1600/2 EQ DUO

		Type	Order no.
	Stirring rod for MX 1600/2 DUO, MXP 1602 DUO, for liquid and viscous materials, lower part of the stirrer cage raises mixture from the bottom of the container upwards. Upper part of the stirrer cage pushes mixture downwards, diameter 140 mm, length 600 mm, in carton	HS 3 COMBI 140x600 FF	768092
	Stirring rod for MX 1600/2 DUO, MXP 1602 DUO, For high viscosity or heavy materials needing thorough mixing, two stirrer rods, each with three helices, counter-rotate. Mixture is pulverised and whisked, diameter 140 mm, length 600 mm, in carton	HS 3 DOUBLE 140x600 FF	768800



ErgoFix adapter

		Type	Order no.
	Adapter with M14 thread, For holding Festool stirrer rods M14 at ErgoFix stirrers, stroke length 80 mm, in self-service display pack	AD-EF-M14/80 ErgoFix	769091

Adapters and extensions

		Type	Order no.
	in self-service display pack Adapter fitting stirrer rods with internal thread	MA M14-M14	769148
	Adapter Clamping drill chuck 5/8" to stirrer	MA M14-5/8" x 16	not available in Great Britain 769149
	Adapter fitting 1/2" chucks to stirrers	MA M14-1/2" x 20	not available in Great Britain 769150
	Adapter fitting Festool stirring rods with external thread to stirrers (RW 1000)	MAI M14-M14	769151
	Adapter for drills with 5/8" holder – 16 UNF, fitting Festool stirring rods to drills	MAI M14-5/8" x 16	not available in Great Britain 769153
	Adapter for drills with 1/2" holder – 20 UNF, fitting Festool stirring rods to drills	MAI M14-1/2" x 20	not available in Great Britain 769152
	Guide extension for extending all stirrer rods by 400 mm, thread M14, M14 thread on both ends	PL 400 M14/M14	not available in Great Britain 769037

Mixing centre, stirrer

		Type	Order no.
	Stirrer stand excellent stability and reliability due to the robust zinc-coated steel construction, the stand can be simply disassembled for easy transport, stirrer stand with safety switch, 4 m power cord, clamp for attachment collar 57 mm, length x width 950 x 550 mm, height adjustable 1.000 – 1.520 mm, max. dia. mixture container 400 mm, weight 30 kg, in carton	MS 57	not available in Great Britain 769039
	Fixed rod for attaching mixing containers to the stirrer stand MS 57, suitable for container heights between 300 mm and 500 mm, in carton	CL-MS	not available in Great Britain 769048
	Adapter ring for holding stirrers with a collar dia. 43 mm in MS 57, in self-service display pack	A-GD 57/43	not available in Great Britain 768712



Preparing the substrate

Overview of products and applications	362
Diamond grinders RENOFIX RG 130	367
Diamond grinding system DSG-AG 125	368
RENOFIX renovation millers RG 80, RG 150	369
Diamond cutting system DSC-AG 125, DSC-AG 125 FH, DSC-AG 230	371
Carpet remover TPE	374
Wallpaper perforator TP 220	375
Accessories and consumable materials	376
The Festool system	

Preparing the substrate

Overview of products and applications

Concrete, stone, plaster, adhesive, paint and other old coatings can often only be removed with great effort. That's why there is the RENOFIX renovation millers, with which you can easily master all challenges in material removal capacity.

Page

367

368

RG 130



DSG-AG 125



Diamond grinders RENOFIX

Diamond grinding system



DIA STONE
DIA HARD
DIA ABRASIVE
DIA THERMO
DIA UNI

DIA STONE
DIA HARD
DIA ABRASIVE
DIA THERMO
DIA UNI

Applications

Plaster

- Milling off mineral/soft plaster on walls and façades
- Milling off hard (cement) plaster on walls and façades
- Milling off synthetic resin plaster

Adhesive

- Removing tile adhesive/adhesive residue
- Removing elasticised adhesive for PVC or wooden flooring

Concrete

- Grinding unset concrete area/parts
- Light grinding of weathered and cured concrete areas
- Roughing up smooth surfaces on concrete
- Grinding very hard concrete (C30/37 and harder)
- Sanding off for levelling unevenness on cured concrete

Colour

- Removing latex paints, oil-based paints and paint coatings on plaster
- Removing concrete paint on concrete surfaces
- Removing elasticised protective coating

Coatings

- Removing bitumen
- Removing PU coatings
- Levelling unevenness on screed flooring
- Removing epoxy resin coatings
- Removing impaired fillers

Others

- Light sanding/Roughing of Terazzo/tiles

Technical data

Power consumption (W)	1.600	1.400
Idle engine speed (rpm)	3.000 – 7.700	3.500 – 11.000
Disc Ø (mm)		125/130
Tool diameter (mm)	130	
Connection Ø d/e (mm)	36	36/27
Tool holder	D25/M14	
Weight (kg)	3,8	2,7

Preparing the substrate

Overview of products and applications

369 ————— 370

RG 80

RG 150



Renovation miller RENOFIX

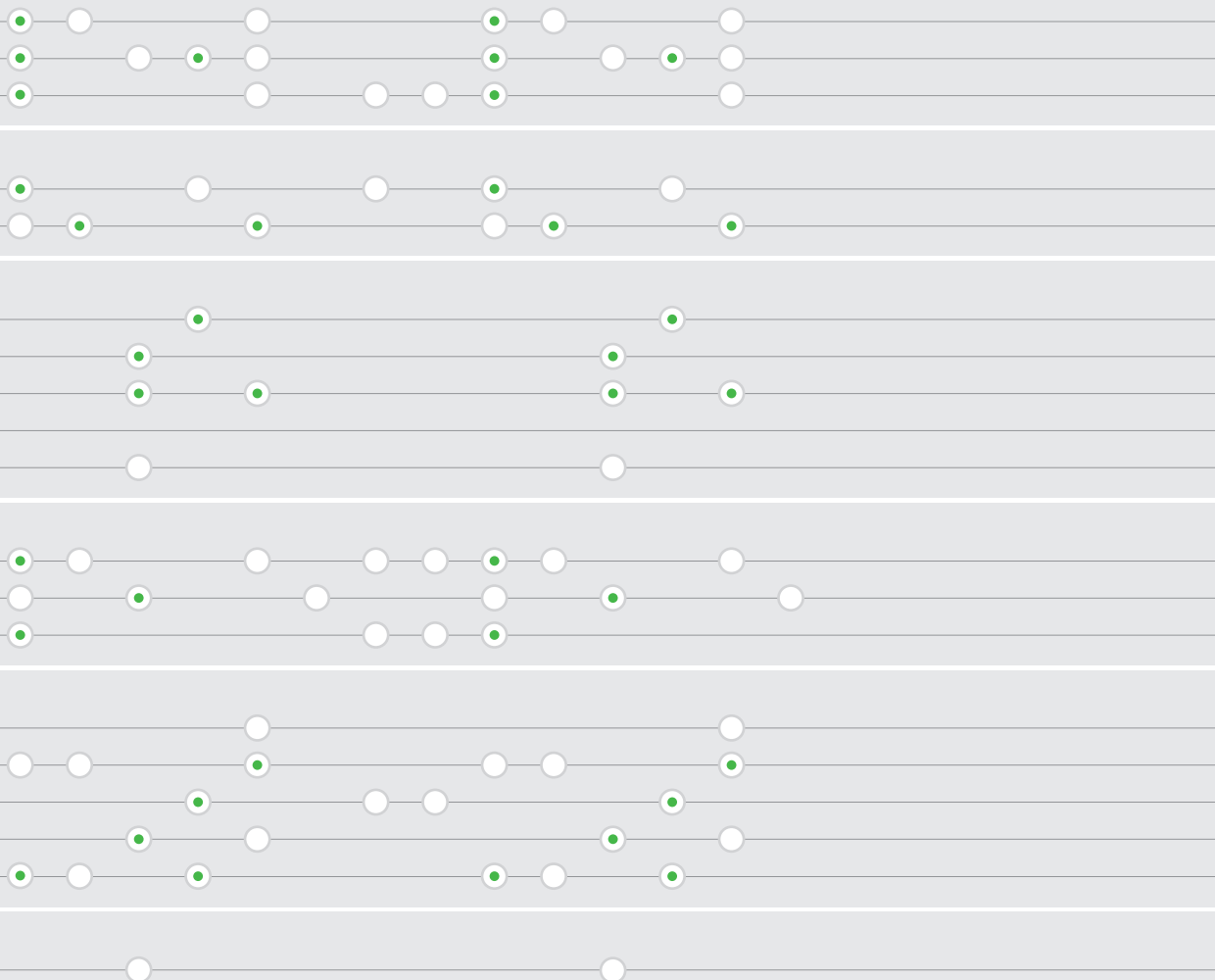
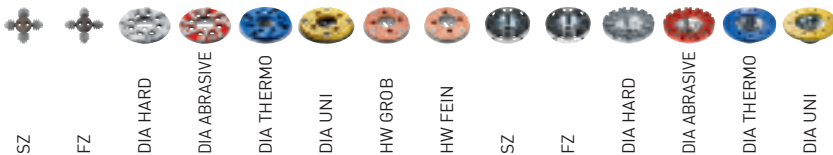

Suitable for areas in size shown, by comparison Extremely appropriate Appropriate

1.100	1.600
2.000 – 5.900	1.000 – 2.200
80	150
36	36
2 x M5	D14/M8
3,2	5,5

Preparing the substrate

Overview of products and applications

Page 371 ————— 372 ————— 373

Indoors or outdoors: The Festool diamond cutting system constantly works dust-free. With the extractor system from Festool you avoid timely cleaning of the construction site.

DSC-AG 125

DSC-AG 125 FH

DSC-AG 230



Applications

Diamond cutting system

Cutting panels to size

Cutting tiles	<input checked="" type="radio"/>	<input checked="" type="radio"/>	<input type="radio"/>
Cutting plasterboard/cement-bonded fibreboard	<input type="radio"/>	<input type="radio"/>	<input type="radio"/>
Cutting HPL sheets	<input type="radio"/>	<input type="radio"/>	<input type="radio"/>
Cutting natural stone	<input type="radio"/>	<input type="radio"/>	<input checked="" type="radio"/>

Cutting roof tiles

Cutting roof tiles	<input type="radio"/>	<input checked="" type="radio"/>	<input type="radio"/>
--------------------	-----------------------	----------------------------------	-----------------------

Cutting expansion joints

Cutting expansion joints	<input checked="" type="radio"/>	<input checked="" type="radio"/>	<input checked="" type="radio"/>
--------------------------	----------------------------------	----------------------------------	----------------------------------

Cutting open cracks in screed

Cutting open cracks in screed	<input checked="" type="radio"/>	<input checked="" type="radio"/>	<input checked="" type="radio"/>
-------------------------------	----------------------------------	----------------------------------	----------------------------------

Cutting screed/concrete

Cutting screed/concrete	<input checked="" type="radio"/>	<input type="radio"/>	<input checked="" type="radio"/>
-------------------------	----------------------------------	-----------------------	----------------------------------

Cutting finished concrete parts

Cutting finished concrete parts	<input type="radio"/>	<input type="radio"/>	<input checked="" type="radio"/>
---------------------------------	-----------------------	-----------------------	----------------------------------

Cutting grooves

Grooves for electrical installations	<input type="radio"/>	<input type="radio"/>	<input type="radio"/>
--------------------------------------	-----------------------	-----------------------	-----------------------

Extremely appropriate Appropriate

Technical data

	DSC-AG 125	DSC-AG 125 FH	DSC-AG 230
Power consumption (W)	1.400	1.400	2.600
Idle engine speed (rpm)	3.500 – 11.000	3.500 – 11.000	6.500
Disc Ø (mm)	125	125	230
Connection Ø d/e (mm)	36/27	36/27	36/27
Weight (kg)	4,1	2,9	8,9

Removing carpet or wallpaper, sanding plasterboard – materials and requirements in the area of refurbishment, drywalling and renovation are diverse. Festool offers a wide range of solutions, incorporated in a complete system of accessories and consumables.

TPE

TP 220



Applications

Carpet remover

Wallpaper perforator

Renovation and refurbishment

Removing wallpaper

Carpet removal

Removing backing and adhesive layers



Extremely appropriate

Appropriate

Technical data

Power consumption (W)	620	
Idle engine speed (rpm)	6.000	
rpm	12.000	
Sanding stroke (mm)	5	
Weight (kg)	3,6	1,5

Preparing the substrate

When renovating, you will be facing tough opponents.

Concrete, stone, plaster, adhesive, paint and other old coatings are often very difficult to remove. With manual work or conventional machines such as hammer drills, chisels or angle grinders, you do not stand a chance. This is what Festool RENOFIX tools are for. On exteriors and walls, floors and ceilings, the RENOFIX diamond sanders and renovation millers quickly and thoroughly remove all kinds of old coatings.



Comfortable handling.

The additional handle with vibration damping significantly reduces the vibrations and therefore protects the hands of the user, guaranteeing low-fatigue work. The position of the additional handle can be adjusted quickly to the different work conditions without using any tools. The handle can even be folded away completely, making it possible to reach under heating pipes. The guide table ensures that the diamond cutter is guided cleanly onto the surfaces to be worked, and also enables a specific material removal capacity to be set.



Right up to the edges.

The segment can be folded back without using tools, enabling work to be carried out close to the edges. A wall stop and diamond wheel (recessed by 0.5 mm) prevent any possibility of damage to the wall and edges.



Preparing the substrate

Diamond grinder RENOFIX RG 130



RENOFIX RG 130

The specialist for hard sub-surfaces.

- ▶ Diamond grinder operates at the perfect speed for diamond tools
- ▶ 1,600 W motor for rapid material removal and working progress
- ▶ Folding segment allows you to work directly on walls
- ▶ Reliable guidance and adjustable, defined material removal with guide table

Technical data

Power consumption (W)	1.600
Idle engine speed (min ⁻¹)	3.000 – 7.700
Tool dia. (mm)	130
Tool holder	D25/M14
Dust extraction connection dia. (mm)	36
Weight (kg)	3,8



■ = Electronic

Items included

RG 130 E-Plus GB 240V
front handle, flange set, Spanner, in SYSTAINER SYS 5 T-LOC

Order no.

574800



Powerful, fast and dust-free.

The RG 130 diamond sander meets all requirements. The speed optimised for diamond tools enables quick removal of concrete, screed and coatings on hard substrates. The segment which can be folded down without any tools makes it possible to work right up to the edge. Thanks to the patented extraction spiral, excellent dust extraction results are guaranteed.

11

System accessories
from page 378



Preparing the substrate

Diamond grinding system DSG-AG 125

DSG-AG 125



Lightweight and compact.

With the grinding system Festool provides a compact system for virtually dust-free grinding. Unevenness can be levelled, paints, concrete, adhesive and plaster can be removed and surfaces prepared for new coatings. The folding front segment enables working right into edges and corners.



The convenient sanding system for small areas.

- ▶ FastFix system for quick and easy removal and attachment of the guard
- ▶ Sliding segment for working close to edges
- ▶ Brush ring for efficient dust extraction
- ▶ With speed control for adapting to the working material

Technical data

Power consumption (W)	1.400
Idle engine speed (min ⁻¹)	3.500 – 11.000
Disc dia. (mm)	125/130
Dust extraction connection dia. (mm)	36/27
Weight of cover/system (kg)	0,4/2,7



= MMC Multi Material Control electronics

Items included

DSG-AG 125 Plus GB 240V
extraction hood, in SYSTAINER SYS 3 T-LOC

Order no.

574804

System accessories from page 379



Preparing the substrate

Renovation miller RENOFIX RG 80



RENOFIX RG 80



The universal machine for walls, ceilings and floors.

- ▶ Universal renovation miller operates at the perfect speed for machining soft materials, option of using DIA tools
- ▶ Compact, flexible and powerful machine with 1,100 W motor
- ▶ Constant speed under load due to MMC Electronic
- ▶ Dust extraction – clean work place

Technical data

Power consumption (W)	1.100
Idle engine speed (min ⁻¹)	2.000 – 5.900
Tool dia. (mm)	80
Tool holder	2 x M5
Dust extraction connection dia. (mm)	36
Weight (kg)	3,2



■ = Electronic

not available in Great Britain

One for all.

The RG 80 renovation miller is a multitasking tool for medium-sized and larger areas. Thanks to the wide range of accessories, you can effortlessly remove hard and soft materials. Adhesives, paint and coatings, synthetic resin plaster, porous concrete and sand-lime brick on flooring, walls and ceilings can be removed easily and quickly.

11

System accessories
from page 380

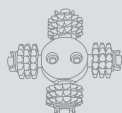

Preparing the substrate

Renovation miller RENOFIX RG 150



RENOFIX RG 150



The right tool for every material.

The RG 150 renovation miller is your perfect partner for large areas thanks to the 150 mm tool diameter and a wide range of accessories. In conjunction with the floor guide, screed, coatings and adhesive residue can be removed conveniently. The ergonomic D-shaped double handle sits perfectly in your hands in every work position.

The all-rounder for larger areas.

- ▶ Renovation miller operates at the perfect speed for machining soft materials over large surface areas
- ▶ Robust and powerful 1,600 W motor
- ▶ "D" handles for safe, comfortable handling
- ▶ Efficient dust extraction and automatic seal with guard

Technical data

Power consumption (W)	1.600
Idle engine speed (min ⁻¹)	1.000 – 2.200
Tool dia. (mm)	150
Tool holder	D14/M8
Dust extraction connection dia. (mm)	36
Weight (kg)	5,5



= Electronic

not available in Great Britain

System accessories
from page 381



Preparing the substrate

Diamond cutting system DSC-AG 125



DSC-AG 125

Precise cutting without dust.

- ▶ Cutting system with efficient dust extraction, protects health
- ▶ Suitable for use with Festool guide rail for precision cutting
- ▶ Guide table with easy-running rollers for accurate guidance along the workpiece
- ▶ Vision panel provides a clear view of the cutting line

Technical data

Power consumption [W]	1.400
Idle engine speed [min ⁻¹]	3.500 – 11.000
Disc dia. [mm]	125
Side clearance [mm]	32
Front clearance [mm]	78
Cutting depth without/with guide rail [mm]	27/23
Dust extraction connection dia. [mm]	36/27
Weight of cover/system [kg]	2,2/4,1



■ = MMC Multi Material Control electronics

Items included	Order no.
extraction hood DCC-AG 125, diamond disc ALL-D125 Premium, in SYSTAINER SYS 4 T-LOC	
DSC-AG 125 Plus GB 240V	574807
DSC-AG 125 Plus-FS GB guide rail FS 800/2	574805

System accessories from page 382

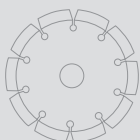

Dust-free work.

The diamond cutting system DSC-AG 125 with its efficient dust extraction protects your health when working. In combination with the Festool guide rail precise cuts can be made at doors, windows, grooves and expansion joints in the floor area.

Preparing the substrate

Diamond cutting system DSC-AG 125 FH



DSC-AG 125 FH



Dust-free cutting work.

The freehand cutting system with a cutting depth up to 27 mm. For dust-free, precise cutting of mineral panels such as tiles and natural stone. Ideal for laying tiles, correcting damage to walls and floors, repairing cracks or cutting expansion joints.

As flexible as an angle grinder: But without dust.

- ▶ High suction power for dust-free cutting
- ▶ Excellent view of the cutting point for precise, free cuts
- ▶ Enables proximate work by opening the cover
- ▶ Speed control for adapting to the working material

Technical data

Power consumption (W)	1.400
Idle engine speed (min ⁻¹)	3.500 – 11.000
Disc dia. (mm)	125
Side clearance (mm)	23
Front clearance (mm)	16
Cutting depth without/with guide rail (mm)	27/-
Dust extraction connection dia. (mm)	36/27
Weight of cover/system (kg)	0,6/2,9



■ = MMC Multi Material Control electronics

Items included

DSC-AG 125 FH-Plus GB 240V
extraction hood DCC-AG 125 FH, diamond disc ALL-D125 Standard,
plate TP-DSC-AG 125 FH, Auxiliary handle VIBRASTOP,
in SYSTAINER SYS 3 T-LOC

Order no.

574806

System accessories from page 382

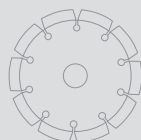

Preparing the substrate

Diamond cutting system DSC-AG 230



DSC-AG 230



Cuts powerfully through mineral construction materials up to 63 mm thick.

- ▶ Cutting system with efficient dust extraction, protects health
- ▶ Suitable for use with Festool guide rail for precision cutting
- ▶ Guide table with easy-running rollers for accurate guidance along the workpiece
- ▶ sealing lip for perfect dust extraction when used with the guide rail

Technical data

Power consumption (W)	2.600
Idle engine speed (min ⁻¹)	6.500
Disc dia. (mm)	230
Side clearance (mm)	35
Front clearance (mm)	85
Cutting depth without/with guide rail (mm)	63/59
Dust extraction connection dia. (mm)	36/27
Weight of cover/system (kg)	3,2/8,9



not available in Great Britain

Precise and efficient cutting – without dust.

Dusty atmospheres during cutting work are now a thing of the past. The hazardous dust is now extracted reliably, the health of the user protected and a free view of the workpiece guaranteed. Together with compatible accessories and consumables, the perfect solution for efficient, clean and precise work is created.

System accessories
from page 382

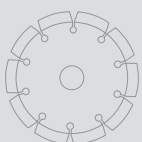

Preparing the substrate

Carpet remover TPE-RS 100

TPE



Wear-resistant blade.

The carpet blade moves back and forth, doing all the hard work for you. Always reliable, easy to sharpen. It quickly works its way in between the sublayer and the adhesive layer. All you have to do is push forwards slightly. Saving time has never been easier.



Quick and easy.

- ▶ Hand-held use for awkward spots and stairs
- ▶ Extension handle for non-tiring work over large areas
- ▶ Powerful stirring action and reduction gearing for maximum economic efficiency
- ▶ High area capacity: 25 m² per hour on compact foam-backed carpets

Technical data

Power consumption (W)	620
Idle engine speed (min ⁻¹)	6.000
No. of strokes (min ⁻¹)	12.000
Stroke (mm)	5
Blade width (mm)	195
Weight (kg)	3,6



not available in Great Britain

System accessories
from page 383

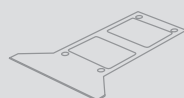

Preparing the substrate

Wallpaper perforator TP 220



TP 220

Attacks the wallpaper. Then removes it.

- ▶ Little effort is required because of the completely new working principle
- ▶ The adjustable penetration depth of the rollers protects the subsurface from being damaged
- ▶ The adjustable telescoping handle is perfect for working in rooms with high walls and on ceilings
- ▶ Protective cover for safe and clean transport

Technical data

Telescoping handle length (m)	0,9 – 1,3
Max. depth adjustment (mm)	3,5
Cutting diameter (mm)	45
Dimensions (L x W x H) (mm)	168 x 224 x 52
Weight (kg)	1,5

Items included

TP 220
protective cover, telescoping handle, in carton

Order no.

495747



Completely new working principle.

The TP 220 is our professional tool for removing wallpaper. Rollers rotating at different speeds create funnel-shaped openings so that water can optimally flow in behind the wallpaper and then seep into the wallpaper – all without damaging the coat underneath.

11

System accessories from page 383



The Festool system.

Because things work better when everything fits together: The comprehensive system accessories for refurbishment and renovation provide the appropriate and dust-free solution for removing concrete, stone, plaster, adhesive, paint, carpet and wallpaper. Festool has the appropriate solution in its product range, starting with the correct tool heads for processing a wide variety of materials with RENOFIX tools through to the exemplary mobile dust extractors for renovation millers.



Preparing the substrate

Accessories and consumable materials

System accessories

378



Preparing the substrate

System accessories

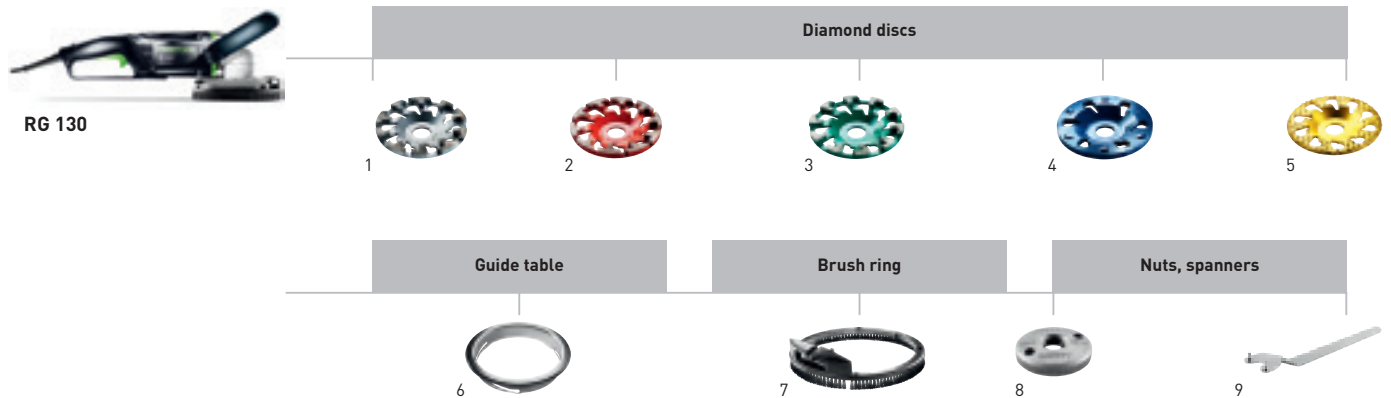

Accessories for diamond grinder RENOFIX RG 130

Denomination	Explanation	Order no.
1 Diamond disc DIA HARD-D130 PREMIUM	for RG 130, AG 125, RGP 130, AGP 125, for old solid concrete, removal of epoxy resin from solid surfaces or coatings/paints from concrete, diameter 130 mm, interior dia. 25/22,2 mm, active surface 3.000 mm ² , segment height 7 mm, in self-service display pack	768017
Diamond disc DIA HARD-D130-ST	for RG 130, AG 125, RGP 130, AGP 125, for old solid concrete, removal of epoxy resin from solid surfaces or coatings/paints from concrete, diameter 130 mm, interior dia. 25/22,2 mm, active surface 2.300 mm ² , segment height 5 mm, in carton	499972
2 Diamond disc DIA ABRASIVE-D130 PREMIUM	for RG 130, AG 125, RGP 130, AGP 125, for sand-based materials, screed, fresh concrete, adhesive on screed, sand-lime brick and cellular concrete, diameter 130 mm, interior dia. 25/22,2 mm, active surface 3.460 mm ² , segment height 7 mm, in self-service display pack	768018
Diamond disc DIA ABRASIVE-D130-ST	for RG 130, AG 125, RGP 130, AGP 125, for sand-based materials, screed, fresh concrete, adhesive on screed, sand-lime brick and cellular concrete, diameter 130 mm, interior dia. 25/22,2 mm, active surface 2.300 mm ² , segment height 5 mm, in carton	499973
3 Diamond disc DIA STONE-D130 PREMIUM	for RG 130, AG 125, RGP 130, AGP 125, for extremely hard materials and hard concrete (harder than B 35), diameter 130 mm, interior dia. 25/22,2 mm, in self-service display pack	769166
4 Diamond disc DIA THERMO-D130 PREMIUM	for RG 130, AG 125, RGP 130, AGP 125, for removing thermoelastic materials, diameter 130 mm, interior dia. 25/22,2 mm, in self-service display pack	768023
5 Diamond disc DIA UNI-D130 PREMIUM	for RG 130, AG 125, RGP 130, AGP 125, for paint and adhesive on wooden flooring, diameter 130 mm, interior dia. 25/22,2 mm, in self-service display pack	769167
6 Guide table GT-RG 130	for RG 130, RGP 130, Enables the material removal capacity rate to be adjusted and thus the removal in defined layers, in self-service display pack	769080
7 Brush ring BC-RG 130	for RG 130, RGP 130, replaceable spare brush rim, in self-service display pack	769110
8 Clamping nut UF-DSC/DSG-AG M14	for DSC-AG 125/230, DSG-AG 125 and RG 130, for disc Ø 115-230 mm, Front clamping flange, for clamping the grinding disc, from BJ 03/2015, holder M14, in self-service display pack	200241
9 Key KF-AG	for DSC-AG 125/230, for flange, in bag	769040

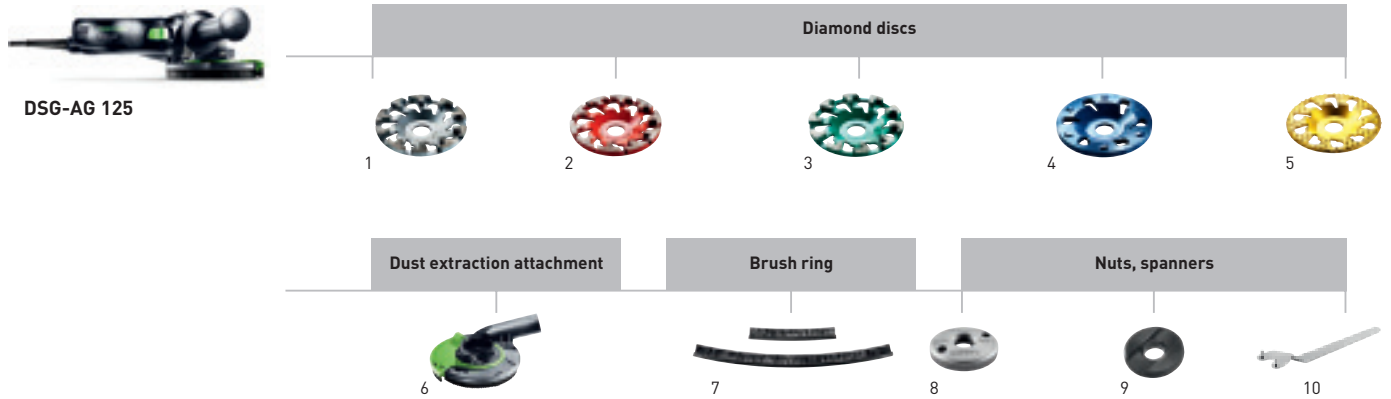

Accessories for Diamant grinding system DSG-AG 125

Denomination	Explanation	Order no.
1 Diamond disc DIA HARD-D130 PREMIUM	for RG 130, AG 125, RGP 130, AGP 125, for old solid concrete, removal of epoxy resin from solid surfaces or coatings/paints from concrete, diameter 130 mm, interior dia. 25/22,2 mm, active surface 3.000 mm ² , segment height 7 mm, in self-service display pack	768017
2 Diamond disc DIA ABRASIVE-D130 PREMIUM	for RG 130, AG 125, RGP 130, AGP 125, for sand-based materials, screed, fresh concrete, adhesive on screed, sand-lime brick and cellular concrete, diameter 130 mm, interior dia. 25/22,2 mm, active surface 3.460 mm ² , segment height 7 mm, in self-service display pack	768018
3 Diamond disc DIA STONE-D130 PREMIUM	for RG 130, AG 125, RGP 130, AGP 125, for extremely hard materials and hard concrete (harder than B 35), diameter 130 mm, interior dia. 25/22,2 mm, in self-service display pack	769166
4 Diamond disc DIA THERMO-D130 PREMIUM	for RG 130, AG 125, RGP 130, AGP 125, for removing thermoelastic materials, diameter 130 mm, interior dia. 25/22,2 mm, in self-service display pack	768023
5 Diamond disc DIA UNI-D130 PREMIUM	for RG 130, AG 125, RGP 130, AGP 125, for paint and adhesive on wooden flooring, diameter 130 mm, interior dia. 25/22,2 mm, in self-service display pack	769167
6 Dust extraction attachment DCG-AG 125	for AG 125, AGP 125-12/14, Clamping flange, disc dia. 125/130 mm, weight 0,4 kg, dust extraction connection dia. 36/27 mm, in self-service display pack	769076
7 Brush ring BC-DCG AG 125	for DCG-AGP 125, in self-service display pack	769081
8 Clamping nut UF-AG M14	for DSC-AG 125/230, DSG-AG 125 and RG 130, for disc Ø 115-230 mm, Front clamping flange, for clamping the grinding disc, up to BJ 02/2015, holder M14, in self-service display pack	769018
Clamping nut UF-DSC/DSG-AG M14	for DSC-AG 125/230, DSG-AG 125 and RG 130, for disc Ø 115-230 mm, Front clamping flange, for clamping the grinding disc, from BJ 03/2015, holder M14, in self-service display pack	200241
9 Flange BF-AG 22,2	for DSC-AG 125/230, for disc Ø 115-230 mm, Rear clamping flange, for clamping the grinding disc, holder 22,2 mm, in self-service display pack	767973
10 Key KF-AG	for DSC-AG 125/230, for flange, in bag	769040

Preparing the substrate

System accessories



RG 80

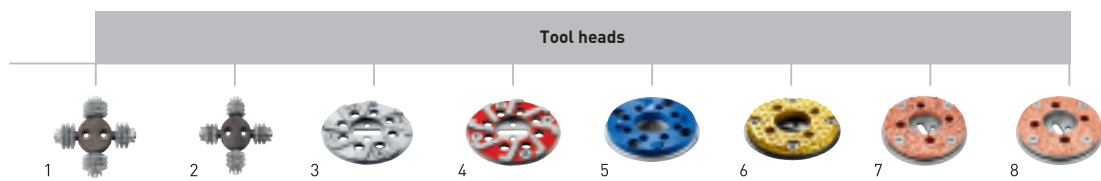

Accessories for renovation miller RG 80 E

not available in Great Britain

Preparing the substrate

System accessories



RG 150

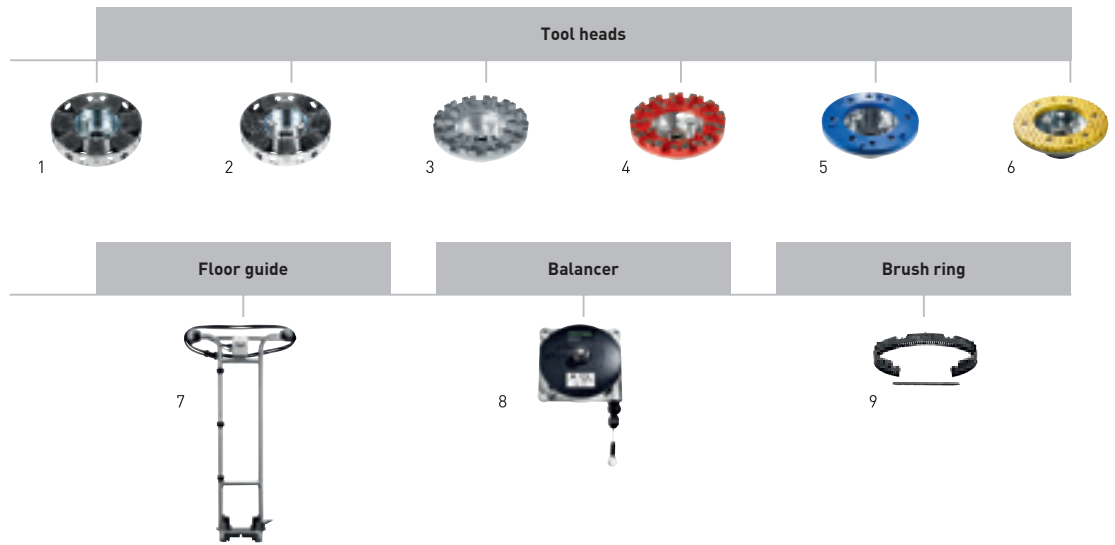

Accessories for renovation miller RG 150 E

not available in Great Britain

Preparing the substrate

System accessories

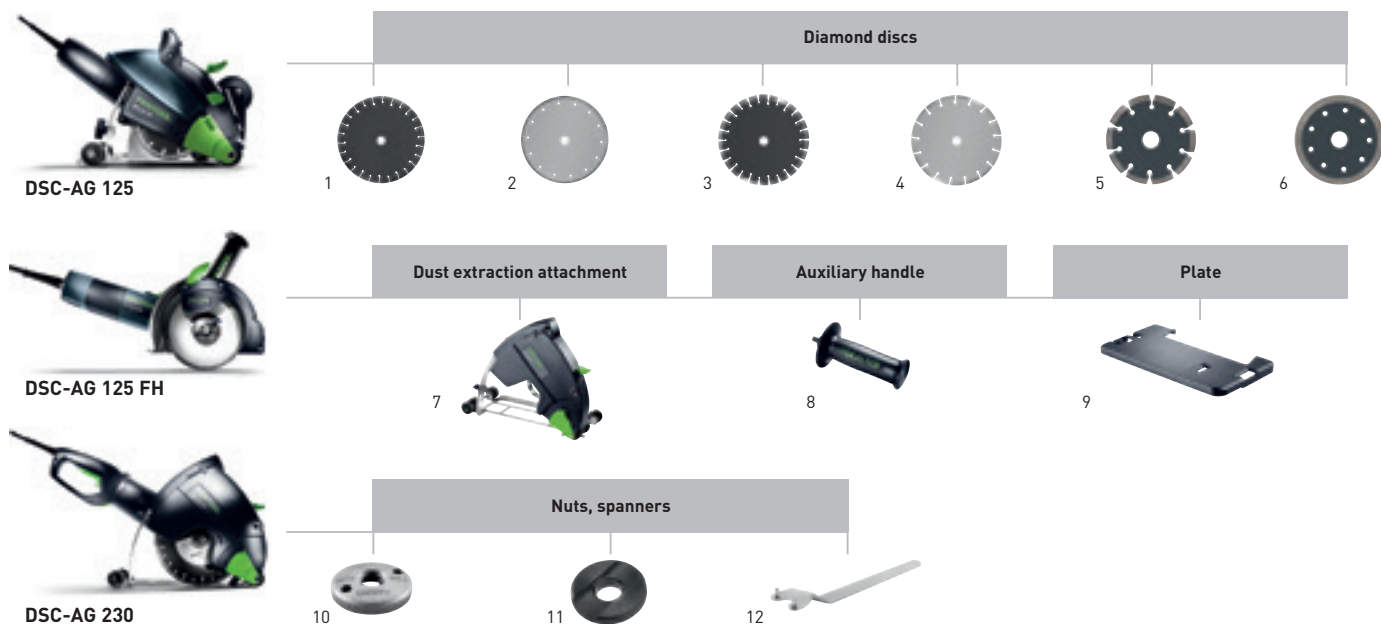

Accessories for DSC-AG 125, DSC-AG 125 FH and DSC-AG 230 diamond cutting systems

Denomination	Explanation	Order no.
1 Diamond disc ALL-D 125 PREMIUM	for DSC-AG 125, DSC-AG 125 FH, AGP 125, WCP 32, universal range of applications, dia. 125 mm, holder dia. 22,2 mm, in self-service display pack	769154
Diamond disc ALL-D 230 PREMIUM	for DSC-AG 230, AGP 230, universal range of applications, dia. 230 mm, holder dia. 22,2 mm, in self-service display pack	769155
2 Diamond disc ALL-D 125 STANDARD	for DSC-AG 125, DSC-AG 125 FH, AGP 125, WCP 32, universal range of applications, dia. 125 mm, holder dia. 22,2 mm, in self-service display pack	769156
Diamond disc ALL-D 230 STANDARD	for DSC-AG 230, AGP 230, universal range of applications, dia. 230 mm, holder dia. 22,2 mm, in self-service display pack	769157
3 Diamond disc C-D 125 PREMIUM	for DSC-AG 125, DSC-AG 125 FH, AGP 125, WCP 32, for concrete, dia. 125 mm, holder dia. 22,2 mm, in self-service display pack	769158
Diamond disc C-D 230 PREMIUM	for DSC-AG 230, AGP 230, for concrete, dia. 230 mm, holder dia. 22,2 mm, in self-service display pack	769159
4 Diamond disc C-D 125 STANDARD	for DSC-AG 125, DSC-AG 125 FH, AGP 125, WCP 32, for concrete, dia. 125 mm, holder dia. 22,2 mm, in self-service display pack	769160
Diamond disc C-D 230 STANDARD	for DSC-AG 230, AGP 230, for concrete, dia. 230 mm, holder dia. 22,2 mm, in self-service display pack	769161
5 Diamond disc MJ-D125 PREMIUM	for DSC AG 125, DSC-AG 125 FH, AGP 125, For cleaning grouted joints., dia. 125 mm, holder dia. 22,2 mm, width 6,5 mm, in carton	769087
6 Diamond disc TL-D125 PREMIUM	for DSC AG 125, DSC-AG 125 FH, AGP 125, for cutting tiles, dia. 125 mm, holder dia. 22,2 mm, in self-service display pack	769162
7 Dust extraction attachment DCC-AG 125	for AG 125, AGP 125-12/14, for the reduction of dust, hexagon socket wrench, Clamping flange, Spanner, dia. 125 mm, weight 2,2 kg, dust extraction connection dia. 36/27 mm, in carton	769075
Dust extraction attachment DCC-AG 125 FH	for AG 125 and AGP 125-14, for dust-free work with the angle grinder, hexagon socket wrench, dia. 125 mm, dust extraction connection dia. 36/27 mm, weight 0,6 kg, in carton	769953
Dust extraction attachment DCC-AG 230	for AG 230, AGP 230-22/26, for the reduction of dust, hexagon socket wrench, Clamping flange, Spanner, dia. 230 mm, weight 3,2 kg, dust extraction connection dia. 36/27 mm, in carton	769077
Rubber gasket DR-DCC-AG 230	for DCC-AG 230, DCC-AGP 230, increase efficiency of dust extraction, in self-service display pack	769092
8 Auxiliary handle AH-M8 VIBRASTOP	for AG 125, AGP 115, AGP 125, AGP 150, VIBRASTOP, holder M8, in self-service display pack	769620
Auxiliary handle AH-M14 VIBRASTOP	for AG 230, AGP 180, AGP 230, VIBRASTOP, holder M14, in self-service display pack	769621
9 Plate TP-DSC-AG 125 FH	for DSC-AG 125 FH Plus, DCC-AG 125 FH, protects the surface against possible signs of abrasion during cutting, for fastening at guide table of extraction hood DCC-AG 125 FH, dimensions (L x W x H) 195 x 103 x 14 mm, in self-service display pack	200002
10 Clamping nut UF-AG M14	for DSC-AG 125/230, DSG-AG 125 and RG 130, for disc Ø 115-230 mm, Front clamping flange, for clamping the grinding disc, up to BJ 02/2015, holder M14, in self-service display pack	769018
Clamping nut UF-DSC/DSG-AG M14	for DSC-AG 125/230, DSG-AG 125 and RG 130, for disc Ø 115-230 mm, Front clamping flange, for clamping the grinding disc, from BJ 03/2015, holder M14, in self-service display pack	200241
11 Flange BF-AG 22,2	for DSC-AG 125/230, for disc Ø 115-230 mm, Rear clamping flange, for clamping the grinding disc, holder 22,2 mm, in self-service display pack	767973
12 Key KF-AG	for DSC-AG 125/230, for flange, in bag	769040



TP 220

Replacement rollers



1



TPE

Extension handle



2

Carpet remover blade

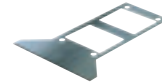

3

Accessories for TP 220 wallpaper perforator and TPE carpet remover

Denomination	Explanation	Order no.
1 Replacement roller EW-TP 220	for TP 220, 2 rollers, in self-service display pack	496111
2 Extension-handle SG-TPE/RS 1	with 2 additional hand grips and shoulder cushion, in two sections, allows use of TPE in standing position, length 1.700 mm, in carton	486375
3 Carpet remover-blade TM 195	for TPE-RS 100, blade width 195 mm, in carton	486374



Illuminating

Overview of products and applications	386
Working light SYSLITE UNI	387
Working light SYSLITE KAL II	388
Working light SYSLITE DUO	389
Surface control light SYSLITE STL 450	390
Accessories and consumable materials	391
The Festool system	

Illuminating

Overview of products and applications

NEW

Page 387 — 388 — 389 — 390

SYSLITE UNI

SYSLITE KAL II

SYSLITE DUO

SYSLITE STL 450



Applications

For illuminating smaller surface areas

For illuminating larger areas

For illuminating large rooms

For inspecting surfaces

Work independent of the mains power supply



Extremely appropriate



Appropriate



SYSLITE UNI



The light to the tool.

- ▶ Three powerful, energy-efficient, high-performance LEDs
- ▶ Lamp head can be adjusted into nine different positions by a vertical angle of 135°
- ▶ Stable and tilt-resistant, or can be flexibly attached using belt clip and trestle hook

Technical data

Battery voltage (V)	10,8/18
Light source	3 SMD LEDs
Lumen value (lm)	43
Weight (without battery pack) (kg)	0,34

Small, but surprisingly powerful.

The handy SYSLITE UNI is always ready to light up dark corners. Its lightweight and compact design makes it a welcome working aid. It is compatible with all conventional Festool batteries.

not available in Great Britain

Battery and charging technology
from page 10 onwards

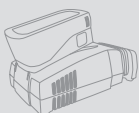

Illuminating

SYSLITE KAL II working light



product
design award

2012



SYSLITE KAL II



Total flexibility.

Five available installation and mounting positions: The SYSLITE KAL II lights up the darkest of corners for up to six hours non-stop. The housing is made from shatter-proof, shock-proof and impact-resistant cast aluminium – durable enough for any construction site. The large light dispersion angle of 170° ensures that the entire work surface is illuminated uniformly.

The light to the tool.

- ▶ Excellent light thanks to 12 high-performance LEDs
- ▶ Long life and robust thanks to shatter-proof housing
- ▶ Continuous use – any Festool battery pack can be attached to supplement the internal battery. The 230 V mains power pack and vehicle charging cable offer additional charging and power supply options
- ▶ Compact design – can be flexibly positioned without cable hazards

Technical data

Light source (W)	12 x 1,5
Lumen value 1st/2nd stage (lm)	310/769
Operating time (internal battery) 1st/2nd stage (min)	290/110
Li-ion battery capacity (Ah)	2,9
Li-ion charging time (min)	200
Permissible operating temperature range (°C)	-5/+ 55
Operation with external Festool battery packs (V)	10,8 – 18
Hook opening (mm)	40
Thread size stand (*)	1/4
Dimensions (L x W x H) (mm)	80 x 100 x 150
Weight (without battery pack) (kg)	0,7

Items included

integrated lithium-ion battery 7.2 V, car charger adapter, 230 V adapter, transport bag, in self-service display pack

KAL II GB 240V

Order no.

500722

KAL II-Set GB 240V

magnetic spherical head with flat disc

499816

System accessories from page 391



Battery and charging technology from page 10 onwards





SYSLITE DUO

Because light quality is reflected in the quality of your work.

- ▶ Unique LED configuration for 180° scattering angle and homogeneous illumination
- ▶ High illuminating power (8000 lm) for brilliant lighting of a large surface area
- ▶ Daylight-like colour (5000 K)
- ▶ Sturdy and durable with 10,000-hour lifetime (L70) and shock-proof corners

Technical data

Colour (K)	5.000
Light source (W)	80 x 1,4
Lumen value (lm)	8.000
LED service life (L70) (H)	10.000
Colour rendering index, Ra	80
Housing protection class	IP 55
Safety class	1
Cable length (m)	4,8
Weight (kg)	3,4

Items included

	Order no.
in SYSTAINER SYS 3 T-LOC	
DUO-Plus GB 240V	769965
DUO-Set GB 240V ST DUO 200 tripod	574656



A new generation of light.

Illuminates extensively, instead of selectively. Can be used with the stable tripod extended up to a height of 2.00 m and stowed away safely in a SYSTAINER. One-hand grip, suspension means and cord holder? But of course.

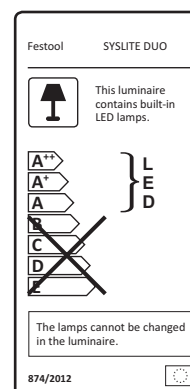

System accessories from page 391



Illuminating

SYSLITE STL 450 inspection light

NEW



SYSLITE STL 450



Detects faults before anyone else does.

- ▶ The newly developed and unique Festool optics produce such a highly focused light cone that you can immediately detect any unevenness and flaws on the primed surface
- ▶ Check your end result during the work process itself, and thereby achieve the perfect surface
- ▶ Thanks to its robust plastic housing and long LED service life, the inspection light is optimally equipped for tough building site conditions and is maintenance-free

Technical data

Lumen value (lm)	1.500
Colour (K)	5.000
Housing protection class	IP 55
Cable length (m)	5
Weight (kg)	1,5



Adjusts according to your needs.

Using the tripod and flexible adapter, the grazing light can be immediately made ready for use at the desired height and inclination

Items included

Items included	Order no.
STL 450 GB 240V in bag	201940
STL 450-Set GB 240V AD-ST DUO 200 adapter, ST DUO 200 tripod, in carton	202914

System accessories from page 391





Accessories for SYSLITE UNI, SYSLITE KAL II, SYSLITE DUO work lights, SYSLITE STL 450 inspection light

Denomination	Explanation	Order no.
1 Battery pack BP 18 Li 5,2 AS	with AIRSTREAM function, lithium-ion (Li-ion) replacement battery pack for all Festool 18 V cordless tools (except CXS/TXS, RTSC, DTSC, ETSC), tensioner 18 V, capacity 5,2 Ah, weight 0,7 kg, in self-service display pack	200181
Battery pack BP 18 Li 5,2 AS-ASI	Bluetooth lithium-ion (Li-ion) battery pack with AIRSTREAM function for all Festool 18 V cordless tools (except CXS/TXS, RTSC, DTSC, ETSC), Bluetooth enables the CLEANTEC mobile dust extractor to be started automatically when the cordless tool is switched on (use of the Bluetooth module at the free slot on the CLEANTEC mobile dust extractor is required), tensioner 18 V, capacity 5,2 Ah, weight 0,7 kg, in carton	202479
Battery pack BP 18 Li 6,2 AS-ASI	Bluetooth lithium-ion (Li-ion) battery pack with AIRSTREAM function for all Festool 18 V cordless tools (except CXS/TXS, RTSC, DTSC, ETSC), Bluetooth enables the CLEANTEC mobile dust extractor to be started automatically when the cordless tool is switched on (use of the Bluetooth module at the free slot on the CLEANTEC mobile dust extractor is required), tensioner 18 V, capacity 6,2 Ah, weight 0,7 kg, in carton	201797
Battery pack BP 18 Li 3,1 C	compact, lightweight design, lithium-ion (Li-ion) replacement battery pack for all Festool 18 V cordless tools (except TSC 55, CXS/TXS, RTSC, DTSC, ETSC), tensioner 18 V, capacity 3,1 Ah, weight 0,4 kg, in self-service display pack	201789
2 Rapid charger TCL 6 GB 240V	for all Li-ion battery packs (except for CXS/TXS), Lithium-ion (Li-ion) replacement charger for all 10.8 – 18 V battery packs, charging current 6 A, input voltage 220 – 240 V, weight 0,8 kg, in self-service display pack	201136
Rapid charger SCA 8 GB 240V	for all Li-ion battery packs (except for CXS/TXS), with AIRSTREAM function, Lithium-ion (Li-ion) replacement charger for all 10.8 – 18 V battery packs, charging current 8 A, input voltage 220 – 240 V, weight 1,1 kg, in self-service display pack	200311
Battery and charging technology	from page 10	
3 Magnetic spherical head MA KAL	for Festool guide rail clamps, spherical head can be rotated 360°, for flexible positioning of the work light SYSLITE KAL and KAL II, pad for external stand, magnetic holding force 16 kg, in self-service display pack	499814
4 Tripod ST DUO 200	for SYSLITE DUO, continuously height-adjustable from 150 to 200 cm via two pull-outs, folds to save space and easy to transport at just 5,6 kg, in carton	200038
5 Adapter AD-ST DUO 200	for SYSLITE STL 450 inspection light, for attaching to the ST DUO 200 tripod, weight 1,1 kg, in carton	201936

See everything. Work with more precision. With the right light for every situation.

The SYSLITE DUO working light, the SYSLITE KAL work light, the portable SYSLITE UNI or the SYSLITE STL 450 inspection light for surfaces – whichever you choose, all our lighting solutions are developed with the same aim in mind as our tools: Making your work easier, and improving your results, by providing excellent lighting for every situation – from small surfaces through to entire rooms. Because high-quality lighting is essential for good work.



SYSLITE UNI

Small and compact for ultimate mobility. Compatible with all Festool battery packs.

SYSLITE KAL II

Turns dark surfaces into work surfaces in an extremely versatile manner. Can be positioned or suspended in five positions and powered by a wide variety of sources (internal battery, battery pack, mains cable or car charger).

SYSLITE DUO

Extensive illumination (mains-powered) of entire rooms with light quality that replicates daylight. Can be used in a wide variety of ways: Stands alone on the floor or flat surfaces, attaches to the Festool tripod or, if preferred, hangs on hooks using the suspension means on the rear side of the SYSLITE DUO.

SYSLITE STL 450

The inspection light optimally focuses the light – ideal for inspecting surfaces even when working. Variable height and inclination with compatible tripod and long cable for a large range of applications.

Overview of the lights:

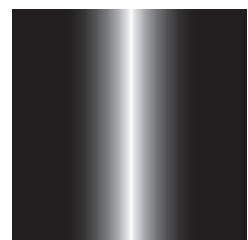
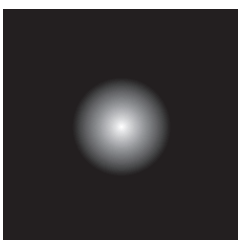



With the SYSLITE STL 450 inspection light you can inspect surfaces while working, benefitting from perfect results and satisfied customers from the outset.

The most powerful member of the Festool's range of lights: The SYSLITE DUO.

Because light quality is reflected in the quality of your work. Experience the difference:



Classic halogen lamp
Yellow luminous colour, diminishes in peripheral vision.



Conventional LED light
Blue light colour, small light dispersion angle, lower luminosity.



Festool SYSLITE DUO
180° scattering angle, uniform two-dimensional illumination, replicates the colour of daylight.



Plus: Thanks to SERVICE all-inclusive, if any of our working lights and inspection lights don't meet your requirements you can return them up to 15 days from purchase and receive a full refund. For more information and details of other services, visit www.festool.co.uk/service



Workplace organisation

Compact Module System CMS	396
Multifunction table MFT 3	398
Vacuum clamping system VAC-SYS	399
Guide rail FS/2	400
Dual suction pad GECKO	401
Vacuum clamping nozzle CT WINGS	402
Boom arm ASA	403
Energy box EAA	404
Workcenter WCR 1000	405
Multifunction stool MFH 1000, UCR 1000	406
Toolcenter TC 3000/2	407
Construction site radio SYSROCK BR 10, BR 10 DAB+	408
Power distributor SYS-PowerHub	409
Storage systems SYSTAINER, SORTAINER, SYS-ToolBox	410
Transportation systems SYS-Port, SYS-Roll, SYS-Cart	411
Accessories and consumable materials	412
The Festool system	

Workplace organisation

The CMS Compact Module System

CMS Compact Module System. Open to change.

Five machines in one. Stationary or handheld. Covers 0.5 m². Only possible with a system. The CMS Compact Module System consists of a basic unit and compatible modules that transform the unit into a stationary bench-mounted saw, jigsaw, bench-mounted router or belt sander.

Safe and convenient.

The machines can be switched on and off from the basic unit.

Mobile and stable.

At only 10.8 kg, the basic unit is extremely lightweight yet robust.

Adjustable height.

Foldaway legs on the basic unit allow you to work on the floor or standing up.

Easy to extend.

A comprehensive selection of accessories such as the sliding table, angle stop and extension table are available so the CMS can be adapted for a wide range of applications.

CMS modules



TS 55 R Plunge-cut saw
Page 40



Module mounting CMS-TS 55 R
Page 43



Module CMS-MOD-TS 55-R
Page 43



Circular saw TS 75
Page 42



Module mounting CMS-TS 75
Page 43



Module CMS-MOD-TS 75
Page 43



Router OF
Page 248



Module mounting CMS-OF
Page 252



Pendulum jigsaws PS
Page 36



Module mounting CMS-PS
Page 39
ADT-PS 400 adapter table
Page 62



(PS 420/400)



All modules in the established Basis-Plus System can be combined with the basic unit of the CMS, except for the Basis 1 A module.



Module CMS-MOD BS 120
Page 119

Workplace organisation

The CMS Compact Module System

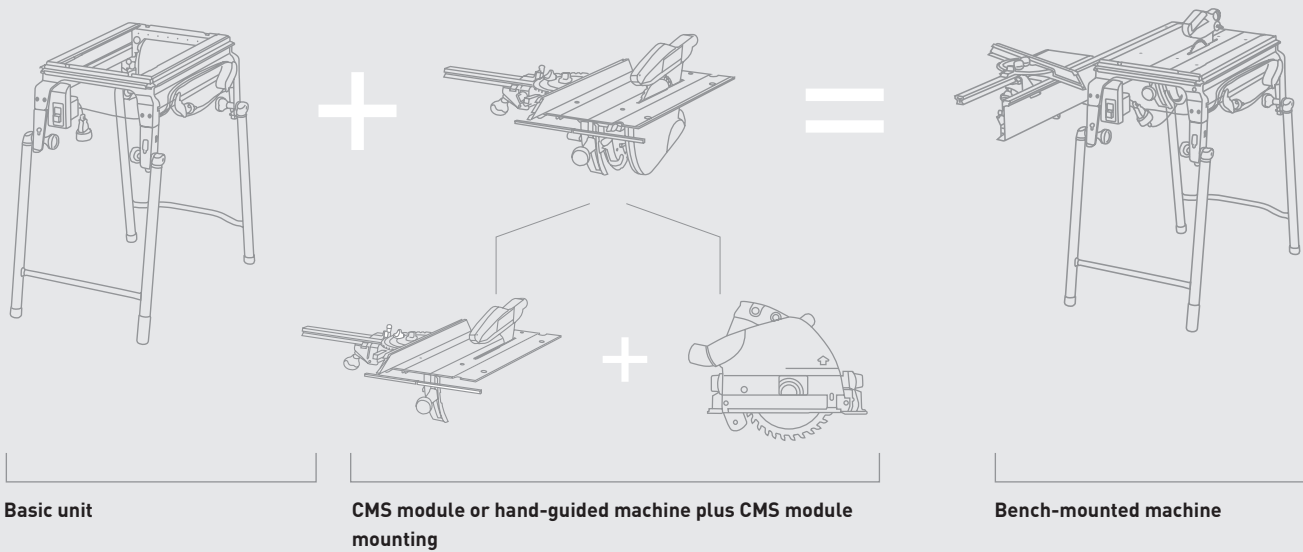

Basic unit

Bench-mounted machine

+

+

+

+

+



Technical data

Table height, legs unfolded	900 mm
Table height, legs folded away	316 mm
Table dimensions	585 x 400 mm
Weight	10.8 kg

Delivered parts

Basic unit CMS-GE
 Basic unit for fitting CMS modules,
 foldaway legs, main safety switch,
 cable holder/workpiece holder, cable
 and socket

Order no.

561228

=

=

=

=

=



Bench saw CMS-TS 55 R Set
Page 43



Bench saw with TS 75



Bench-mounted router TF 2200 Set
Page 253

TF 1400 set
Page 253

Bench-mounted router with OF 1010



Bench-mounted jigsaw with PS



Bench-mounted belt sander with BS 120

Workplace organisation

Multifunction table MFT 3

MFT 3



Always the right accessories.

Everything is secured safely in place, from guide rails to combination bevvels. The MFT/3 extension allows the insertion of all CMS modules, while the sliding table enables cross cuts with a maximum width of 830 mm.



1 table. 1000 possibilities.

- ▶ Maximum precision – with aluminium profile for retaining a guide rail and the angle stop
- ▶ Angle stop, stop slide and additional clamping device ensure exact results
- ▶ Ergonomic work position thanks to the table height of 90 cm
- ▶ Mobile use of the MFT 3 through space-saving foldaway legs

Technical data

Table dimensions (mm)	1.157 x 773
Table height, legs folded away (mm)	180
Table height, legs unfolded (mm)	900
Max. workpiece thickness (mm)	78
Max. workpiece width (mm)	700
Load capacity (kg)	120
Weight (kg)	28

Items included

table with perforated top and foldaway legs, in carton

MFT/3

swivel unit, support unit, angle stop, adjustable stop, guide rail FS 1080/2, deflector FS-AW, additional clamp

MFT/3 Basic

Order no.

495315

500608

System accessories from page 415

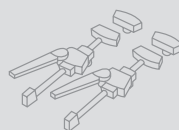



VAC SYS

The future of clamping.

- ▶ Workpieces can be turned up to 360° and swivelled up to 90°
- ▶ Sensitive surfaces can be clamped without damaging them
- ▶ Powerful control – each clamping unit can secure workpieces up to 30 kg and 1 x 1 m
- ▶ For mobile use – pump and clamping units are stored in a SYSTAINER for easy transportation

Technical data

Min. power consumption at 50 Hz (W)	160
Max. power consumption at 50 Hz (W)	200
Power consumption at 50 Hz (W)	160 – 200
Power consumption at 60 Hz (W)	200 – 230
Pump capacity at 50 Hz (m³/h)	2,7
Pump capacity at 60 Hz (m³/h)	3,5
Minimum vacuum	≥ 81% / ≥ 810
Weight (kg)	8



Items included

Items included	Order no.
VAC SYS SE 2 vacuum pad VAC SYS VT 275 x 100 mm, vacuum hose, connector, in SYSTAINER SYS 4	580062
VAC SYS Set SE1 GB 240V vacuum clamping unit VAC SYS SE1, vacuum pump VAC SYS VP, foot valve, vacuum hose, in carton	712257
VAC SYS VP GB 240V in carton	580072



Pads replaced without using tools.

There are four pad sizes for different workpieces to choose from and they can be replaced quickly with FastFix.

System accessories
from page 416



Workplace organisation

Guide rail FS/2

The guide rail is available in 8 different lengths, from 800 mm to 5000 mm.



FS/2



Suitable for furniture construction.

A router and guide rail with rows of holes simplify the installation of shelves or fittings.

Impeccable guidance.

- ▶ Zero-play guidance – you can adjust the guidance jaws on the circular saw to fit the guide rail without using tools
- ▶ Splinter-free cuts – the splinter guards positioned directly on the scribe line prevent the edges from splintering, even on angled cuts
- ▶ Precision results – the router guide stop was designed for precision grooves
- ▶ Quick for diagonal cuts – with guide rail and combination bevel, angles are easy to transfer from the workpiece or wall

Items included	Order no.
in carton	
FS 800/2	491499
FS 1080/2	491504
FS 1400/2	491498
FS 1900/2	491503
FS 2400/2	491502
FS 2700/2	491937
FS 3000/2	491501
FS 5000/2	491500
FS 1400/2-LR 32	496939
FS 2424/2-LR 32	491622

FS 800/2 = length 800 mm; FS 1080/2 = length 1080 mm; FS 1400/2 = length 1400 mm, etc.
FS 1400/2-LR 32 and FS 2424/2-LR 32 = guide rails with rows of holes spaced 32 mm apart.

System accessories from page 418

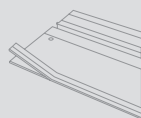



GECKO

Secure connection for a long time.

- ▶ Ergonomic – the torsionally rigid handle makes it much easier to lift heavy loads
- ▶ Retains the position, preserves the material – special sliding rings mounted on both suction cups allow you to position the GECKO precisely and release it just as easily
- ▶ Secure hold – the green clamping levers provide quick and reliable suction. For a loading capacity of 50 kg
- ▶ Designed for a system – the GECKO can be mounted directly to a guide rail using the guide rail adapter



Designed for a system.

The GECKO can be mounted directly to a guide rail using the guide rail adapter.

Technical data

Load capacity (kg)	50
--------------------	----

Items included

in self-service display pack

Order no.

GECKO DOSH	492617
-------------------	---------------

GECKO DOSH-Set

adapter DOSH-FSAD, dual suction pad GECKO DOSH

493507

System accessories
from page 418

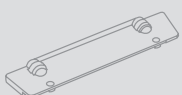

Workplace organisation

Vacuum clamping nozzle CT WINGS



CT WINGS



Assembly aid through suction force.

The practical assembly aid for clamping and fixing workpieces on horizontal and vertical areas. Simply position CT WINGS at a 27 mm suction hose with machine sleeve, switch on the mobile dust extractor and then the workpiece is held in place with the suction power.

The third hand. Precisely when you need it.

- ▶ In many cases replaces the assistant when it comes to having a free hand for marking, clamping, gripping, etc.
- ▶ For effortless, precise and safe work
- ▶ Small, compact and always at hand
- ▶ Perfect in the system – in combination with a Festool mobile dust extractor and suction hose with 27 mm diameter

Technical data

Max. clamping height (mm)	50
Max. load (kg)	3
Dimensions (L x W x H) (mm)	130 x 80 x 50
Weight (kg)	0,35

Items included

CT-W
in self-service display pack

Order no.

500312

CT mobile dust extractor
from page 178 onwards





For large working areas.

- ▶ Maximum flexibility, extra safety, no dangerous obstacles
- ▶ For use with Festool CT/SRM mobile dust extractors
- ▶ Integrated compressed air and electrical lines for connection to EAA and CT
- ▶ Saves time, space and increases economic efficiency

Technical data	ASA 5000	ASA 6000
Connecting cable length (m)	3	3
Boom extension (m)	2 x 2,5	2 x 3
Application area (m ²)	39 - 58	56 - 84
Weight (kg)	92	105
Cutting angle adjustment (°)	39 - 58	56 - 84

not available in Great Britain



Workplace changes made easy.

Boom arms are primarily used in locations where workplaces need to be flexible or where a large operating radius is required. Power and dust extraction is supplied where it is needed, while avoiding tripping hazards. This saves you time moving equipment and creates more space in the workshop.

System accessories
from page 417

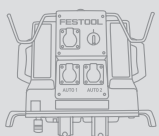

Workplace organisation

EAA energy box CT/SR



EAA



Sophisticated design right down to the smallest detail.

The EAA, with manually or automatically operated sliders for use with CT mobile dust extractors or the TURBO II central exhaust, spares the user from cumbersome handles and travels, and ensures optimal dust extraction. Electric power tools and air tools are ready for use and ready to hand at all times.

For greater ease of movement.

- ▶ Manual or automatic adjustment of the slide valve provides suction power wherever an electric and/or air tool is in operation
- ▶ Flexible – the EAA can be mounted on a ceiling, wall or boom arm
- ▶ Always ready for use by up to 2 electrical and/or compressed air power tools (depending upon the version of the EW/DW)
- ▶ Better organisation – two hoses can be stored and kept clean in the hose holders on the rear of the EAA

Technical data	EAA EW CT/SRM/M	EAA EW/DW CT/SRM/M	EAA EW/DW TURBO/A
Dimensions (L x W x H) (mm)	506 x 580 x 367	516 x 580 x 367	516 x 580 x 367
Pressure range (bar)	4 – 8	4 – 8	4 – 8
Weight (kg)	10,2	13	13,8

not available in Great Britain

System accessories
from page 417





WCR 1000



Mobility in the tightest of spaces.

- ▶ Compact and mobile – the WCR can be coupled with any Festool mobile dust extractor with integral SYS-Dock (except CTL MINI/MIDI)
- ▶ Flexible equipment – hooks for hanging two machines with extractor hoses, a universal holder, storage compartment and rotating storage tray for sundries
- ▶ Individual extension – additional storage trays, hooks or holders can be mounted on the perforated plate and profiled groove
- ▶ Work without straining your back – the height of the Workcenter, hooks and storage trays is easy to adjust

Technical data

Length (mm)	1.050
Width (mm)	362
Height adjustable (mm)	545 – 785
Size of square hole pattern (mm)	9,2 x 9,2
Inner hole distance of square hole pattern (mm)	38
Weight (kg)	10,2

Items included

WCR 1000
Storage shelf, storage trough, storage base for pegboard, double tool hook, double universal hook, 6 x standard hooks (125 mm long), 2 x pegboards with square holes, SYSTAINER retainer, in carton

Order no.

497471

Customised configuration.

SYSTAINER sizes 1 to 4 or SORTAINERS can be integrated into the Workcenter.

System accessories from page 420



Workplace organisation

Multifunction stool MFH 1000
and Universalcenter UCR 1000

MFH 1000 /
UCR 1000



Clever, mobile organisation.

Pull-out drawer that can be locked – for storing accessories, work equipment and personal effects.

Mobile seating arrangement, efficient work.

- ▶ Multifunction stool MFH 1000 + Workcenter WCR 1000 = Universalcenter UCR 1000
- ▶ Use the Universalcenter UCR 1000 in mobile applications and benefit from the advantages of the Workcenter WCR 1000
- ▶ Pleasant working environment – without the Workcenter WCR, the multifunction stool MFH 1000 is a stable, comfortable seat
- ▶ Efficient organisation – hooks and storage trays ensure quick access to machines, accessories and work equipment

Technical data	MFH 1000	UCR 1000
Length (mm)		695
Dimensions (L x W x H) (mm)	695 x 436 x 524	
Width (mm)		436
Width of roll (mm)	32	32
Height adjustable (mm)		1.031 – 1.271
Roll dia. (mm)	100	100
Size of square hole pattern (mm)	9,2 x 9,2	9,2 x 9,2
Inner hole distance of square hole pattern (mm)	38,1	38,1
Weight (kg)	27	37

Items included	Order no.
in carton	
MFH 1000 seat cushion MFH 1000 SK, Assembly set	498967
UCR 1000 WCR 1000 Workcenter, multifunction stool MFH 1000 (without seat cushion)	498966

System accessories from page 420





TC 3000/2



Flexibility and extra work space.

- ▶ Beneficial organisation – tools, materials and mobile dust extractor are always stored away tidily and close at hand
- ▶ Mobile equipment – simple transportation between different locations in the workshop
- ▶ Secure attachment – the mobile dust extractor is secured safely in the extractor dock
- ▶ More space – machine and hose holders keep storage areas free for working equipment

Technical data

Dimensions (L x W x H) (mm)	470 x 1.070 x 960
Storage area (mm)	460 x 990
Storage area working height (mm)	925
Weight (kg)	43

Items included

TC 3000/2
hose holder, anti-slip mat, in carton

Order no.

583881

Safety included.

Locking cabinet compartment for size 3 SYSTAINERS or smaller provides safe storage for machines and accessories.

System accessories
from page 421

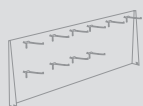

Workplace organisation

SYSROCK BR 10 and BR 10 DAB+ construction site radios



SYSROCK



Light, compact and powerful.

The SYSROCK construction site radios fit on every windowsill and combine compact dimensions with a low weight and impeccable sound. And thanks to the Bluetooth interface, you can listen to your favourite radio stations and tracks from your smartphone with SYSROCK sound quality.

Perfectly formed for perfect sound. Also available as a DAB+ version.

- ▶ Various receiving and playback options via Bluetooth and AUX-IN interfaces – available as analogue or digital radio
- ▶ Integrated USB interface for charging external devices such as mobile devices (with BR 10 DAB+)
- ▶ Excellent sound in a compact, modern and robust design
- ▶ Intuitive operation via large buttons and colour LCD display

Technical data	BR 10 DAB+	BR 10
Radio reception	DAB+ digital radio	FM analogue radio
FM frequency band (VHF) (MHz)	87,5 – 108	87,5 – 108
Speaker (W)	10	10
Operation with Festool slide-in battery packs (V)	18	18
Number of stored stations	2 x 4	4
AUX-IN (mm)	3,5	3,5
Bluetooth standard	4,1	4,1
USB output	5V/1,2A	–
Dimensions (L x W x H) (mm)	95 x 102 x 149	94 x 102 x 149
Weight (kg)	0,7	0,7



Items included	Order no.
230 V adapter, aux-in cable, in bag	
BR10 DAB+ GB 240V DAB+ digital radio	202112
BR 10 GB 240V FM analogue radio	200185

Battery and charging technology
from page 10 onwards

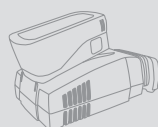



SYS-PowerHub

The first system-integrated power cable in SYSTAINER format.

- ▶ Tidy: There is plenty of room inside for the securely connected 10 m long cable. The SYS-PowerHub also features room for any battery packs or small parts required
- ▶ Can supply power to up to four power tools simultaneously. The internal power socket can also be used to charge a mobile phone, for example, while protecting it against contamination
- ▶ Can be connected to other Systainers even when closed, thanks to the two cable outlets
- ▶ When connected to the mains, the red light on the front signals that it is ready for operation



Technical data

Safety class	IP44
Cable length (m)	10
Power consumption (W)	2.500
Number of sockets	5
Dimensions (L x W x H) (mm)	396 x 296 x 157,5
Inner dimensions (L x W x H) (mm)	383 x 154 x 128
Weight (kg)	4,2

Items included

SYS-PH GB 240V

Order no.

200234

A brand new generation of power distributors.

The new SYS-PowerHub combines all the benefits of a conventional cable drum with the benefits of the Festool Systainer system. With its 10 m cable and four sockets mounted on the exterior, it offers all the freedom that you could need for connecting your power tools.

Workplace organisation

SYSTAINER T-LOC, SORTAINER, SYS-ToolBox

Simply tidier, more clearly arranged and better organised.

SYSTAINERS and SORTAINERS from Festool.

SYSTAINER/SORTAINER – can be stacked or connected, are extremely robust and virtually indestructible.

Machines, accessories and consumable materials are protected from dust, water, changes in temperature and heavy impacts. All your sundries and consumables are stored tidily and are easier to transport – size 1 and 2 SYS T-LOC units can even be carried upright with the attachable additional handle (accessory).

SYS-ToolBox – the open SYSTAINER for instant access.

The sturdy design using high-quality plastic provides a maximum load capacity of 7 kg. Two spacious compartments keep your workplace tidy and an open top gives quick access to hand-held tools, consumables and accessories.



Combines three functions.

The central control element of the SYSTAINER: Lock, open, connect with a single turn.



Secure connection.

In combination with a SYSTAINER or a mobile dust extractor, Systainer-Port and Workcenter WCR.



Easy to open.

The new SYSTAINER T-LOC can be opened at any time without having to be disconnected.



Everything at a glance – the drawers of the SORTAINER offer lots of space for sundries.

1. Individual compartments and additional labelling options provide a better overview.
2. The pull-out catch and individual lock prevent accidental removal of the drawers.
3. A range of different sizes and a modular drawer system offer a SORTAINER to suit every requirement.



Workplace organisation

SYS-Port, SYS-Roll, SYS-Cart



Good for quick transportation.

Everything in its place, stored close at hand at all times. The Systainer-Port, roll board and SYS-Roll SYSTAINER transporter provide greater mobility at the workplace and on assembly sites.



How many SYSTAINERS fit in a SYS-PORT?

Combination options

SYSTAINER size	SYS-PORT 500/2						SYS-PORT 1000/2																																		
	Number of SYSTAINERS						Number of SYSTAINERS																																		
Version	1	2	3	4	5	6	1	2	3	4	5	6	7	8	9	10	11	12	13	14	15	16	17	18	19	20	21	22	23	24	25	26	27	28	29	30	31	32	33		
SYS 1 T-LOC/DF*	3	2	1				8	6	6	5	5	4	4	3	3	3	3	2	2	2	2	2	1	1	1												2	4	1	1	
SYS 2 T-LOC/DF*		1	2	1				1	2	1	1	2	3		1	2	4					2	3	1	1	2	3	4	5										2		
SYS 3 T-LOC/DF*			1	1					1		1	2	1	1	2			3				2	1	2		3	1	1		4	1	1						2			
SYS 4 T-LOC					1					1		1		1		1					2			1	2		1	1					2				1				
SYS 5 T-LOC																																				1	1	2	1	1	
Drawers required**	3	3	2	2	2	1	8	7	7	7	6	6	6	6	5	6	6	5	5	5	5	6	5	4	5	5	4	3	4	4	4	5	5	4	3	4	5	2	3	3	4

* DF = Lid compartment ** The SYS-PORT 500/2 is supplied with 3 drawers, the SYS-PORT 1000/2 with 5 drawers.

From machines to sundries. From the workshop to the assembly site.

	SYSTAINER 1-5 SYS-MFT SYS-Combi	SORTAINER	SYS-ToolBox SYS- StorageBox	MAXI- SYSTAINER	MIDI- SYSTAINER	MINI- SYSTAINER	SYS roller	SYS-Cart	Systainer-Port SYS pull-out
Organisation/Storage									
Power tools	1)	2)		1)					3)
Sundries	1)					1)			3)
Abrasives	1)								3)
Cartridges	1)								3)
Hand tool	1)								3)
Combinations									
SYSTAINER 1-5									
SORTAINER									
SYS-ToolBox I/II									
MAXI-SYSTAINER									
MIDI-SYSTAINER									
MINI-SYSTAINER									
SYS roller									
SYS-Cart									
Systainer-Port									
Mobile dust extractors									
Use/Transportation									
Workshop									
Construction site									

● Extremely appropriate ● Very appropriate ○ Appropriate 1) In combination with insert 2) Only with Sys 3-Sort/4 3) In combination with a suitable SYSTAINER or SORTAINER

The Festool system.

Because things work better when everything fits together: The Festool system always creates a tidy environment and guarantees better organisation.



Workplace organisation

Accessories and consumable materials



Workplace organisation

System accessories

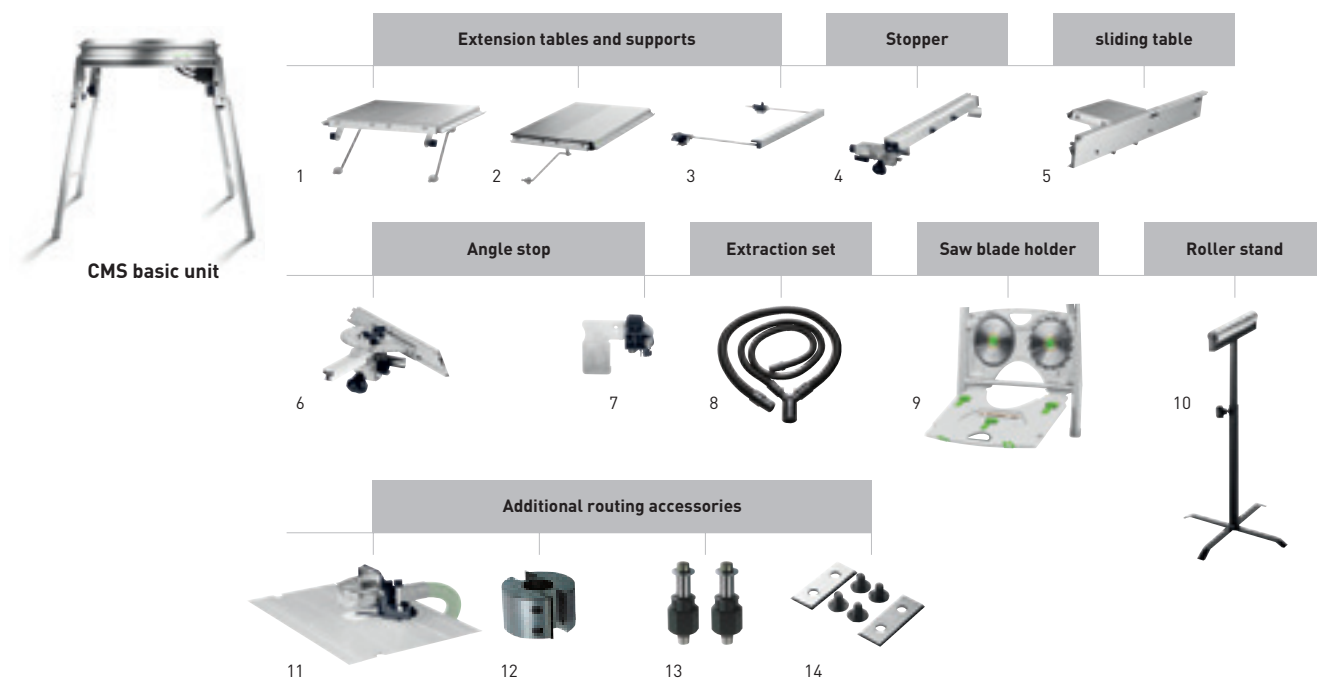

Accessories for Compact Module System CMS

Denomination	Explanation	Order no.
1 Extension table VL	for CS 50, CMS-GE, simple fitting, folds away, for safe support of long workpieces when sawing to width, enlarges the support surface by 405 mm, dimensions 375 x 454 mm, dimensions length x width 375 x 454 mm, in carton	492092
2 Extension table VB-CMS	for CMS-GE, with adjustable dimension scale, extends the support area by 410 mm, cutting width 570 mm, dimensions length x width 664 x 438 mm, in carton	493822
3 Support AF	for CS 50, CMS-GE, support for both side use, supports workpieces while cutting, enlarges the support surface by 300 mm, dimensions length x width 662 x 390 mm, in carton	492242
4 Stopper LA-CS 50/CMS	for CS 50, CMS-GE, with fine adjustment and rear clamp, can be operated from front, with moveable stop profile for precise and safe longitudinal cuts, in carton	492095
5 Sliding table ST	for CS 50, CMS-GE, max. working width for trimming cuts 830 mm, in carton	492100
6 Angle stop WA	for CS 70, CS 50, CMS-GE, for work requiring 2 stops, in carton	488451
7 Adjustable stop WA-AR	for CS 50, CS 70, to stop workpieces on trimming attachment CS 70 WA, CS 50 WA and Basis WRA 500, in self-service display pack	491712
8 Dust extraction set CS 70 AB	for CT/CTM, comprising: dust extraction hose D27x2.0 m, dust extraction hose D36x1.0 m, Y terminal, can be used with Basis, CS 70, CS 50 and CMS, dust extraction with MINI/MIDI only possible in combination with adapter hose 499196, diameter 27 /36 mm, in carton	488292
Adapter hose AD-D 36/CS50/CS70/CMS	for CS 50, CS 70, CMS, 0.5 m hose D36 with two rotating adapters and connection coupling, anti-static D50/D50 VM-AS, for Y-shaped connection in conjunction with CTL MINI/MIDI, length 0,5 m, diameter 36 mm, in carton	499196
9 Saw blade holder SGA	for CS 50, CMS-GE, for safe and space-saving storage of up to 4 saw blades (max. Ø 190 mm) and up to 3 splinterguards (not included in contents), in carton	492228
10 Roller stand RB	for all semi-stationary devices (CS/KS/CMS), may be used with the CS 50, CS 70, CB 120, Basis Plus System, CMS-GE, multifunction table, to use longer workpieces for longitudinal sections and cross sections and cutting and grinding work, height adjustable 630 – 1.000 mm, in carton	488711
11 Guard BF-OF-CMS	for CMS-OF 1010, for CMS-OF 1400/OF 2000/OF 2200, guard and extractor hood, dust extraction connection dia. 27/36 mm, in carton	494643
12 Rebating head FK D 50x30	for CMS-OF, for use with cutter spindles, diameter 50 mm, in self-service display pack	489284
13 Cutter spindle ASL20/OF1400-OF2200	for CMS-OF 1400/OF 2000/OF 2200, for use with rebating head Basis FK D 50x30 in the Basis 6 A and CMS-OF, in self-service display pack	490131
Cutter spindle ASL20/OF1010	for CMS-OF, allows use of rebating head Basis FK D 50x30 in the Basis 5 A and CMS-OF 1010, in self-service display pack	489285
14 Reversible blade WP 30x12x1,5	for rebating head, qty. in pack 2 piece(s), in self-service display pack	489286

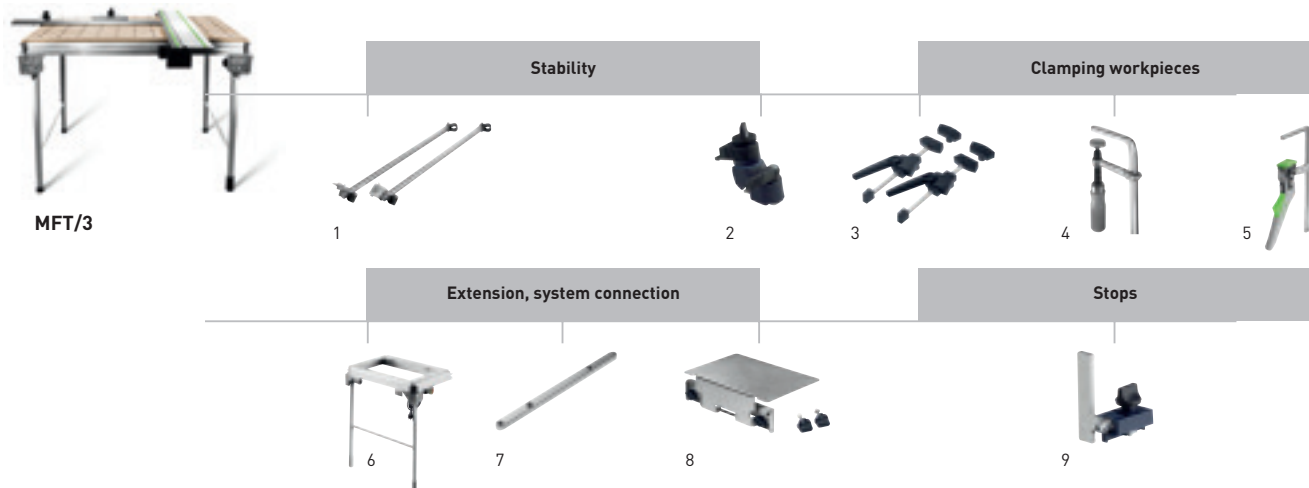

Accessories for the MFT 3 multifunction table

Denomination	Explanation	Order no.
1 Cross brace MFT 3-QT	for additional MFT 3 stability, qty. in pack 2 piece(s), diameter 20 mm, length 675 mm, in carton	495502
2 Additional clamp MFT/3-ZK	for securing the stop rail to the V-groove, in self-service display pack	495541
3 Fixed clamps MFT-SP	for MFT, for safe and precise securing of the workpiece (sawing, sanding, routing, drilling, etc.), qty. in pack 2 piece(s), in self-service display pack	488030
4 Fastening clamp FSZ 120	for FS/2, MFT, solid steel version, clamping width 120 mm, qty. in pack 2 piece(s), in self-service display pack	489570
Fastening clamp FSZ 300	for FS/2, MFT, solid steel version, clamping width 300 mm, qty. in pack 2 piece(s), in self-service display pack	489571
5 Lever clamp FS-HZ 160	for FS/2, MFT, solid steel version, clamping width 160 mm, in self-service display pack	491594
6 Guide extension MFT 3-VL	for the MFT 3, foldaway legs, main safety switch, cable and socket, in carton	not available in Great Britain 495510
7 Connecting piece VS	for attachment of FST660/85 or MFT 800 to Basis Plus, for connecting several MFT 3, in self-service display pack	484455
8 Adapter VAC SYS AD MFT 3	for VAC SYS SE 1, VAC SYS SE 2, for connecting the VAC SYS clamping unit with the MFT 3, in carton	494977
9 Adjustable stop MFT/3-AR	for securing workpieces on the angle stop, Can be folded away, in self-service display pack	495542

Workplace organisation

System accessories

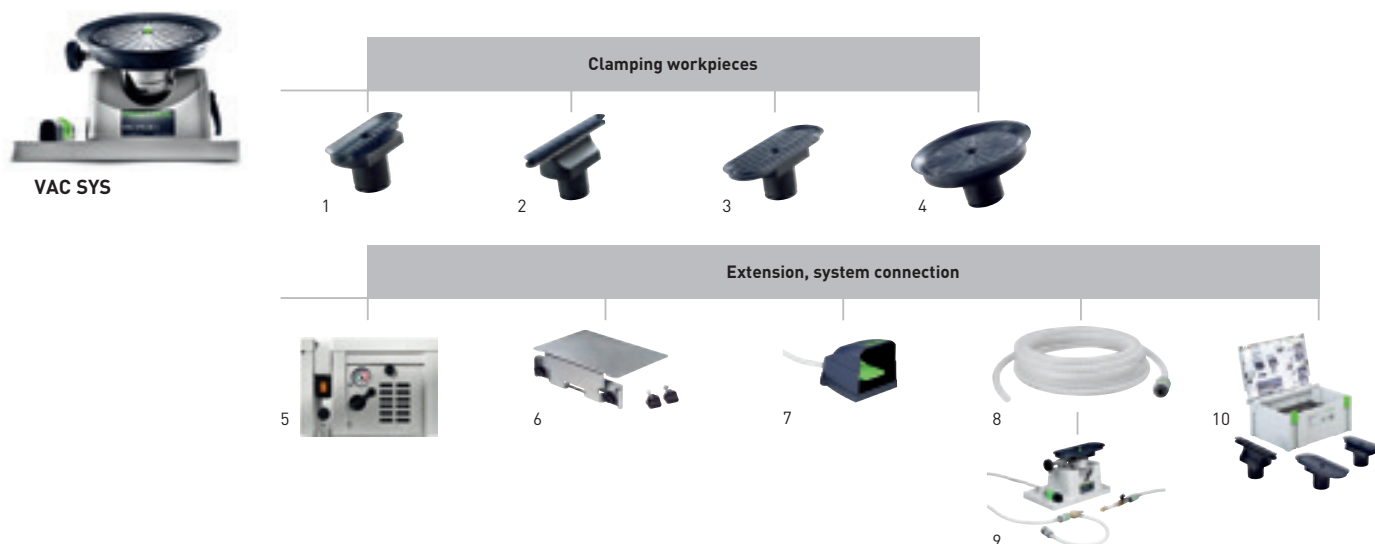

Accessories for the VAC SYS vacuum clamping system

Denomination	Explanation	Order no.
1 Vacuum pad VAC SYS VT 200x60	for VAC SYS SE 1, VAC SYS SE 2, pad dimensions 200 x 60 mm, in carton	580064
2 Vacuum pad VAC SYS VT 277x32	for VAC SYS SE 1, VAC SYS SE 2, pad dimensions 277 x 32 mm, in carton	580065
3 Vacuum pad VAC SYS VT 275x100	for VAC SYS SE 1, VAC SYS SE 2, pad dimensions 275 x 10 mm, in carton	580066
4 Vacuum pad VAC SYS VT D 215	for VAC SYS SE 1, VAC SYS SE 2, diameter 215 mm, in carton	580067
5 Vacuum pump VAC SYS VP	max. power consumption at 50 Hz 200 W, min. power consumption at 50 Hz 160 W, power consumption at 50 Hz 160 – 200 W, power consumption at 60 Hz 200 – 230 W, pump capacity at 50 Hz 2,7 m ³ /h, pump capacity at 60 Hz 3,5 m ³ /h, minimum vacuum ≥ 81%/ ≥ 810, weight 8 kg, in carton	580060
6 Adapter VAC SYS AD MFT 3	for VAC SYS SE 1, VAC SYS SE 2, for connecting the VAC SYS clamping unit with the MFT 3, in carton	494977
7 Foot valve VAC SYS FV	for the VAC SYS SE 1 or in a combination of the VAC SYS SE 1 with the VAC SYS SE 2, for releasing the vacuum pad, in carton	580063
8 Vacuum hose D 16 x 5m VAC SYS	for VAC SYS Set SE 1 and VAC SYS SE2, for guide extension, length 5 m, in carton	495293
9 Vacuum unit VAC SYS SE 2	vacuum pad VAC SYS VT 275 x 100 mm, vacuum hose, connector, max. power consumption at 50 Hz 200 W, min. power consumption at 50 Hz 160 W, power consumption at 50 Hz 160 – 200 W, power consumption at 60 Hz 200 – 230 W, pump capacity at 50 Hz 2,7 m ³ /h, pump capacity at 60 Hz 3,5 m ³ /h, minimum vacuum ≥ 81%/ ≥ 810, weight 8 kg, in SYSTAINER SYS 4	580062
10 Accessories SYSTAINER VAC SYS VT Sort	for VAC SYS SE 1, VAC SYS SE 2, VAC SYS VT 200x60, VAC SYS VT 277x32, vacuum pad VAC SYS VT 275 x 100 mm, also provides space for the VAC SYS VT D 215, in SYSTAINER SYS 3	495294

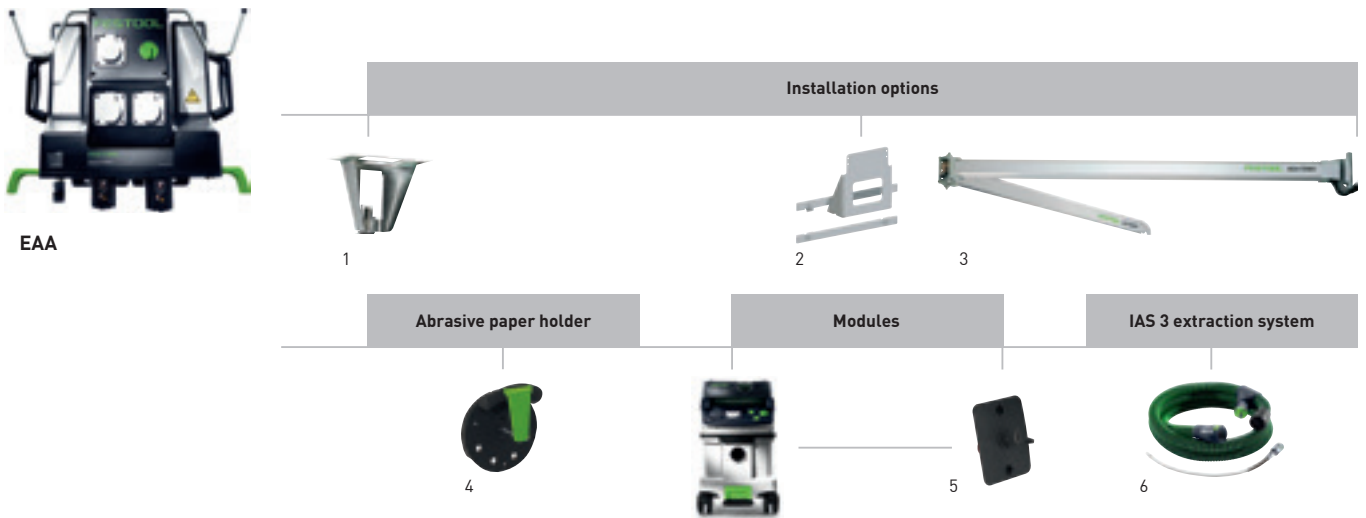

Accessories for the ASA boom arm, EAA energy box

Denomination	Explanation	Order no.
1 Ceiling suspension EAA-D-EU	for energy boxes (models starting in 2009), 2.5 m cable set, 2.5 m compressed air hose, mounting, aluminium tube (1310 mm) with connecting sleeve, in carton	495890
2 Wall mounting EAA-W-EU	for energy boxes (models starting in 2009), 4 m cable sets, 4 m compressed air hose, aluminium tube (350 mm) with connecting sleeve, installation set for energy boxes, in carton	495889
3 Boom arm ASA 5000 CT/SR-EU	for CT mobile dust extractors and SRM extractors, double-jointed arm with wall bracket, cable duct, wall mounting components are not included, connecting cable length 3 m, boom extension 2 x 2,5 m, application area 39 – 58 m ² , weight 92 kg, cutting angle adjustment 39 – 58°, in carton	583867
Boom arm ASA 6000 CT/SR-EU	for CT mobile dust extractors and SRM extractors, double-jointed arm with wall bracket, cable duct, wall mounting components are not included, connecting cable length 3 m, boom extension 2 x 3 m, application area 56 – 84 m ² , weight 105 kg, cutting angle adjustment 56 – 84°, in carton	583868
4 Abrasive paper holder SH-EAA	without mounting hardware, for abrasives up to Ø 150 mm, in carton	496044
5 Energy box module EAA CT 26/36/48	for CT 26/36/48, for connecting a CT mobile dust extractor with an energy box or boom arm, not required in LE version, in carton	496143
6 IAS 3 hose	from page 148	

Workplace organisation

System accessories

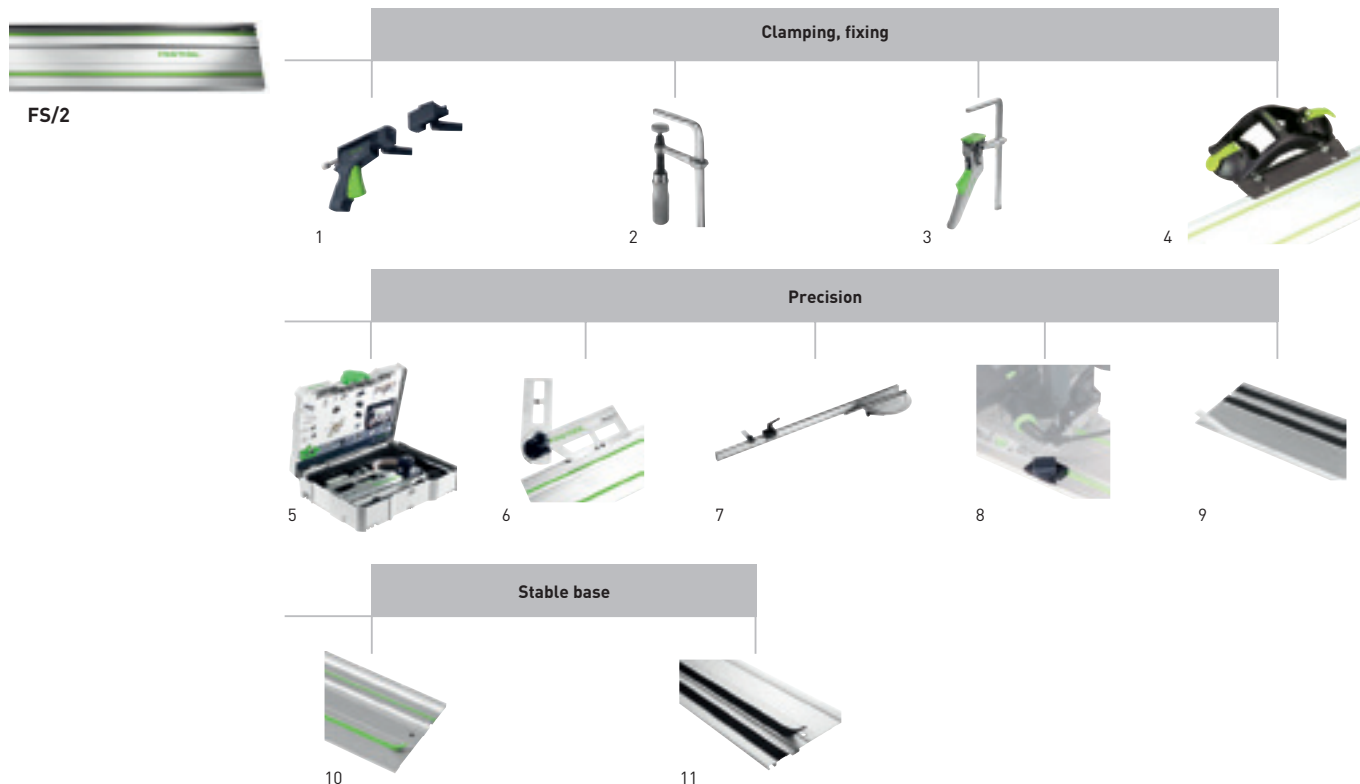

Accessories for the guide rail FS/2

Denomination	Explanation	Order no.
1 Quick-action clamp FS-RAPID/R	for clamping and positioning guide rails FS, FS/2 and GRP/2, Clamping jaws, fixed jaws, in self-service display pack	489790
Quick-action clamp FS-RAPID/L	for use of SSU 200, IS 330 with guide rail, for clamping and positioning with Festool guide rails, fixed jaws, Clamping jaws, in self-service display pack	768116
2 Fastening clamp FSZ 120	for FS/2, MFT, solid steel version, clamping width 120 mm, qty. in pack 2 piece(s), in self-service display pack	489570
Fastening clamp FSZ 300	for FS/2, MFT, solid steel version, clamping width 300 mm, qty. in pack 2 piece(s), in self-service display pack	489571
3 Lever clamp FS-HZ 160	for FS/2, MFT, solid steel version, clamping width 160 mm, in self-service display pack	491594
4 dual suction pad GECKO DOSH	from page 401	
Adapter DOSH-FSAD	to fix the guide rail at the GECKO, in self-service display pack	492616
5 Accessories set FS-SYS/2	2 x clamp FSZ 120, deflector FS-AW, combination angle FS-KS, set-back stop FS-RSP, 2 connecting elements FSV, splinter guard FS-SP 1400, in SYSTAINER SYS 1 T-LOC	497657
6 Combination bevel FS-KS	for FS/2, for angle cuts on guide rail between 0 and 180, in self-service display pack	491588
7 Angle stop FS-AG-2	for FS/2 and GRP/2, for straight angle cuts for use with the guide rail, in carton	768168
8 Kickback stop FS-RSP	for TS 55, TS 55 R, TSC 55, TS 75, HKC 55, HK 55, ATF 55, AP 55, AT 65, AP 65, AP 85, can also be used as guide stop, used as a rear and front stop position on guide rail FS/2, in self-service display pack	491582
9 Splinter guard FS-SP 1400/T	replacement splinterguard for guide rails, transparent, length 1.400 mm, in self-service display pack	495207
Splinter guard FS-SP 5000/T	replacement splinterguard for guide rails, transparent, length 5.000 mm, in self-service display pack	495209
10 Slideway lining FS-GB 10M	replacement sliding surface for guide rail, 10 m length, in self-service display pack	491741
11 Adhesive cushion strip FS-HU 10M	10 m roll, replacement adhesive cushion strip for FS and FS/2 guide rail, in self-service display pack	485724

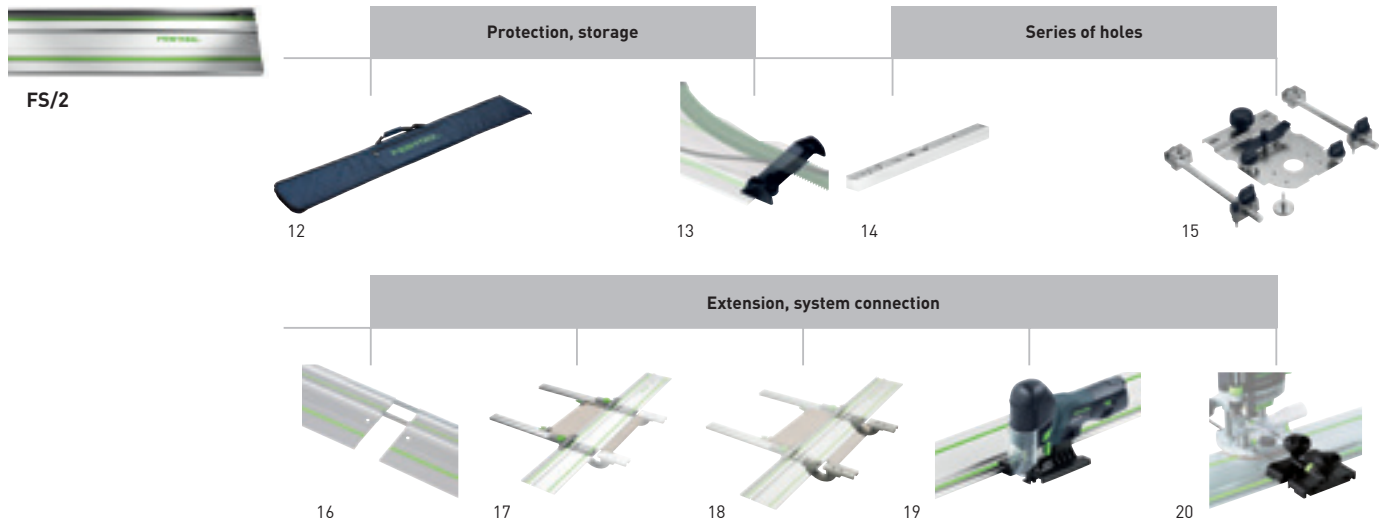

Accessories for the guide rail FS/2

Denomination	Explanation	Order no.
12 Bag FS-BAG	carrying bag with shoulder straps, up to length of FS 1400/2, in bag	466357
13 Deflector FS-AW	prevents suction hoses and cables from catching on the end of the guide rail, in self-service display pack	489022
14 Stopper LA-LR 32 FS	positions the first hole on the hole series guide rail at a distance of 9.5, 16 or 32 mm from the workpiece edge, qty. in pack 2 piece(s), in self-service display pack	496938
15 Hole series system for FS/2	from page 257	
16 Connecting piece FSV	to connect guide rails for long workpieces, qty. in pack 1 piece(s), in self-service display pack	482107
17 Parallel side fence FS-PA	for FS/2, for sawing along the width, for fixed cuts, can be re-set using the scale and end stop, mounting on the guide rail without the use of tools, stop ruler with additional clamp, adjustable stop, max. workpiece width 650 mm, qty. in pack 2 piece(s), in self-service display pack	495717
18 Guide extension FS-PA-VL	for FS/2, only for use with the FS-PA, bridge, stop ruler, scale, max. workpiece width 195 mm, max. material strength 70 mm, qty. in pack 2 piece(s), in self-service display pack	495718
19 Guide rail adapter FS-PS/PSB 300	for PS 200, PS 300, PSB 300, PS 2, allows use of jigsaws with FS and FS/2 guide systems, in self-service display pack	490031
Adapter table ADT-PS 420	for PS(C) 400/420, PSB(C) 400/420, for using the PS on the guide rail, for installation in the Compact Module System CMS, in conjunction with circle cutting attachment KS-PS 400, in self-service display pack	497303
20 Guide stops for routers	from page 267	

Workplace organisation

System accessories

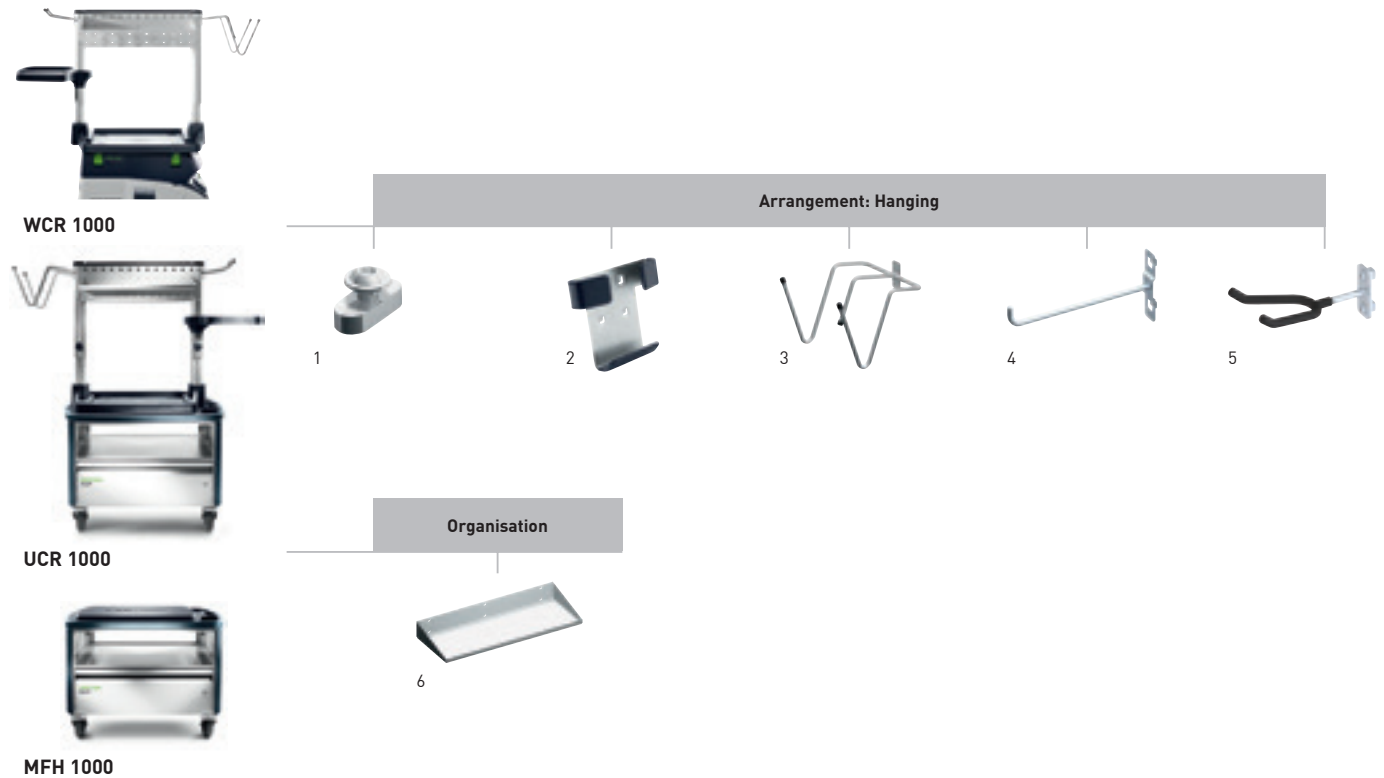

Accessories for Workcenter WCR 1000, Universalcenter UCR 1000, multifunction stool MFH 1000

Denomination	Explanation	Order no.
1 Feather key WCR 1000 PF 2x	for WCR 1000, UCR 1000, The keys enable the attachment of individual accessories to the profiled groove, 2x keys incl. bits, in self-service display pack	497476
2 Pegboard hook HSK LWH HSK-A	for WCR 1000, MFH 1000, UCR 1000, for hanging hand sanding blocks HSK-A 80x130, HSK-A 80x200 and HSK-A 115x226, not suitable for hand sanding block HSK-A 80x400, the protective coating prevents damage, dimensions length x width 38,1 x 38,1 mm, in carton	498968
3 Tool hook WCR 1000 WH	for WCR 1000, UCR 1000, for hanging two tools, for use as a hose holder, in carton	497474
4 Hook WCR 1000 SHQ	for WCR 1000, UCR 1000, Standard hooks for mounting on the pegboard, qty. in pack 6 piece(s), in self-service display pack	497475
5 Holder for spray gun WCR 1000 LPH	for WCR 1000 Workcenter, holder for paint gun, for assembly at the profile groove for the WCR 1000 Workcenter, 2x screw, 2x square nut, dimensions [L x W x H] 148 x 76 x 60 mm, weight 0,5 kg, in carton	498361
6 Storage surface WCR 1000 AB	for WCR 1000, UCR 1000, Large storage surface for placing sundries, boxes of abrasives or screws, etc., in carton	497477

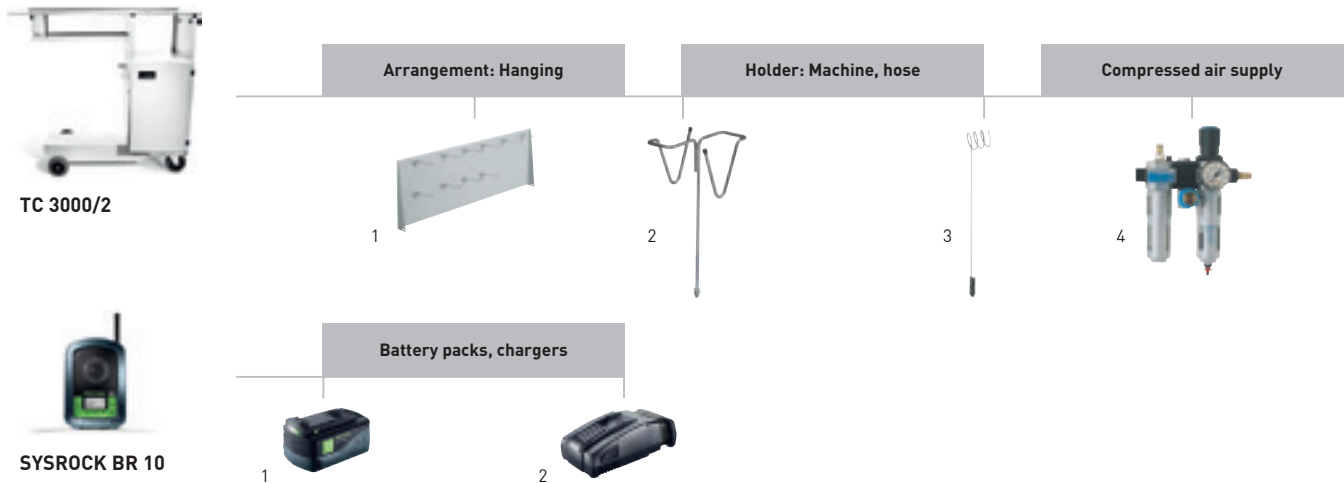

Accessories for the TC 3000/2 Toolcenter









Denomination	Explanation	Order no.
1 Rear wall TC 3000 RW	for Toolcenters TC 3000, TC 3000/2 incl. 10 hooks, dimensions length x width 990 x 340 mm, in carton	452986
2 Tool holder WHR/D-TC	for the TC 2000, TC 3000, TC 3000/2, for safe, ergonomic storage of two electric and air tools at the same time, in carton	493415
3 Hose holder TC-SH	for the TC 2000, TC 3000, TC 3000/2, for retrofitting TC 3000, in carton	487304
4 Service unit VE-TC 3000	for Toolcenter TC 2000, TC 3000, for compressed air supply to mobile dust extractors CT 22/33 and SR 151, SR 200 series dust extractors in LE design, in carton	454808

Accessories for SYSROCK BR 10, BR 10 DAB+ construction site radios



Denomination	Explanation	Order no.
1 Battery pack BP 18 Li 5,2 AS	with AIRSTREAM function, lithium-ion (Li-ion) replacement battery pack for all Festool 18 V cordless tools (except CXS/TXS, RTSC, DTSC, ETSC), tensioner 18 V, capacity 5,2 Ah, weight 0,7 kg, in self-service display pack	200181
Battery pack BP 18 Li 5,2 AS-ASI	Bluetooth lithium-ion (Li-ion) battery pack with AIRSTREAM function for all Festool 18 V cordless tools (except CXS/TXS, RTSC, DTSC, ETSC), Bluetooth enables the CLEANTEC mobile dust extractor to be started automatically when the cordless tool is switched on (use of the Bluetooth module at the free slot on the CLEANTEC mobile dust extractor is required), tensioner 18 V, capacity 5,2 Ah, weight 0,7 kg, in carton	202479
Battery pack BP 18 Li 6,2 AS-ASI	Bluetooth lithium-ion (Li-ion) battery pack with AIRSTREAM function for all Festool 18 V cordless tools (except CXS/TXS, RTSC, DTSC, ETSC), Bluetooth enables the CLEANTEC mobile dust extractor to be started automatically when the cordless tool is switched on (use of the Bluetooth module at the free slot on the CLEANTEC mobile dust extractor is required), tensioner 18 V, capacity 6,2 Ah, weight 0,7 kg, in carton	201797
Battery pack BP 18 Li 3,1 C	compact, lightweight design, lithium-ion (Li-ion) replacement battery pack for all Festool 18 V cordless tools (except TSC 55, CXS/TXS, RTSC, DTSC, ETSC), tensioner 18 V, capacity 3,1 Ah, weight 0,4 kg, in self-service display pack	201789
2 Rapid charger TCL 6 GB 240V	for all Li-ion battery packs (except for CXS/TXS), Lithium-ion (Li-ion) replacement charger for all 10,8 – 18 V battery packs, charging current 6 A, input voltage 220 – 240 V, weight 0,8 kg, in self-service display pack	201136
Rapid charger SCA 8 GB 240V8	for all Li-ion battery packs (except for CXS/TXS), with AIRSTREAM function, Lithium-ion (Li-ion) replacement charger for all 10,8 – 18 V battery packs, charging current 8 A, input voltage 220 – 240 V, weight 1,1 kg, in self-service display pack	200311
Battery and charging technology	from page 10	

Workplace organisation



System accessories

SYSTAINER T-LOC		Type	Order no.
	SYSTAINER T-LOC 1x cover for label field		
	dimensions [L x W x H] 396 x 296 x 105 mm, dimensions with adjustable legs [L x W x H] 396 x 296 x 112 mm, inner dimensions [L x W x H] 383 x 273 x 75 mm, weight 1,3 kg	SYS 1 TL	497563
	dimensions [L x W x H] 396 x 296 x 157,5 mm, dimensions with adjustable legs [L x W x H] 396 x 296 x 164,5 mm, inner dimensions [L x W x H] 383 x 267 x 127,5 mm, weight 1,5 kg	SYS 2 TL	497564
	dimensions [L x W x H] 396 x 296 x 210 mm, dimensions with adjustable legs [L x W x H] 396 x 296 x 217 mm, inner dimensions [L x W x H] 382 x 266 x 180 mm, weight 1,8 kg	SYS 3 TL	497565
	dimensions [L x W x H] 396 x 296 x 315 mm, dimensions with adjustable legs [L x W x H] 396 x 296 x 322 mm, inner dimensions [L x W x H] 382 x 266 x 285 mm, weight 2,1 kg	SYS 4 TL	497566
	dimensions [L x W x H] 396 x 296 x 420 mm, dimensions with adjustable legs [L x W x H] 396 x 296 x 427 mm, inner dimensions [L x W x H] 381 x 265 x 384 mm, weight 2,7 kg	SYS 5 TL	497567
MAXI-SYSTAINER		Type	Order no.
	MAXI-SYSTAINER to connect with SYS 1, SYS 2, SYS 3, SYS 4, SYS 5, SORTAINER		
	dimensions [L x W x H] 596 x 390 x 210 mm, inner dimensions [L x W x H] 545 x 330 x 168 mm, weight 4 kg	SYS MAXI	490701
	dimensions [L x W x H] 596 x 390 x 157,5 mm, inner dimensions [L x W x H] 545 x 330 x 124 mm, weight 3 kg	SYS MAXI 2	492582
MIDI-SYSTAINER T-LOC		Type	Order no.
	MIDI-SYSTAINER T-LOC can be connected to SYS T-LOC, for clear and structured arrangement of small parts, power tools, hand-held tools and accessories, dimensions [L x W x H] 496 x 296 x 210 mm, inner dimensions [L x W x H] 483 x 267 x 180 mm, weight 2 kg	SYS-MIDI 3 TL	499621
MINI-SYSTAINER T-LOC		Type	Order no.
	MINI-SYSTAINER T-LOC for clear and structured arrangement of small parts and hand-held tools, cannot be connected to SYS 1, SYS 2, SYS 3, SYS 4, SYS 5, SORTAINER, SYS MINI classic, can be combined with SYS-MINI 1 and 3 TL, weight 0,4 kg		
	dimensions [L x W x H] 265 x 171 x 71 mm, inner dimensions [L x W x H] 255 x 155 x 53 mm	SYS-MINI 1 TL	499622
	dimensions [L x W x H] 265 x 171 x 142 mm, inner dimensions [L x W x H] 255 x 155 x 124 mm	SYS-MINI 3 TL	202544





SYSTAINER T-LOC with lid compartment

	Type	Order no.
 <p>SYSTAINER T-LOC DF 1x cover for label field</p> <p>dimensions (L x W x H) 396 x 296 x 105 mm, dimensions with adjustable legs (L x W x H) 396 x 296 x 112 mm, inner dimensions (L x W x H) 383 x 273 x 68 mm, weight 1,5 kg</p>	SYS 1 TL-DF	497851
 <p>dimensions (L x W x H) 396 x 296 x 157,5 mm, dimensions with adjustable legs (L x W x H) 396 x 296 x 164,5 mm, inner dimensions (L x W x H) 383 x 267 x 121 mm, weight 1,7 kg</p>	SYS 2 TL-DF	497852
 <p>dimensions (L x W x H) 396 x 296 x 210 mm, dimensions with adjustable legs (L x W x H) 396 x 296 x 217 mm, inner dimensions (L x W x H) 382 x 266 x 173 mm, weight 2 kg</p>	SYS 3 TL-DF	498390

SYSTAINER T-LOC SYS-Combi

	Type	Order no.
 <p>SYSTAINER T-LOC flexibly divisible drawer for accessories, consumables, small parts and sundries, internal dimensions of the drawer (L x W x H) 350 x 255 x 69 mm</p> <p>combination of the classic SYSTAINER size 2 and a spacious drawer, dimensions (L x W x H) 396 x 296 x 263 mm, dimensions with adjustable legs (L x W x H) 396 x 296 x 270 mm, internal dimensions of the top compartment (L x W x H) 383 x 267 x 127 mm, weight 3,2 kg</p>	SYS-Combi 2	200117
 <p>combination of the classic SYSTAINER size 3 and a spacious drawer, dimensions (L x W x H) 396 x 296 x 315 mm, dimensions with adjustable legs (L x W x H) 396 x 296 x 322 mm, internal dimensions of the top compartment (L x W x H) 382 x 266 x 180 mm, weight 3,5 kg</p>	SYS-Combi 3	200118

SORTAINER



	Type	Order no.
 <p>SORTAINER 2 x small drawer (L x W x D) 255x75x30 mm, medium drawer (L x W x D) 255 x 165 x 30 mm, large drawer (L x W x D) 255 x 348 x 85 mm, 2 dividers per drawer, 6 x label holders, 8 x lettering strips, dimensions (L x W x H) 395 x 295 x 210 mm, weight 4 kg</p>	SYS 3-SORT/4	491522
 <p>6 x medium drawer (L x W x D) 255 x 165 x 30 mm, 2 dividers per drawer, 6 x label holders, 8 x lettering strips, dimensions (L x W x H) 395 x 295 x 210 mm, weight 4,9 kg</p>	SYS 3-SORT/6	491984
 <p>6 x small drawer (L x W x D) 255x75x30 mm, 3 x medium drawer (L x W x D) 255 x 165 x 30 mm, 2 dividers per drawer, 9 x label holders, 16 x lettering strips, dimensions (L x W x H) 395 x 295 x 210 mm, weight 5,1 kg</p>	SYS 3-SORT/9	491985
 <p>12 x small drawer (L x W x D) 255x75x30 mm, 2 dividers per drawer, 12 x label holders, 16 x lettering strips, dimensions (L x W x H) 395 x 295 x 210 mm, weight 5,3 kg</p>	SYS 3-SORT/12	491986
 <p>three drawers, each with a capacity of 6.7 litres, can be set up and divided individually with plastic containers and partitions (plastic containers and small partitions are not included), connects to all T-LOC and Classic Systainers, SORTAINERS and CLEANTEC mobile dust extractors, dimensions (L x W x H) 396 x 296 x 322 mm, weight 5,7 kg</p>	SYS 4 TL-SORT/3	200119

Workplace organisation



System accessories

SYS tool box		Type	Order no.
	<p>SYS tool box for practical transportation of hand tools, consumable materials and accessories, contact surface 396 x 296 mm</p> <p>dimensions [L x W x H] 396 x 296 x 150 mm, height 150 mm, load capacity 7 kg, volume 12,5 l</p>	SYS-TB-1	495024
	<p>dimensions [L x W x H] 396 x 296 x 257 mm, height 257 mm, load capacity 14 kg, volume 20 l</p>	SYS-TB-2	499550
SYS-StorageBox		Type	Order no.
	<p>SYS-StorageBox plastic container, no content, with individually removable plastic containers, can be connected to the entire Systainer range (except SYS-Mini), 2 x Box 60x60x71 SYS-SB, 2 x Box 60x120x71 SYS-SB, 1 x Box 180x120x71 SYS-SB, dimensions [L x W x H] 396 x 296 x 167 mm, height including handle 240 mm, weight 2,5 kg</p>	SYS-SB	499901
Systainer-Port		Type	Order no.
	<p>Systainer-Port no admission for assembly in car, stable full metal body, 5 x labels for drawers, with 3 SYSTAINER telescopic drawers, without SYSTAINER, dimensions [L x W x H] 400 x 500 x 500 mm, weight 19 kg, in carton</p>	SYS-PORT 500/2	491921
	<p>Systainer-Port no admission for assembly in car, stable full metal body, 5 x labels for drawers, with 5 SYSTAINER telescopic drawers, 4 ball bearing-mounted swivel castors (2 with locking brakes), without SYSTAINER, dimensions [L x W x H] 400 x 500 x 1.100 mm, weight 33 kg, in carton</p>	SYS-PORT 1000/2	491922
	<p>Set of castors for SYS port, for assembly on SYS-Port, diameter 75 mm, in carton</p>	SYS-PORT R/2	491932
	<p>Telescopic drawer in carton</p>	SYS-PORT/TA/2	491923
Systainer pull-out		Type	Order no.
	<p>Pull-out drawer for all Systainers (Classic and T-LOC), for constructing an individual shelf system, in 32 hole grid, dimensions [L x W x H] 425 x 376 x 57 mm, max. load 20 kg, in carton</p>	SYS-AZ	500692
	<p>qty. in pack 5 piece(s)</p>	SYS-AZ-Set	500767
	<p>Lock for SYS-AZ, simultaneous lock, for subsequent installation in the pull-out drawer SYS-AZ, locks the individual pull-out drawer on the side of the body (simultaneous), in carton</p>	S-AZ	500693

Means of transport for SYSTAINER









	Type	Order no.
 <p>SYS-Cart for easy transportation of SYSTAINER sizes 1-5 and SORTAINERS., robust handles, 4 steering rollers, 2 of which can be locked, bASE 360 x 520 mm, load capacity 100 kg, roll dia. 100 mm, weight 2,8 kg, in carton</p>	RB-SYS	495020
 <p>SYS roller transportation of SYS Classic and SYS T-LOC, extra large wheels (D 200 mm) for easy transportation up and down steps, rotating lockable front rollers – manoeuvre in all directions, incl. safety belt, dimensions (L x W x H) 440 x 600 x 1.100 mm, total load capacity 100 kg, drawer load capacity 5 kg, front roll dia. 75 mm, rear roll dia. 200 mm, weight 6,5 kg, in carton</p>	SYS-Roll 100	498660

SYSTAINER T-LOC with inlays for abrasives

	Type	Order no.
 <p>SYSTAINER T-LOC</p>		
with insert for abrasives Ø 125 mm, dimensions (L x W x H) 396 x 296 x 105 mm, number of compartments 5, SYSTAINER size SYS 1 T-LOC	SYS-STF D125	497685
with insert for abrasives 80x133 mm, dimensions (L x W x H) 396 x 296 x 105 mm, number of compartments 6, SYSTAINER size SYS 1 T-LOC	SYS-STF 80x133	497684
with insert for abrasives STF Delta 100x150, dimensions (L x W x H) 396 x 296 x 105 mm, number of compartments 5, SYSTAINER size SYS 1 T-LOC	SYS-STF Delta 100x150	497686
with insert for Ø 90 mm abrasives and 93V abrasives, dimensions (L x W x H) 396 x 296 x 105 mm, number of compartments 8, SYSTAINER size SYS 1 T-LOC	SYS-STF-D77/D90/93V	497687
 <p>with insert for abrasives Ø 150 mm, dimensions (L x W x H) 396 x 296 x 210 mm, number of compartments 10, SYSTAINER size SYS 3 T-LOC</p>	SYS-STF D150	497690
 <p>with insert for abrasive, dia. 225 mm, dimensions (L x W x H) 396 x 296 x 315 mm, number of compartments 3, SYSTAINER size SYS 4 T-LOC</p>	SYS-STF D225	497691

Workplace organisation

System accessories

SYSTAINER with universal insert		Type	Order no.
	SYSTAINER T-LOC with universal insert for sundries, dimensions (L x W x H) 396 x 296 x 105 mm, SYSTAINER size SYS 1 T-LOC	SYS 1 UNI	497692
	with single diced foam insert to produce an aperture of any desired shape, dimensions (L x W x H) 396 x 296 x 105 mm, inner dimensions (L x W x H) 383 x 273 x 75 mm, SYSTAINER size SYS 1 T-LOC	SYS 1 VARI	497693
	with double diced foam insert to produce an aperture of any desired shape, dimensions (L x W x H) 396 x 296 x 157,5 mm, inner dimensions (L x W x H) 383 x 267 x 127,5 mm, SYSTAINER size SYS 2 T-LOC	SYS 2 VARI	497696
	with foam insert, for safe storage of cutters D 8, D 12, dimensions (L x W x H) 396 x 296 x 105 mm, inner dimensions (L x W x H) 383 x 273 x 75 mm, SYSTAINER size SYS 1 T-LOC	SYS-OF D8/D12	497695
	with individual removable plastic containers, plastic container, no content, dimensions (L x W x H) 396 x 296 x 105 mm, SYSTAINER size SYS 1 T-LOC	SYS 1 BOX	497694
Plastic containers and inserts for SYS-StorageBox, SYS 1 BOX, SYS-Combi, SYS 4 TL-SORT/3			
Plastic containers			
	for SYS-Storage Box SYS-SB, qty. in pack: 6, dimensions (L x W x H) 60 x 60 x 71 mm, qty. in pack 6 piece(s), in carton	Box 60x60x71/6 SYS-SB	500066
	for SYS-Storage Box SYS-SB, qty. in pack: 4, dimensions (L x W x H) 60 x 120 x 71 mm, qty. in pack 4 piece(s), in carton	Box 60x120x71/4 SYS-SB	500067
	for SYS-Storage Box SYS-SB, qty. in pack: 2, dimensions (L x W x H) 180 x 120 x 71 mm, qty. in pack 2 piece(s), in carton	Box 180x120x71/2 SYS-SB	500068
	for SYS-Combi 2, SYS-Combi 3 and SYS 4 TL-SORT/3, plastic containers and compartment dividers for individual drawer partitions, 8 x box of plastic containers 60 x 60 x 71 mm, 4 x box of plastic containers 60 x 120 x 71 mm, 3 x compartment dividers, 2 x cover pads, in bag	Set 60x60/120x71 3xFT	201124

Plastic containers and inserts for SYS-StorageBox, SYS 1 BOX, SYS-Combi, SYS 4 TL-SORT/3

	Type	Order no.
	for SYS 1 T-LOC box, in carton Plastic containers red, boxes excl. content, for clear storage and organisation, dimensions (L x W x H) 49 x 49 x 71 mm, qty. in pack 12 piece(s)	Box 49x49/12 SYS1 TL 498038
	Plastic containers yellow, boxes excl. content, for clear storage and organisation, dimensions (L x W x H) 49 x 98 x 71 mm, qty. in pack 6 piece(s)	Box 49x98/6 SYS1 TL 498039
	Plastic containers blue, boxes excl. content, for clear storage and organisation, dimensions (L x W x H) 98 x 98 x 71 mm, qty. in pack 3 piece(s)	Box 98x98/3 SYS1 TL 498040
	Plastic containers green, boxes excl. content, for clear storage and organisation, dimensions (L x W x H) 98 x 147 x 71 mm, qty. in pack 2 piece(s)	Box 98x147/2 SYS1 TL 498041
	Plastic containers orange, boxes excl. content, for clear storage and organisation, dimensions (L x W x H) 49 x 245 x 71 mm, qty. in pack 2 piece(s)	Box 49x245/2 SYS1 TL 498042
	Deep-drawer insert for SYS 1 T-LOC box, insert for fixing and positioning boxes, plastic containers are not included in the scope of delivery, in carton	Box TZE-SYS 1 TL 498043

SYSTAINER T-LOC with insert for hand tools

	Type	Order no.
	SYSTAINER T-LOC the required tool can be found quickly since all hand tools are clearly displayed for the joiner, items included without tools, wooden insert, installation recommendations, dimensions (L x W x H) 396 x 296 x 315 mm, inner dimensions (L x W x H) 382 x 266 x 285 mm, SYSTAINER size SYS 4 T-LOC	SYS-HWZ 497658

SYSTAINER T-LOC SYS-MFT

	Type	Order no.
	SYSTAINER T-LOC 1x cover for label field, can be connected to the entire Systainer range (except SYS-MINI), simple, compact transportation, cover with MDF board for clamping and fixing workpieces, dimensions (L x W x H) 396 x 296 x 105 mm, dimensions with adjustable legs (L x W x H) 396 x 296 x 112 mm, inner dimensions (L x W x H) 383 x 273 x 75 mm, weight 2 kg	SYS-MFT 500076

Hole drilling set

	Type	Order no.
	Hole drilling set for OF 900, OF 1000, OF 1010, OF 1400, for use with hole line guide rails, guide plate, centring mandrel, operation tool, hinge location cutter HM Ø 35 mm, dowel drill HW Ø 5 mm (V-shaped tip), dowel drill HM Ø 5 mm (with centring bit and pre-cutter), 2 parallel side fences with adjustable stop, clamp FSZ 120, 2 x Longitudinal stop, in SYSTAINER SYS 1 T-LOC	LR 32-SYS 584100



Workplace organisation

System accessories

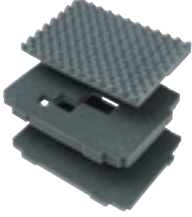
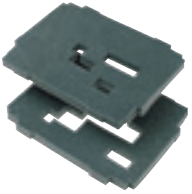

Foam inserts for SYSTAINER

		Type	Order no.
	Foam insert for SYS 1-5 T-LOC, dimpled insert (for lid), base insert and diced insert, qty. in pack 3 piece(s), in bag	SYS-VARI SE TL	497877
	Diced foam insert set for SYS 1-5 T-LOC, diced sections can be pushed out to produce any desired aperture, qty. in pack 2 piece(s), in bag	SYS-VARI RM TL	497878

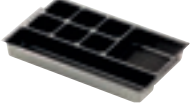

Lids and bottoms for Systainers

		Type	Order no.
	Cover pad in bag for SYS 1-5 T-LOC, with knobs, dimensions (L x W x H) 355 x 245 x 30 mm	SE-DP SYS 1-5 TL	498044
	for SYS MAXI, with knobs, dimensions (L x W x H) 560 x 340 x 30 mm	SE-DP SYS-MAXI	491633
	for SYS MIDI 3 TL, dimensions (L x W x H) 472 x 247 x 30 mm	SE-DP SYS-MIDI	499617
	for SYS MINI TL, dimensions (L x W x H) 247 x 134 x 15 mm	SE-DP SYS-MINI TL	499619
	Base pad in bag for SYS 1-5 T-LOC, protects the content	SE-BP SYS 1-5 TL	498045
	for SYS MAXI	SE-BP SYS-MAXI	491632
	for SYS MIDI 3 TL, dimensions (L x W x H) 480 x 278 x 30 mm	SE-BP SYS-MIDI	499618





Inlays and inserts for SYSTAINER

		Type	Order no.
	Multi-purpose insert for SYS MINI TL, dimensions (L x W x H) 258 x 163 x 45 mm, in bag	TZE-UNI SYS MINI TL	499620
	Cartridge inlay for SYS 5 T-LOC, to store cartridges, height 130 mm, in carton	TZE-KT SYS 5 TL	497876

Other accessories

	Type	Order no.
 <p>Additional hand grip for carrying SYS 1 T-LOC and SYS 2 T-LOC upright, in self-service display pack</p>	ZSG -Sys 1/2 TL	497856
 <p>Shoulder strap for CT-SYS and all SYSTAINERS T-LOC, easy transport of the CTL SYS and the SYSTAINER T-LOC, max. load 20 kg, qty. in pack 1 piece(s), in self-service display pack</p>	SYS-TG	500532
 <p>Cover cover for labelling panels SYS T-LOC, protects the labelling panels on the SYSTAINER T-LOC from damage and moisture, qty. in pack 10 piece(s), in self-service display pack</p>	AB-BF SYS TL 55x85mm /10	497855

plug it accessories

	Type	Order no.
 <p>plug it-cable in self-service display pack</p>		
rubber insulated cable 240V plug it, length 4 m	H05 RN-F/4 not available in Great Britain	489421
plug it-cable, length 4 m GB	H 05 RN-F 2x1,0	490650
 <p>for PLANEX, PLANEX easy long-reach sanders, rubber insulated cable 240V plug it, particularly suitable for use with the PLANEX LHS 225 thanks to extended cable bushing, for example for sanding work in dry construction, length 4 m</p>	H05 RN-F/4 EU PLANEX	499822
rubber insulated cable 240V plug it, length 5,5 m	H05 RN-F/5,5	201881
 <p>rubber insulated cable 240V plug it, length 7,5 m</p>	H05 RN-F/7,5 not available in Great Britain	489661
rubber insulated cable 240V plug it, length 10 m	H05 RN-F/10	500947
 <p>green rubber-insulated cable, length 4 m</p>	H05 BQ-F/4	489662
green rubber-insulated cable, length 7,5 m	H05 BQ-F/7,5 not available in Great Britain	489663
 <p>plug it conversion-kit in self-service display pack</p>		
For RS1, RS 1 C, DX 93, R0 150/R02, RAS 115, BF 1, PS 200/PS/2, KF 4, length 360 mm	UBS-PUR 360 plug it 240 V not available in Great Britain	491144
For RS 2, RS 3, RS 400/RS 4, DS 400, ES 125, OF 1000, OF 900, ATF 55, AT 65, AP 55, AP 65, EHL 65, length 420 mm	UBS-PUR 420 plug it 240 V not available in Great Britain	491145



Hoodie

Festool hoodie for genuine fans.

Hood with drawstrings in green. Brushed inside and kangaroo pocket on the front, stitched waistband and cuffs.

Colouring: Dark blue with Festool Fan printed on the left-hand side of the chest and on the back.

Material: 60% cotton, 40% polyester

Produced in accordance with the OEKO-TEX® standard.

Sizes	Order no.
XS	202849
S	201300
M	201301
L	201302
XL	201303
XXL	201304



Knitted hat

For cold days.

Breathable with excellent insulating properties.

Material: 100% acrylic.

Produced in accordance with the OEKO-TEX® standard.

Sizes	Order no.
One size	202308

Softshell jacket

Breathable, windproof and water-resistant.

Two hip pockets and one chest pocket, all with a zip fastener.

Green decorative stitching and green 3D Festool logo on the left upper arm. Removable hood.

Outer material: 93% polyester, 7% Spantex

Inner material: 100% polyester microfleece

Produced in accordance with the OEKO-TEX® standard.

Sizes	Order no.
S	201321
M	201322
L	201323
XL	201324
XXL	201325
XXXL	201326



Tape measure

In handy pocket size.

Practical 3 m long tape measure showing centimetres and inches. With an extendable compass needle to scribe a circle.

Material: Housing made of plastic, tape measure made of metal.

Sizes	Order no.
3 m	495415



Toolie multi function tool

Practical hexagon spherical head tool for almost every screwing situation.

There are nine hexagon socket wrenches with MagicRing in the sturdy and ergonomically designed housing, which can be selected and folded out simply using an eject button.

Sizes	Order no.
12 cm long	498863



Safety cutter knife

For the perfect cut.

Safety box cutter with automatic blade retraction when not in use. Equally suitable for left- and right-handed users. With a napped soft grip for good handling and a secure hold.

Blade width: 18 mm

Blade length: 60 mm

Sizes	Order no.
12 cm long	498183

More products from our current collection can be found on:
www.festool.co.uk



Crew neck t-shirt

The Festool classic.

Festool logo at the front on the chest.
 Material: 100% cotton.
 Produced in accordance with the OEKO-TEX® standard.

Sizes	Order no.
S	497912
M	497913
L	497914
XL	497915
XXL	497916



Golf cap

The sporty all-rounder.

Cap with Festool and www.festool.com embroidery. Curved visor with green stripe. Width adjustment at the back for an optimum fit.
 Material: Denim.

Sizes	Order no.
One size	497899

Babygrow

For Festool's youngest fans.

Babygrow in blue, Festool Fan logo on the chest, short sleeves and crew neck collar. Three green snap fasteners in the crotch.
 Material: 100% organic cotton.
 Produced in accordance with the OEKO-TEX® standard.



Sizes	Order no.
68	202307



Notebook

Nothing is lost here.

Large hardcover notebook. 200 squared, tear-off pages, including bookmark.

Sizes	Order no.
DIN A4	498866



uvex

Safety goggles

Original UVEX safety goggles uvex i-vo.

Optimum wear comfort thanks to duo-component technology: Soft components in sensitive areas (nose, forehead and ears) prevent pressure points. Quattroflex legs with bend and length adjustment. Lenses: Scratch-resistant on the outside, anti-fog on the inside. Colourless/UV 2-1.2, supravision HC-AF coating. Lenses can be replaced easily. Colouring: Frame colour blue/green, with Festool logo.

Sizes	Order no.
One size	500119



Sports bag

Ideal for carrying en route.

Sturdy sport bag with green decorative stitching and embossed logo on the side pocket. Large main compartment, inside compartment with Velcro fastening and separate compartment for wet items. Extra-reinforced base and sewn-on plastic pyramid feet for even more stability. Adjustable carrying strap, black side pocket with embossed logo.
 Volume: Approx. 45 l

Sizes	Order no.
50 x 30 x 30 cm	498494

- 18-volt system
 Overview of batteries and chargers 10-11
 Overview of products 8-9
 3.1 Ah Compact battery pack 10
 5.2 Ah AIRSTREAM battery pack 10
 5.2 Ah AIRSTREAM Bluetooth battery pack 10
 6.2 Ah AIRSTREAM Bluetooth battery pack 11
- A**
- A helping hand 402
 Abrasive pad 167
 Abrasive paper 167
 Abrasive paper holder
 For EAA 417
 Abrasive roll 166-167
 Abrasive sheet 344
 Abrasive sponge 167
 Abrasives
 Brilliant 2 151, 153-154, 156, 158,
 160-161, 163-164, 166
 Cloth 151, 156, 158, 161, 167
 For CONTURO 344
 Granat 151-153, 155, 157, 159-164, 166-167
 Granat Net 151, 155, 157, 159-160, 162
 Granat soft 166
 Hand abrasives 166-167
 Overview 150-151
 Platin 2 151, 153, 156, 158
 Rubin 2 151-155, 157, 159, 161-164
 Saphir 151, 154, 156, 158-160, 165
 Absolute filter 212-213
 Accessories for CT mobile dust
 extractors 207-211
 Accessories for CT mobile dust extractors
 and SR dust extractors 201-208, 212, 214
 Accessories set
 For FS/2 418
 For routers 269
 Accessories SYS ZH-SYS-PS 420 62
 Accessories SYSTAINER
 For VAC SYS 416
 Adapter
 For FS/2 and GECKO 418
 For IAS 3 hoses 146-147
 For routers 269
 For stirrers and drills 234, 236, 239, 350, 359
 For SYSLITE STL 450 and tripod ST DUO 391
 For the Workcenter 214
 For VAC SYS and MFT 3 415-416
 Adapter hose
 For CS, CMS, flush-mounted trimming
 saws 203, 414
 Adapter plate
 AP-KA 65 341
 For sliding compound mitre saws 68
 Adapter ring for stirrer stand
 For stirrers 359
 Adapter table
 For pendulum jigsaws 62, 396, 419
 Additional clamp 415
 Additional hand grip
 For PLANEX 143
 For POLLUX 170
 For RAS 180 142
 For ROTEX RO 150 136
 For SHINEX 170
 For SYSTAINERS 429
- Additional roll 344
 Additional stop
 For compound mitre saws 70
 For DOMINO joining machines 329
 Adhesive 345
 Adhesive cushion strip
 For FS/2 418
 Adjustable stop
 For CS 50, CS 70 414
 For routers 273
 For the MFT/3 415
 For trimming saws 69, 71-72
 All-round extractor 180, 190
 Aluminium composite milling machine
 PF 1200 247, 262, 275
 Aluminium cutter 299
 Anchor bolt
 For the DOMINO joining system 332-333
 Angle arm
 For routers 273
 Angle attachment 232-233, 235
 Angle chuck 236
 Angle stop
 For carpentry circular saws 67
 For CS 414
 For FS/2 418
 For planers 318
 For trimming saws 71-72
 Angle table
 For pendulum jigsaws 62
 Antistatic connector sleeve 205
 Antistatic rotating adapter 204
 Antistatic rotating angle adapter 204
 APS 255
 APS worktop template 255, 271
 ASA 403, 417
 Asbestos 181, 197
 Assembly package 239
 Assembly set 215
 ATEX 181, 196
 AUTOCLEAN 181, 183, 192-194
 AUTOCLEAN automatic main filter cleaning 183
 Auxiliary handle
 For BHC 234
 For DSC-AG 125 382
 For QUADRILL DR 20 236
 For QUADRIVE DRC 18/4,
 QUADRIVE PDC 18/4 235
- B**
- Babygrow 431
 Bag
 For FS/2 419
 For FSK 65-66
 For PLANEX 143
 Balancer 381
 Ball bearing guide 294-296, 299-302, 304-307
 Base pad
 For SYSTAINERS 428
 Base runner
 For pendulum jigsaws 62
 For routers 267-269
 Basic unit CMS GE 397, 414
 Basin cutter 305
 Battery 10-11, 63-65, 232-235, 237
 Battery and charging technology 10
 Battery charger
 SCA 8 11
 TCL 6 11
 Battery pack 10-11, 63-65, 232-235, 237, 391
 BP 18 Li 3.1 C 421
 BP 18 Li 3.1 Ergo 137, 140
 BP 18 Li 5.2 AS 421
 BP 18 Li 5.2 AS-ASI 421
 BP 18 Li 6.2 AS-ASI 421
 Battery pack lifetime 10
 Battery sets 12
 Beech dowel 328-332
 Belt sander
 BS 75 93, 117, 144
 BS 105 93, 118, 144
 Belt sander module
 CMS-BS 93, 119, 144
 Bench saw 33, 53-54, 71-72
 Bench saw CMS-TS 55 R Set 43, 397
 Bench saw module CMS-TS 30, 43, 396-397
 Bench unit
 For belt sanders 144
 For edge banders 341
 Bench-mounted routers
 TF 1400 246, 253
 TF 2200 246, 253
 Bevel
 For sliding compound mitre saws 68-69
 BHC 18 19, 219, 223, 234
 BHC 18 cordless hammer drill 19, 219, 223, 234
 Bi-metal saw blade for metal
 For oscillators 85
 Bi-metal universal saw blade
 For oscillators 85
 Bit box 239
 Bit cassette 239
 Bit holder 237, 239
 Bits
 Length 25 mm 238
 Length 100 mm 238
 PZ, TX 237-238
 Blade
 For sword saws 73
 Blanking plug 205
 Bluetooth battery pack 10-11, 184
 Bluetooth technology 10-11, 183
 BMS 180 93, 131, 149
 Body 431
 Boom arm ASA 403, 417
 Box cutter 430
 BP 18 Li 3.1 C 421
 BP 18 Li 5.2 AS 421
 BP 18 Li 5.2 AS-ASI 421
 BP 18 Li 6.2 AS-ASI 421
 BR 10 25, 408, 421
 BR 10 DAB+ 25, 408, 421
 Brilliant 2 151, 153-154, 156, 158,
 160-161, 163-164, 166
 Brush ring
 For DSG-AG 125 379
 For RG 130 378
 For RG 150 381
 Brush segment
 For PLANEX 143
 Brush strip
 For PLANEX 143
 Brushing machine 93, 131, 149
 BS 75 93, 117, 144
 BS 105 93, 118, 144

- C**
- C 18 17, 218, 221, 233
- Cable holder 183
- Cap 431
- Carpentry planer 310, 315, 319
- Carpet nozzle 207
- Carpet remover blade 383
- Carpet remover TPE-RS 100 365, 374, 383
- Carpet scraper 383
- Carrying harness
For PLANEX 143
- Cartridge inlay
For SYSTAINERS 428
- CARVEX PS 420 28, 36, 62-63
- CARVEX PSB 420 28, 36, 62-63
- CARVEX PSBC 420 14, 29, 38, 62-63
- CARVEX PSC 420 14, 29, 37, 62-63
- Ceiling suspension
For EAA 417
- Centring bit 242
- Centring mandrel
For routers 266
- CENTROTEC Forstner drill bit, ZOBO system 242
- CENTROTEC HSS twist drill bit 240
- CENTROTEC tool chuck 232-236
- CENTROTEC tools for drilling and countersinking 242
- Chain cutter
For chain mortisers 276
- Chain lubrication oil
For sword saws 73
- Chainsaw chain
For sword saws 73
- Chamfer cutter 287, 300, 302, 304
- Charger
SCA 8 11, 232-235, 237, 421
TCL 6 11, 232-235, 237, 421
- Chip collection bag
For circular saws 64, 65
For planers 318
- Chip deflector
For routers 267-268, 270
- Chip guard
For routers 273
- Chuck 228, 232-233, 235
- Circular plunge cut saw 15, 30, 41, 64
- Circular saw 16, 31, 44, 46, 48, 65-67
HK 55 31, 44, 65
HK 85 31, 46, 66
TS 55 R 30, 40, 64
TS 75 30, 42, 64
- Clamping kit
For sliding compound mitre saws 68-69
- Clamping nut
For DSC-AG 125 382
For DSC-AG 230 382
For DSG-AG 125 379
For RG 130 378
- Cleaner 345
- Cleaning 181, 183, 192-194
- Cleaning and lubricating oil
For compressed air eccentric sanders 146-147
- Cleaning cloth 171, 177
- Cleaning set 200
- Cleaning set for industrial use 200
- Cleaning set for the workshop 200
- Cleaning set for tradesmen 200
- CLEANTEC
Cleaning sets 200
CT 17 180, 186
CTH 26 181, 197
CTH 48 181, 197
CTL 26 180, 190
CTL 26 AC 181, 192
CTL 26 AC HD 181, 194
CTL 36 180, 190
CTL 36 AC 181, 192
CTL 36 AC HD 181, 194
CTL 36 AC PLANEX 181, 193
CTL 48 181, 191
CTL 48 AC 181, 192
CTL 48 EC 181, 195
CTL 48 EC/B22 181, 196
CTL MIDI 180, 189
CTL MINI 180, 188
CTM 26 180, 190
CTM 26 AC 181, 192
CTM 36 180, 190
CTM 36 AC 181, 192
CTM 36 AC HD 181, 194
CTM 36 AC PLANEX 181, 193
CTM 48 181, 191
CTM 48 AC 181, 192
CTM 48 EC 181, 195
CTM 48 EC/B22 181, 196
Filter 209
Filter bags 210
Hose sleeves 204
Sleeve 183
Suction hose 203
Suction hose, antistatic version 201-202
- CLEANTEC mobile dust extractor
compact 180, 186
CT 17 180, 186
CTH 26 181, 197
CTH 48 181, 197
CTL 26 180, 190
CTL 26 AC 181, 192
CTL 26 AC HD 181, 194
CTL 36 180, 190
CTL 36 AC 181, 192
CTL 36 AC HD 181, 194
CTL 36 AC PLANEX 181, 193
CTL 48 181, 191
CTL 48 AC 181, 192
CTL 48 EC 181, 195
CTL 48 EC/B22 181, 196
CTL MIDI 180, 189
CTL MINI 180, 188
CTM 26 180, 190
CTM 26 AC 181, 192
CTM 36 180, 190
CTM 36 AC 181, 192
CTM 36 AC HD 181, 194
CTM 36 AC PLANEX 181, 193
CTM 48 181, 191
CTM 48 AC 181, 192
CTM 48 EC 181, 195
CTM 48 EC/B22 181, 196
Cloth 151, 156, 158, 161, 167
CM 150 247, 263, 276
CM 150 chain mortiser 247, 263, 276
CMS 396, 414
CMS basic unit 397, 414
CMS module mounting TS 30, 43, 396-397
CMS-BS 93, 119, 144
CMS-GE 397, 414
CMS-MOD BS 120 119, 396
- CMS-MOD-TS 55 R 43, 396
CMS-MOD-TS 75 43, 396
CMS-OF 252, 396
CMS-PS 29, 39, 396-397
CMS-PS jigsaw blade module 29, 39, 396-397
CMS-TS 30, 43, 396-397
CMS-TS 55 R 43, 396
CMS-TS 75 43, 396
- Collets
For edge routers 274
For module edge routers 274
For routers 266, 268, 270
- Combination bevel 418
- COMPACT 12
- Compact cleaning set 200
- Compact extractor 180, 188-189
- Compact Module System 396, 414
- Compound and mitre saws 32, 49-51, 68-69
- Compound mitre saw 32, 49-51, 68-69
- Compound mitre saw
SYMMETRIC SYM 70 32, 52, 70
- Compressed air eccentric sander
LEX 3 77 94, 121, 145-146
LEX 3 125 94, 122, 145-146
LEX 3 150 94, 123, 145-146
- Compressed air hose
For compressed air eccentric sanders 146-148
- Compressed air module 208, 215
- Compressed air orbital sander
LRS 93 95, 124, 147
LRS 400 95, 125, 147
- Compressed air orbital sanders 95, 124, 147
- Compressed air sander 120
- Compressed air service unit 215
- Concrete sander 362, 367-368, 378-379
- Connecting piece
For FS/2 419
For guide rails 275
For the MFT/3 415
- Connecting router
DF 500 322, 324, 328-329
DF 700 322, 325, 330-333
- Connecting sleeve
For IAS 3 hoses 146-147
- Connecting worktops
For routers 271
- Connection fitting 332-333
- Connector range 333
- Connector set 332-333
- Construction cleaning set 200
- CONTURO KA 65 336, 338, 344-345
- Copier scanning set
For routers 273
- Copying rings
For routers 266, 268-269
- Cordless circular saw 16, 31, 44, 46, 65-66
- Cordless delta sander
DTSC 400 88, 112, 140
- Cordless drill 17-18, 20-21, 218-222, 224-225, 232-233, 235
- Cordless drill
C 18 17, 218, 221, 233
CXS 218, 220, 232
DRC 18/4 20, 219, 224, 235
T 18+3 18, 218, 222, 233
TXS 218, 220, 232
- Cordless eccentric sander
ETSC 125 88, 101, 137
- Cordless jigsaw 14, 29, 38, 62-63

- Cordless orbital sander
RTSC 400 88, 110, 140
- Cordless pendulum cover
saws 16, 31, 44, 46, 65-66
- Cordless pendulum jigsaw
CARVEX PSBC 420 14, 29, 38, 62-63
CARVEX PSC 420 14, 29, 37, 62-63
- Cordless plunge-cut circular saw 15, 30, 41, 64
- Core maker
For pendulum jigsaws 62
- Corner and surface connector
For the DOMINO joining system 332-333
- Corner connector
For the DOMINO joining system 332-333
- Counterprofile cutter 296
- Cover
For circular saws 64
For labelling panels on SYSTAINERS 429
- Cover cap
For the DOMINO joining system 332-333
- Cover pad
For SYSTAINERS 428
- Crevice nozzle 207
- Crew neck t-shirt 431
- Cross anchor
For the DOMINO joining system 332-333
- Cross brace 415
- Cross stop
For DOMINO joining machines 329, 331
- Cross-cut tooth saw blade 75
- Crossheaded guide 345
- Crown stop
For sliding compound mitre saws 69
- CS 50 33, 53, 71
CS 70 33, 54, 72
CS 70 transport rollers 72
- CT 17 180, 186
CT accessories 214
CT boom arm 208
CT compressed air accessories 215
CT SYS mobile dust extractor 180, 187
CT WINGS 402
- CTH 26 181, 197
CTH 48 181, 197
CTL 26 180, 190
CTL 26 AC 181, 192
CTL 26 AC HD 181, 194
CTL 36 180, 190
CTL 36 AC 181, 192
CTL 36 AC HD 181, 194
CTL 36 AC PLANEX 181, 193
CTL 48 181, 191
CTL 48 AC 181, 192
CTL 48 EC 181, 195
CTL 48 EC/B22 181, 196
CTL MIDI 180, 189
CTL MINI 180, 188
CTL SYS 180, 187
CTL SYS SYSTAINER extractor 180, 187
- CTM 26 180, 190
CTM 26 AC 181, 192
CTM 36 180, 190
CTM 36 AC 181, 192
CTM 36 AC HD 181, 194
CTM 36 AC PLANEX 181, 193
CTM 48 181, 191
CTM 48 AC 181, 192
CTM 48 EC 181, 195
CTM 48 EC/B22 181, 196
- Curved saw blade
For pendulum jigsaws 78-79
- Cushioning
For ROTEX 134-136
- Cutter spindle
For CMS-OF 414
For disc groove cutters 294
- Cutter wheel
For RG 80 380
For RG 150 381
- Cutters 278
- Cutting chains
For chain mortisers 276
- Cutting parallel grooves
For module edge routers 274
For routers 266-270
- CXS 218, 220, 232
- ## D
- Deburring countersink 242
- Deep-drawer insert
For SYSTAINERS 427
- Deflector
For FS/2 419
- Delta sander
DTS 400 R 91, 111, 140
DTSC 400 88, 112, 140
- Delta sanding pad
For orbital sander RUTSCHER 139-140, 147
- Depth gauge ring 362-363, 378-381
- Depth limiter 362-363, 378-381
- Depth stop 233, 235
- Depth stop set OS-TA Set
For oscillators 84
- DF 500 322, 324, 328-329
DF 700 322, 325, 330-333
- DIA ABRASIVE 362-363, 378-381
DIA HARD 362-363, 378-381
DIA STONE 362-363, 378-381
DIA THERMO 362-363, 378, 379
DIA UNI 362-363, 378-381
- Diamond cutting system
DSC-AG 125 364, 371, 382
DSC-AG 125 FH 364, 372, 382
DSC-AG 230 364, 373, 382
- Diamond disc
DIA ABRASIVE 362-363, 378-381
DIA HARD 362-363, 378-381
DIA STONE 362-363, 378-379
DIA THERMO 362-363, 378-381
DIA UNI 362-363, 378-381
For DSC-AG 125 382
For DSC-AG 125 FH 382
For DSC-AG 230 382
For DSG-AG 125 379
For RG 80 380
For RG 130 378
For RG 150 381
- Diamond grinding system
DSG-AG 125 362, 368, 379
- Diamond saw blade
For circular saws 82-83
- Directly driven orbital sander RUTSCHER
RS 200 90, 107, 139
RS 300 90, 108, 139
RTS 400 R 90, 109, 140
- Dirt trap 214
- Disc groove cutter 294
- Disc stirrer 357
- Disposable bag 210, 213
- DOMINO
Connector range 333
Corner and surface connector 332-333
DF 500 322, 324, 328-329
DF 700 322, 325, 330-333
Dowel range 329, 331
Dowels 328-332
Empty SYSTAINER 331
Router 328, 330
Stops 328-331
- DOMINO joining machine
DF 500 322, 324, 328-329
DF 700 322, 325, 330-333
- Double-headed bolt
For the DOMINO joining system 332-333
- Dovetail cutter
For routers 272, 291
- Dovetail joint template
For routers 272
- Dowel drill
For routers 272, 295
- Dowel joint
For routers 272
- Dowel pin
For DOMINO joining machines 329, 331
- Dowel range
For DOMINO joining machines 329, 331
- Dowels
For DOMINO joining machines 328-332
- DR 20 219, 226, 236
DRC 18/4 20, 219, 224, 235
- Drill 219, 226, 236
- Drill adapter 242
Drill bit 241
Drill bit box for HSS steel drill bits 240
Drill bit case 241
Drill countersink with depth stop 234, 242
Drill stand for carpentry 243
- Drilling and screwdriving
Accessories and consumable materials 230-243
Overview of products and applications 218-219
- Drilling cutter 290
- Drilling dust nozzle 234
- Dry construction sanders 92, 115, 143
- Drywall screws 243
- DSC-AG 125 364, 371, 382
DSC-AG 125 FH 364, 372, 382
DSC-AG 230 364, 373, 382
DSG-AG 125 362, 368, 379
- DTS 400 R 91, 111, 140
DTSC 400 88, 112, 140
- Duo stirrers
MX 1600/2 DUO 349, 353
- DUPLEX LS 130 91, 113, 141
- DURADRIVE
DWC 18-2500 22, 219, 227, 237
DWC 18-4500 22, 219, 227, 237
- DURADRIVE cordless drywall screwdriver
DWC 18-2500 22, 219, 227, 237
DWC 18-4500 22, 219, 227, 237
- Dust bag
For belt sanders 144
- Dust categories in accordance with
EN 60335-2-69 182
- Dust container 214

Dust extraction
 Accessories and consumable materials 200-215
 For routing 251
 Overview of products and applications. 180-181
 Dust extraction attachment
 For DSC-AG 230 382
 For DSG-AG 125 379, 382
 For routers 267-268
 Dust extraction set CS 70 71-72, 414
 Dust extractor 180, 187
 DWC 18-2500 22, 219, 227, 237
 DWC 18-4500 22, 219, 227, 237

E

EAA CT/SR 404, 417
 EAA CT/SR energy boxes 404, 417
 EC eccentric sander 89, 102, 104, 137-138
 Eccentric adapter 233
 Eccentric sander
 ETS 125 R 89, 100, 137
 ETS 150 89, 103, 138
 ETS EC 125 89, 102, 137
 ETS EC 150 89, 104, 138
 ETSC 125 88, 101, 137
 Edge bander
 CONTURO KA 65 334-345
 Edge routers
 OFK 500 247, 259, 274
 OFK 700 247, 260, 274
 Edge trimming cutter 290
 Edge trimming set 345
 Edge trimming system OF-FH 2200 258, 273
 Edging 334-345
 Accessories and consumable materials 342-345
 Overview of products and applications 336
 Edging plate
 For routers 273
 Efficient dust extraction
 For routers 266-270
 EHL 65 EQ 310, 312, 318
 Electric planers
 EHL 65 EQ 310, 312, 318
 HL 850 310, 313, 318
 Electrical outlet module 208
 Energy box 417
 Energy box module
 For connection to the CT mobile dust extractor 208, 417
 ErgoFix adapter
 For stirrers 350, 359
 ErgoFix height adjustment
 For stirrers 350
 ErgoFix quick-change system 350
 ETS 125 R 89, 100, 137
 ETS 150 89, 103, 138
 ETS EC 125 89, 102, 137
 ETS EC 150 89, 104, 138
 ETSC 125 88, 101, 137
 EVA adhesive
 Black 345
 Brown 345
 Natural 345
 White 345
 Extension handle 383
 Extension pipe 206

Extension profile
 For routers 271
 Extension table (length)
 For the CMS basic unit 414
 Extension table (width)
 For routers 267
 For the CMS basic unit 414
 For trimming saws 71-72
 For cross anchor 332-333
 For trimming saws 71
 Extraction adapter
 For belt sanders 144
 For suction hose D 50 205

F

Facing cutter 297-298
 Fan shop 430-431
 Fastening clamp
 For FS/2 418
 For routing 275
 For sliding compound mitre saws 68
 For the MFT/3 415
 FastFix
 For changing cutters 251
 FastFix louvre pad
 For ROTEX 135
 FastFix polishing pad
 For ROTEX 134-136
 FastFix quick-change system
 For stirrers 350
 FastFix sanding pad
 For ROTEX 134-136
 Feather key
 For the Workcenter and Universalcenter 420
 Feeler rollers
 For aluminium composite milling machines 275
 Felt 344
 Felt for hand-sanding block 344
 Felt pad 344
 Filter bag 210-213
 Filter bags for discontinued models 213
 Filter element 209
 Fine adjuster for parallel side fence
 For routers 266-267
 Fine tooth saw blade
 For circular saws 80-81
 Fine-cut saw blade
 For pendulum jigsaws 76-77
 Finish cleaner 171
 Fixed clamps 415
 Fixed rod for stirrer stand
 For stirrers 359
 Flange
 For DSC-AG 125 379, 382
 For DSC-AG 230 382
 Flat connectors
 For the DOMINO joining system 332-333
 Flat nozzle 207
 Flat sanding pad
 For DUPLEX 141
 Flat tooth saw blade
 For circular saws 75, 82-83
 Flies 344
 Floor cleaning set 200
 Floor guide 381
 Floor nozzle 206

Flush trim cutter 289, 300, 302, 307
 Flush-mounted trimming saw 33, 53-54, 71-72
 Flute cutter 288
 Flute profile sanding pad
 For DUPLEX 141
 Foam inserts
 For SYSTAINERS 428
 Foldaway legs
 For trimming saws 71
 Foot valve
 For VAC SYS 416
 Forstner drill bit, ZOBO system 242
 FS/2 400, 418-419
 FSK cross cutting guide rail 47, 65-66

G

Geared orbital sanders RUTSCHER
 RS 100 90, 106, 139
 GECKO 401
 GECKO dual suction pad 401
 General information 442
 Golf cap 431
 Granat 151-153, 155, 157, 159-164, 166-167
 Granat Net 151, 155, 157, 159-160, 162
 Granat soft 166
 Groove cutter
 For routers 271, 280-281
 Groove unit
 For circular saws 66
 Guard
 For CMS-OF 414
 Guard ring 235
 Guide control black powder
 For sanders 146
 Guide extension
 For FS/2 419
 For PLANEX 143
 For stirrers 359
 For the MFT/3 415
 Guide frame
 For chain mortisers 276
 Guide piece 345
 Guide plate
 For routers 273
 Guide rail
 For carpentry circular saws 67
 For routing 251, 273
 FS/2 400, 418-419
 Guide rail adapter
 For FS/2 419
 For pendulum jigsaws 62
 For routers 267-269
 Guide rods
 For routers 266, 269
 Guide strip 345
 Guide table 362-363, 378-381

H

Half-round cutter 285
 Hammer drill 235
 Hammer drill 19, 219, 223, 234
 Hand abrasives 166-167
 Hand grip cutter 291
 Hand rail cutter 291
 Hand rail cutter 299
 Hand tube 206

- Hand-held planer
 PL 205 310, 315, 319
 PL 245 310, 315, 319
- Handle 214
 For ROTEX RO 150 136
- Handrail fence
 For DOMINO joining machines 329, 331
- Hand-sanding block 149, 344
- Hard fibre base runner
 For routers 267
- Harmful substance extractor 181, 197
- Hexagon spherical head tool 430
- Hinge location cutter
 For routing 294
- HK 55 31, 44, 65
 HK 132 carpentry circular saw 31, 48, 67
 HK 85 31, 46, 66
 HK 132 31, 48, 67
 HKC 55 16, 31, 44, 65
 HKC 55 cordless circular saw 16, 31, 44, 65
 HL 850 310, 313, 318
- Holder for spray gun
 For Workcenter 420
- Hole drilling set
 For routers 273
 LR 32-SYS 427
- Hole punch
 For orbital sander RUTSCHER 139
- Hole series set
 For routers 273
- Hole series system
 For FS/2 257
 LR 32 257, 273
- Hoodie 430
- Hook
 For the Workcenter and Universalcenter 420
- Hook driver 242
- Hose holder 183, 214
 For the Toolcenter 421
- Hot glue 345
 Hot melt 345
- HS High-speed steel
 For routing tools 277
- HSS saw blade, offset (HCS)
 For oscillators 85
- HSS steel drill 240
- HW Tungsten carbide hard metal
 For routing tools 277
- I**
- IAS 3 hose 148
 IAS 3 system 120
- IAS adapter
 For compressed air eccentric sanders 146-147
- IAS double adapter
 For compressed air eccentric sanders 146-147
- IAS hose 148
- Increase
 For sliding compound mitre saws 68
- Inserts
 For SYSTAINER and SORTAINER 426-428
- Installation extractor 180, 188-189
- Installation module
 Energy box 208
 Socket 208
- Insulating material saw blade
 For pendulum jigsaws 78-79
- Interface pad
 For compressed air eccentric sanders 145
 For DUPLEX 141
 For eccentric sanders 137-138
 For PLANEX 143
 For ROTEX 134-136
- IS 330 33, 56, 73
- J**
- Jigsaw 14, 29, 38, 62-63
 Jigsaw blades 76-79
- Joining - DOMINO joining system
 Accessories and consumable materials 326
 Overview of products and applications 322
- Jointing system dowel joint unit
 For routers 272
- Jointing system VS 600 256, 272
- K**
- KA 65 336, 338, 344-345
- KAPEX
 KS 60 32, 49, 68
 KS 120 32, 51, 69
- KAPEX sliding compound mitre saw
 KS 60 32, 49, 68
 KS 88 32, 50, 69
 KS 120 32, 51, 69
- Key
 For DSC-AG 125 379, 382
 For DSC-AG 230 382
 For RG 130 378
- Keyless chuck 232-233, 235
 Key-type chuck 236
- Kickback stop
 For circular saws 64, 65
 For FS/2 418
- Knitted hat 430
- KP 65/2 339
 KS 60 32, 49, 68
 KS 88 32, 50, 69
 KS 120 32, 51, 69
- L**
- Legal information 442
- Lever clamp 275, 415, 418
- LEX 3 77 94, 121, 145-146
 LEX 3 125 94, 122, 145-146
 LEX 3 150 94-95, 123, 145-146
 LHS 225 92, 116, 143
 LHS-E 225 92, 115, 143
- Lighting
 Accessories and consumable materials 391
 Overview of products and applications 386
- Linear sander
 DUPLEX LS 130 91, 113, 141
- Lock
 For SYSTAINER pull-out drawer 424
- Long-life chip collection bag
 For cordless sanders 137, 140
- Long-life filter bag 211
- Long-life main filter 209
- Long-life spare part drill bit 242
- Long-reach sander
 PLANEX easy LHS-E 225 92, 115, 143
 PLANEX LHS 225 92, 116, 143
 LR 32 257, 273
- LR 32-SYS 427
- LRS 93 95, 124, 147
 LRS 400 95, 125, 147
 LS 130 91, 113, 141
- M**
- Machine/tool head
 For RG 80 380
 For RG 150 381
- Machining surfaces
 Accessories and consumable materials 132
 Overview of products and applications 88-96
- Magazine attachment 237
- Magazine for holding edging 344
- Magnetic spherical head
 For SYSLITE KAL II 391
- Main filter 209, 212
- Mains adapter
 For cordless sanders 137, 140
- Manual stirrer
 MX 1000 348, 351
 MX 1000/2 348, 351
 MX 1200 348, 351
 MX 1200/2 349, 352
 MX 1600/2 349, 352
 MX 1600/2 DUO 349, 353
- Masonry drills with carbide-tipped cutter 241
- Masonry renovation cleaning set 200
- MAXI-SYSTAINER 422
 SYS MAXI 422
 SYS MAXI 2 422
- Means of transport for SYSTAINER
 SYS roller 100 425
 SYS-Cart RB-SYS 425
- Metal saw blade
 For pendulum jigsaws 78-79
- MFH 1000 406, 420
 MFK 700 247, 261, 274
 MFK 700 module edge router 247, 261, 274
 MFS 254, 271
 MFT 3 398, 415
 MFT/3 CONTURO 336, 341
- Microfibre cloth 171
- MIDI-SYSTAINER T-LOC
 SYS-MIDI 3 TL 422
- Milling set
 For carpentry circular saws 67
- MINI-SYSTAINER T-LOC
 SYS-MINI 1 TL 422
 SYS-MINI 3 TL 422
- Mitre saw for boards 32, 49-51, 68-69
- Mitre tongue and groove cutter 292
- Mixing station
 For stirrers 359
- Mixing tool 350, 357-359
- Module CMS-MOD BS 120 119, 396
 Module CMS-MOD-TS 55-R 43, 396
 Module CMS-MOD-TS 75 43, 396
 Module mounting CMS-OF 252, 396
 Module mounting CMS-PS 29, 39, 396-397
 Module mounting CMS-TS 55 R 43, 396
 Module mounting CMS-TS 75 43, 396
- Modules for attachment system
 CTL/CTM/CTH 26/36/48 208
- Mortising sets
 For chain mortisers 276
- MPA 171
- Multifunction stool MFH 1000 406, 420

Multifunction table
MFT 3 398, 415
MFT KAPEX for sliding compound
mitre saws 68
MFT/3 CONTURO 336, 341
MULTI-JETSTREAM 2 150
Multi-profile cutter 295
Multi-purpose insert
For SYSTAINERS 428
Multi-routing template MFS 254, 271
Multitool 34, 57, 84
MX 1000 348, 351
MX 1000/2 348, 351
MX 1200 348, 351
MX 1200/2 349, 352
MX 1600/2 349, 352
MX 1600/2 DUO 349, 353

N

Natural oil 177
Notebook 431

O

OF 1010 246, 248, 266-267, 271, 275
OF 1400 246, 249, 268, 271
OF 2200 246, 250, 269-271
OF-FH 2200 258, 273
Office cleaning set 200
OFK 500 247, 259, 274
OFK 500 router system 302
OFK 700 247, 260, 274
Oil dispenser set 177
Oil sponge 177
Oil-absorbent nonwoven
material 151, 156, 158, 161, 167
Oils 126-127, 130, 177
One handed planer
EHL 65 EQ 310, 312, 318
Open dovetail joints
For routers 272
OS 400 34, 57, 84
Overview of product performance
features Cover
Ovolo edge cutter 285

P

Panel for bench unit 345
Panther saw blade
For circular saws 80-81
Parallel side fence
For carpentry circular saws 67
For circular saws 64-66
For DOMINO joining machines 329, 331
For FS/2 419
For modular edge router 274
For pendulum jigsaws 62
For planers 318
For routers 266, 268, 270
For row of holes system 273
For sword saws 73
PDC 18/4 21, 219, 225, 235
Pegboard hook
For the Workcenter and Universalcenter,
multifunction stool 420
Pendulum cover saw 16, 31, 44, 46, 65-66

Pendulum jigsaws
CARVEX PS 420 28, 36, 62-63
CARVEX PSB 420 28, 36, 62-63
PSB 300 28, 35, 62-63
TRION PS 300 28, 35, 62-63
Perforated top 345
Perforating roller 365, 375, 383
PF 1200 247, 262, 275
PL 205 310, 315, 319
PL 245 310, 315, 319
Plane cutter 301, 306
Planer
EHL 65 EQ 310, 312, 318
HL 850 310, 313, 318
PL 205 310, 315, 319
PL 245 310, 315, 319
Planer blades
For planers 311, 318
PLANEX easy LHS-E 225 92, 115, 143
PLANEX extractor 181, 193
PLANEX LHS 225 92, 116, 143
Planing
Accessories and consumable materials 316
Overview of products and applications 310
Planing head 314, 318
Planing set
For carpentry circular saws 67
Plasterboard V-groove cutter 293
Plastic containers
For SYSTAINER and SORTAINER 426-427
Plastic saw blade
For pendulum jigsaws 78-79
Plate 382
Platin 2 151, 153, 156, 158
plug it cable 143, 429
plug it conversion kit 429
PLUS 12
PLUS-SCA 12
Polish 344
Polish drapery 171, 177
Polish for high-gloss edging 344
Polishing 126-129, 168-176
Polishing agent 171, 344
Polishing felt 173-176, 344
Polishing fleece 177
Polishing pad
For POLLUX 170
For ROTEX 134-136
For SHINEX 170
Polishing sheepskin 173-176
PoliStick 173-176
PoliStick polishing sponge 173-176
POLLUX 180 96, 129, 170
Positioning aid set OS-AH Set
For oscillators 84
Positioning aid/depth stop set
For oscillators 84
Power box 404
PowerSelect 13
PRECISIO
CS 50 33, 53, 71
CS 70 33, 54, 72
Precision adjustable square
For compound mitre saws 70
Pre-cutter
For planer head and notch cutter 67
Preparing the substrate
Accessories and consumable
materials 376-383

Overview of products and
applications 262-265
Product identification key Cover
Professional cleaning set 200
Profile cutter 296
Profile groove cutter 297
Profile sanding pad DIY construction kit
For DUPLEX 141
Profile tongue cutter 297
Protection pad
For abrasive mesh 155, 157, 160, 162
Protector
For delta sanders 140
For eccentric sanders 137
For orbital sander RUTSCHER 140
For ROTEX 134-136
PS 300 28, 35, 62-63
PS 420 28, 36, 62-63
PSB 420 28, 36, 62-63
PSBC 420 14, 29, 38, 62-63
PSC 420 14, 29, 37, 62-63
PU adhesive 345
PU adhesive, natural 345
PU cleaner 345
PU rinsing agent 345

Q

QUADRILL
DR 20 219, 226, 236
QUADRILL drill
DR 20 219, 226, 236
QUADRIVE
DRC 18/4 20, 219, 224, 235
PDC 18/4 21, 219, 225, 235
QUADRIVE cordless drill
DRC 18/4 20, 219, 224, 235
QUADRIVE cordless percussion drill
PDC 18/4 21, 219, 225, 235
Quick-action clamp 418

R

Radius profile sanding pad
For DUPLEX 141
Radius scraper 345
RAP 150 96, 128, 170
Rapid charger
SCA 8 11, 63-65, 233, 237, 391, 421
TCL 6 11, 63-65, 233, 237, 391, 421
RAS 180 92, 114, 142
Ratchet set 239
Rear wall
For the Toolcenter 421
Rebate cutter 303
Rebate depth stop
For planers 318
Rebate profile sanding pad
For DUPLEX 141
Rebating cutter 290
Rebating head
For CMS-OF 414
For cutters 294
Reducing sleeve 205
Reducing sleeve, antistatic 204-205
Refillable cartridge for guide control black
powder
For sanders 146

Reliable grooving on the front side			
For routers	266-270, 273		
Reliable guidance			
For aluminium composite milling machines	275		
For edge routers	274		
For module edge routers	274		
For routers	266-270		
Remote control	208		
RENOFIX			
RG 80	363, 369, 380		
RG 130	362, 367, 378		
RG 150	363, 370, 381		
RENOFIX RG 130 diamond grinder	362, 367, 378		
Renovation miller			
RENOFIX RG 80	363, 369, 380		
RENOFIX RG 150	363, 370, 381		
Replacement roller	383		
Reversible blade			
For circular saws	66		
For CMS	414		
For routers	283-284, 287, 289-290, 300-301		
Reversible cutter blade			
For planer head and notch cutter	67		
For planers	318-319		
Reversible planer blade			
For planers	319		
Reversible-blade chamfer cutter	300		
Reversible-blade chamfer cutter/laminate trimmer	287		
Reversible-blade classic roundover cutter	301		
Reversible-blade edge trimming cutter	289, 300, 304		
Reversible-blade groove cutter			
For routers	271, 283-284, 304		
Reversible-blade rebating cutter	290		
RG 80	363, 369, 380		
RG 130	362, 367, 378		
RG 150	363, 370, 381		
RO 90	88, 99, 134		
RO 125	88, 98, 135		
RO 150	88, 99, 136		
Rod			
For routers	269		
Roller stand			
For semi-stationary tools	414		
For trimming saws	71-72		
Roman ogee cutter	295		
Rotary polisher			
POLLUX 180	96, 129, 170		
SHINEX RAP 150	96, 128, 170		
Rotary sanders			
RAS 180	92, 114, 142		
ROTEX			
RO 90	88, 99, 134		
RO 125	88, 98, 135		
RO 150	88, 99, 136		
ROTEX geared eccentric sander			
RO 90	88, 99, 134		
RO 125	88, 98, 135		
RO 150	88, 99, 136		
Round stirrer	357		
Roundover cutter	286, 300, 302, 306		
Roundover/chamfer cutter	286		
Router			
For DOMINO joining machines	328, 330		
Router bit box	282		
Router carriage			
For routers	271		
Router table			
For edge routers and module edge routers	274		
Routers			
OF 1010	246, 248, 266-267, 271, 275		
OF 1400	246, 249, 268, 271		
OF 2200	246, 250, 269-271		
Routing			
Accessories and consumable materials	264		
Overview of products and applications	246		
Routing aid			
For routers	268, 270, 273		
Routing circles			
For routers	266-267		
Routing edges			
With routers	273		
Routing template			
For routers	271		
RS 100	90, 106, 139		
RS 200	90, 107, 139		
RS 300	90, 108, 139		
RTS 400 R	90, 109, 140		
RTSC 400	88, 110, 140		
Rubber gasket	382		
Rubin 2	151-155, 157, 159, 161-164		
Rustic planing heads	314, 318		
Rustilon brush			
For RUSTOFIX	149		
RUSTOFIX BMS 180	93, 131, 149		
RUSTOFIX brush machine			
BMS 180	93, 131, 149		
RUTSCHER			
RS 100	90, 106, 139		
RS 200	90, 107, 139		
RS 300	90, 108, 139		
RTS 400 R	90, 109, 140		
RTSC 400	88, 110, 140		
S			
Safety cutter knife	430		
Safety filter bag	210		
Safety glasses	431		
Sanding	97-125, 134-167		
Sanding base			
For belt sanders	144		
Sanding block	149, 167, 344		
Sanding block with dust extraction	149		
Sanding disc	149		
Sanding frame			
For belt sanders	144		
Sanding head	362-363, 378-382		
Sanding pad			
For compressed air eccentric sanders	145		
For compressed air orbital sanders	147		
For DUPLEX	141		
For eccentric sanders	137-138		
For orbital sander RUTSCHER	139-140		
For PLANEX	143		
For rotary sanders	142		
For ROTEX	134-136		
Sanding vlies	151, 156, 158, 161, 167, 177, 344		
Saphir	151, 154, 156, 158-160, 165		
Saw blade for wood			
For oscillators	85		
Saw blade holder			
For CMS	414		
For trimming saws	71		
Saw blade, wood			
For oscillators	85		
Saw blades			
For circular saws	74-75		
For oscillators	85		
Sawing and oscillating			
Accessories and consumable materials	28-34		
Overview of products and applications	28-34		
SCA 8	11, 421		
Scraper	345		
For oscillators	85		
For removing coatings	141		
Scratch protector	344		
Screwdriver	239		
Script cutter	292		
Sealing slide	214		
Sealing spray	171		
Self-adhesive sanding disc	166, 172		
SELFCLEAN filter bag	210		
Semi-covered dovetail joints			
For routers	272		
Semi-stationary edge banding	341		
SERVICE all-inclusive	4-5, 9, 59, 229, 393		
Service unit			
For extractors	215		
For the Toolcenter	421		
SET	12		
Set of castors			
For the SYSTAINER port	424		
Sheepskin	173-176		
SHINEX RAP 150	96, 128, 170		
Shoulder strap			
For CT-SYS	214		
For SYSTAINERS	429		
Slat sanding pad			
For DUPLEX	141		
For orbital sander RUTSCHER	139-140		
Sleeve	204-205		
Sleeve on the container side	204		
Slideway lining			
For FS/2	418		
Sliding table			
For CMS	414		
For trimming saws	71-72		
Slot joint connection			
For routers	272		
Slot joint template			
For routers	272		
Smooth suction hose	183		
Socket spanner	235		
Softshell jacket	430		
SORTAINER			
SYS 3-SORT/4	410, 423		
SYS 3-SORT/6	410, 423		
SYS 3-SORT/9	410, 423		
SYS 3-SORT/12	410, 423		
SYS 4 TL-SORT/3	410, 423		
Spare disc for machine/tool head	380		
Spare felt			
For edge banders	344		
For pendulum jigsaws	62		
Spare part drill bit	242		
Spare part set ZOBO	242		
Special blade			
For oscillators	85		
Special cutters			
DOMINO	328, 330		
For mineral materials	304-307		

- Special saw blade
 For circular saws 82-83
 For pendulum jigsaws 78-79
- Special wood saw blade
 For pendulum jigsaws 76-77
- Spiral blade
 For planers 311, 318
- Spiral groove cutter
 For routers 272, 282-283, 304
- Spiral stirrer 357-358
- Splinter guard
 For circular saws 64
 For FS/2 418
 For pendulum jigsaws 62
 For trimming saws 71-72
- Split anchor
 For the DOMINO joining system 332-333
- Sports bag 431
- Spot lighting
 For sliding compound mitre saws 68
- Spot repair scraper 172
- Spot sander 172
- SR filter 212-213
- SSU 200 33, 55, 73
- ST DUO tripod
 For SYSLITE DUO 391
 For SYSLITE DUO 391
- Stable support
 For routers 266-270
- Staircase drilling system 243
- Standard cleaning set 200
- Standard saw blade
 For circular saws 80-81
- Stationary belt sander with BS 120 397
- Stationary bench saw with TS 75 397
- Stationary bench-mounted router
 TF 2200 Set 253, 397
- Stationary bench-mounted router with
 OF 1010 397
- Stationary jigsaw with PS 397
- Stepped cutter 285
- StickFix 150
- Stirrer 350, 357-359
 MX 1000 348, 351
 MX 1000/2 348, 351
 MX 1200 348, 351
 MX 1200/2 349, 352
 MX 1600/2 349, 352
 MX 1600/2 DUO 349, 353
- Stirrer cage 350, 357-359
- Stirrer stand
 For stirrers 359
- Stirring
 Accessories and consumable materials 354
 Overview of products and applications 348
- Stirring rod 350, 357-359
- Stirring stands
 For stirrers 359
- Stirring tool
 MX 1000 348, 351
 MX 1000/2 348, 351
 MX 1200 348, 351
 MX 1200/2 349, 352
 MX 1600/2 349, 352
 MX 1600/2 DUO 349, 353
- STL 450 386, 390-393
- STL 450 inspection light 386, 390-393
- Stop for round poles
 For DOMINO joining machines 329, 331
- Stopper
 For belt sanders 144
 For FS/2 419
 For routers 273
 For the CMS basic unit 414
 For trimming saws 71-72
- Storage surface
 For the Workcenter and Universalcenter 420
- Suction brush 207
- Suction hose
 D 21,5 203
 D 27 203
 D 27 antistatic, ordered by length 201
 D 27 smooth antistatic 201
 D 27/32 smooth antistatic 201
 D 36 203
 D 36 antistatic 201
 D 36 antistatic, ordered by length 201
 D 36 smooth antistatic 201
 D 36/32 smooth antistatic 201, 203
 D 50 203
 D 50 antistatic 202
 D 50 antistatic, ordered by length 202
 IAS 3 hoses 148
 plug it D 27/22 smooth antistatic 202
 plug it D 32/22 smooth antistatic 202
- Support
 For routers 269
 For the CMS basic unit 414
 For trimming saws 71
- Support surface extension
 For DOMINO joining machines 329
- Surface protection 344
- Surface-restoration grinder 362, 367-379
- Surface-restoration miller 363, 369-381
- SURFIX OS 130, 177
- SURFIX OS oil dispenser 130, 177
- Sword saw
 IS 330 33, 56, 73
 UNIVERS SSU 200 33, 55, 73
- SYM 70 32, 52, 70
- SYMMETRIC SYM 70 32, 52, 70
- SYS 1 BOX 426
- SYS 1 TL 422
- SYS 1 TL-DF 423
- SYS 1 UNI 426
- SYS 1 VARI 426
- SYS 2 TL 422
- SYS 2 TL-DF 423
- SYS 2 VARI 426
- SYS 3 TL 422
- SYS 3 TL-DF 423
- SYS 3-SORT/4 423
- SYS 3-SORT/6 423
- SYS 3-SORT/9 423
- SYS 3-SORT/12 423
- SYS 4 TL 422
- SYS 4 TL-SORT/3 423
- SYS 5 TL 422
- SYS adapter 214
- SYS DOCK 183
- SYS MAXI 422
- SYS MAXI 2 422
- SYS roller 100 425
- SYS tool box
 SYS-TB-1 424
 SYS-TB-2 424
- SYS-Cart RB-SYS 425
- SYS-Combi 2 423
- SYS-Combi 3 423
- SYS-HWZ 427
- SYSLITE
 DUO 386, 389, 391-393
 KAL II 24, 386, 388, 391-392
 STL 450 386, 390-393
 UNI 23, 386-387, 391-392
- SYSLITE DUO working light 386, 389, 391-393
- SYSLITE KAL II
 working light 24, 386, 388, 391-392
- SYSLITE STL 450 surface
 control light 386, 390-393
- SYSLITE UNI working light 23, 386-387, 391-392
- SYS-MFT 427
- SYS-MIDI 3 TL 422
- SYS-MINI 1 TL 422
- SYS-MINI 3 TL 422
- SYS-OF D8/D12 426
- SYS-PowerHub 409
- SYS-PowerHub power distributor 409
- SYSROCK
 BR 10 25, 408, 421
 BR 10 DAB+ 25, 408, 421
- SYSROCK site radio
 BR 10 25, 408, 421
 BR 10 DAB+ 25, 408, 421
- SYS-STF 80x133 425
- SYS-STF D125 425
- SYS-STF D150 425
- SYS-STF D225 425
- SYS-STF DELTA 100x150 425
- SYS-STF-D77/D90/93V 425
- SYS-StorageBox
 SYS-SB 424
- SYSTAINER 410, 422-423
- SYSTAINER port
 SYS-PORT 500/2 424
 SYS-PORT 1000/2 424
- SYSTAINER pull-out drawer
 SYS-AZ 424
 SYS-AZ set 424
- SYSTAINER T-LOC
 Overview 410-411
 SYS 1 TL 422
 SYS 2 TL 422
 SYS 3 TL 422
 SYS 4 TL 422
 SYS 5 TL 422
 With inlay for abrasive
 sheets 134-141, 143, 145-146, 425
- SYSTAINER T-LOC SORT-SYS 2
 For DOMINO dowels 331
- SYSTAINER T-LOC SYS-Combi
 SYS-Combi 2 423
 SYS-Combi 3 423
- SYSTAINER T-LOC SYS-MFT
 SYS-MFT 427
- SYSTAINER T-LOC with inlays for abrasives
 SYS-STF D77/D90/93V 425
 SYS-STF D125 425
 SYS-STF D150 425
 SYS-STF D225 425
 SYS-STF 80x133 425
 SYS-STF DELTA 100x150 425
- SYSTAINER T-LOC with insert for hand tools
 SYS-HWZ 427
- SYSTAINER T-LOC with lid compartment
 SYS 1 TL-DF 423
 SYS 2 TL-DF 423
 SYS 3 TL-DF 423

A - Z

Index

SYSTAINER T-LOC with multi-purpose insert	
SYS 1 BOX	426
SYS 1 UNI	426
SYS 1 VARI	426
SYS 2 VARI	426
SYS-OF D8/D12	426
SYS-TB-1	424
SYS-TB-2	424

T

T 18+3	18, 218, 222, 233
Table top insert	
For compound mitre saws	70
Tape measure	430
Taper foot roller	365, 375, 383
TC 3000/2	407, 421
TCL 6	11, 421
Telescopic drawer	
For the SYSTAINER port	424
Template-kit	
For routers	272
Terminal	
For sliding compound mitre saws	69
TF 1400	246, 253
TF 1400 Set	253, 397
TF 2200	246, 253
The perfect edge	337
Through-hole drill	
For routing	295
Timber framing saw	31, 48, 67
Tongue and groove cutter	292
Tool holder	
For extractors	208, 214
For PLANEX	143
For the Toolcenter	421
Tool hook	
For the Workcenter and Universalcenter	420
Toolcenter TC 3000/2	407, 421
Toolie multifunction tool	430
Tooth shapes	75
TP 220	365, 375, 383
TP 220 wallpaper perforator	365, 375, 383
TPE-RS 100	365, 374, 383
Trammel unit	
For routers	267
Trim stop	
For DOMINO joining machines	329, 331
Trimming attachment	
For sliding compound mitre saws	68-69
For trimming saws	71-72
Trimming edging	339
Trimming machine KP 65/2	339
Trimming saw	33, 53-54, 71-72
PRECISIO CS 50	33, 53, 71
PRECISIO CS 70	33, 54, 72
TRION PS 300	28, 35, 62-63
Triple flat tooth saw blade	75
TS 55 R	30, 40, 64
TS 75	30, 42, 64
TSC 55	15, 30, 41, 64
TSC 55 cordless plunge-cut saw	15, 30, 41, 64
T-slot cutter	295
Tubes	206
Turbo combination suction brush	207
Turbo filter bag	
For eccentric sanders	138
For orbital sander RUTSCHER	139

Twin box	239
Twist drill bits	240
Two-ply filter bag	213
TXS	218, 220, 232

U

UCR 1000	406, 420
UCR 1000 Universalcenter	406, 420
Underframe	
For sliding compound mitre saws	68-69
UNIVERS SSU 200	33, 55, 73
Universal brush nozzle	207
Universal cleaning set	200
Universal extractor	180, 186
Universal saw blade	
For circular saws	80-81
For pendulum jigsaws	76-77
Upholstery nozzle	207

V

VAC SYS	399, 416
VAC SYS vacuum clamping system	399, 416
Vacuum clamping nozzle CT WINGS	214, 402
Vacuum hose	
For VAC SYS	416
Vacuum pad	
For VAC SYS	416
Vacuum pump	
For VAC SYS	416
Vacuum unit	
For VAC SYS	416
VECTURO OS 400	34, 57, 84
VECTURO OS 400 oscillator	34, 57, 84
V-groove cutter	
For routers and aluminium composite milling machines	275, 293
V-groove profile sanding pad	
For DUPLEX	141
VS 600 GE	256, 272

W

Wall mounting	
For EAA	417
Water gutter cutter	288
WCR 1000	405, 420
Weather-proof dowels	329, 331
Wet filter	209
Wet/dry dust extractor	180-181, 186, 188-197
Wooden dowels	328-332
Workcenter WCR 1000	405, 420
Workplace organisation	
Accessories and consumable materials	412

Y

Y-piece, antistatic	205
---------------------	-----

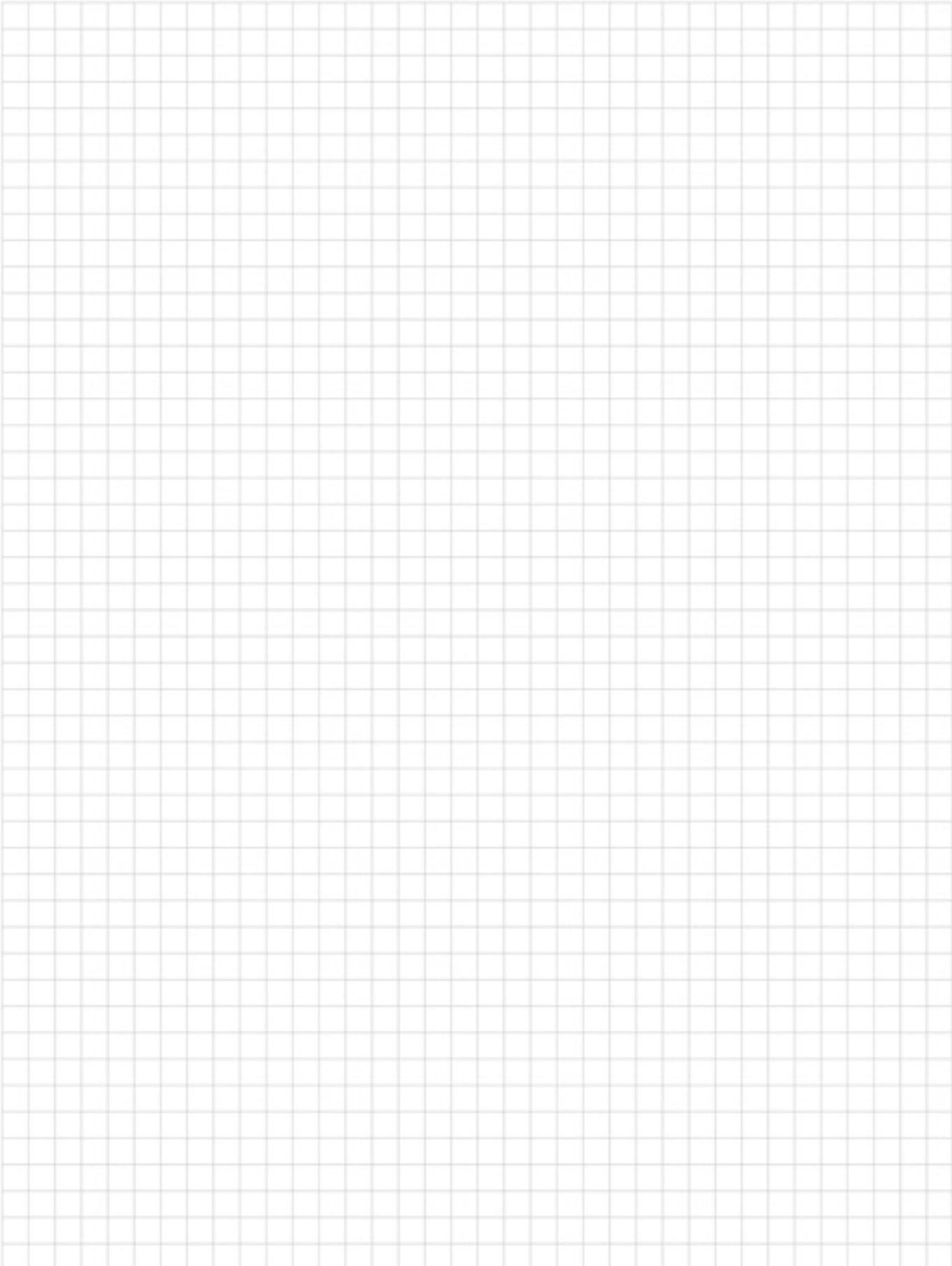

General notes on the catalogue:

1. Please remember to fit appropriate protective devices or wear personal protective equipment when using Festool products such as compressed air and electric power tools with accessories and consumable materials or when machining hazardous materials. For further information, please refer to the relevant safety documentation or consult the relevant regulating authority if you have questions.
2. Machine specifications included in the catalogue, such as quantity specifications, time savings, coverage capacities, etc., are average values and may deviate significantly, depending on the material being processed. The manufacturer does not guarantee that the values will be achieved in each individual case. Your Festool specialist dealer will be glad to answer any queries you may have concerning this matter.
3. The machine weights specified in the catalogue usually refer to the weight of a machine ready for use and with a standard tool, but without a cable, accessories or consumables. Please note that the weights stated may deviate from the specifications in the catalogue, depending on the tool, battery pack, accessories or other additional parts used.
4. All trademark rights, patent rights and other commercial property rights mentioned in this catalogue remain the property of the relevant beneficiary, even in cases where this is not explicitly stated. The reproduction in particular of common names, trade names, goods designations, etc. in this catalogue (even if not identified as such) does not render these names exempt from trademark or brand protection legislation and does not therefore authorise anyone to use them.
5. We reserve the right to make modifications, especially to technical data or specifications, without prior notification. Individual features may vary depending on country-specific conditions.
6. Products may differ from those shown and the images may at times present components or parts that are not included as standard with the tools. If you have any questions, please contact your Festool specialist retailer.
7. Safety: All power tools and compressed air tools listed in this catalogue conform to the valid and applicable IEC or EN safety standards, depending on the type of tool (e.g. IEC/EN 61 029, IEC/EN 60 745, IEC/EN 62 841, IEC/EN 60 335, EN ISO 11 148, IEC/CISPR/EN 55 014, IEC/EN 61 000).
8. Insulation: The power tools listed in this catalogue are insulated in accordance with regulations.
9. CE conformity: All power tools and compressed air tools listed in this catalogue comply with the provisions of the relevant applicable EU directives (e.g. Machinery Directive 2006/42/EC, Low Voltage Directive 2014/35/EU, EMC Directive 2014/30/EU, RoHS Directive 2011/65/EU).
10. ISO certification: All the power tools and compressed air tools listed in this catalogue are manufactured in our production plants which are DIN EN ISO 9001 certified.



Egypt

Equipment plus sarl
Mkales street 41
Beirut
Tel. 00961 16 92 136
Fax 00961 99 25 993
info@equipment-plus.com
www.equipment-plus.com



Algeria

PRO' DISTRIBUTEUR sarl
NIF 099909080287849
LOTISSEMENT AIDJA BOUFARIK ALGERIE
Tel. 00213 25 28 39 12/13
Fax 00213 25 28 39 14
info@pro-dist.com
www.pro-dist.com



Azerbaijan

Alman Texnikalari Evi MMC
A. Molla Cuma kuc. 32
1072 Baku, Azerbaijan
Tel. 0099 4 12 565 23 23
Fax 0099 4 12 565 23 30
ate_mmc@yahoo.com
www.atemmc.com



Australia

Tooltechnic Systems Australia
21-27 Evolution Drive
Dandenong South VIC 3175
Tel: 1300 063 900
Fax: (03) 8845 7079
Email: customercare@tooltechnic.com.au
www.festool.com.au



Belgium

Festool Belgium NV/SA
Rue Colonel Bourgstraat 101
1030 Brussel
Tel. 0032 2 893 36 36
Fax 0032 2 726 98 81
info-be@festool.com
www.festool.be



Bosnia-Herzegovina

MAJO D.O.O.
Goričica pri Ihanu 2
1230 Domžale (Slovenija)
Tel. 00386 17 24 82 16
Fax 00386 17 24 11 07
majo.doo@siol.net
www.majo.si



Brazil

W&S Saura Ltda.
Av. José Fortunato Santon 580
Distrito Industrial Abdo Najar
13474-750 Americana/ São Paulo
Tel. 0055 19 3469-9889
Fax 0055 19 3469-9888
ws@wsequipamentos.com.br
www.wsequipamentos.com.br



Bulgaria

Tooltechnic Systems EOOD
9, Christopher Columbus Blvd.
1592 Sofia
Bulgaria
Tel. 00359 888574208, 00359 888989917
office@festool.bg
www.festool.bg



Chile

SOCIEDAD RHEKO LTDA.
Victoria 984, Villa Llacolen
San Pedro de la Paz
4130000 Concepcion
Tel.: 0056 41 2372 060
Info@reko.cl
www.reko.cl



China

Festool China
1159 Kangqiao East Rd, No.91-Buildg 1
Kangqiao Industrial Zone
201315 Shanghai (Pudong)
Tel. 0086 21 68 18 28 00
Fax 0086 21 68 18 26 90
info@festool.cn
www.festool.cn



Denmark

Festool Danmark ApS
Postboks 1242
2300 København S
Tel. 0045 44 84 20 24
info-dk@festool.com
www.festool.dk



Germany

Festool Deutschland GmbH
Wertstrasse 20
73240 Wendlingen a.N.
Tel. 0049 (0)7024/ 804-24010
Fax 0049 (0)7024/ 804-29699
vertrieb@festool.com
www.festool.de



Estonia

UAB „TTS Tooltechnic Systems“
Ašigalio g. 6
LT-49142, Kaunas, Lietuva
Tel. 00370 37 308 414
Fax 00370 37 323 848
info@tts-company.lt
www.festool.ee



Finland

Tooltechnic OY
Mäkituvantie 7
01510 Vantaa
Tel. 00358 10 22 95 111
info@festool.fi
www.festool.fi



France

Festool France
33 rue Gabriel
77185 LOGNES
Tel. 00 33 (1) 60 06 64 30
Fax 00 33 (1) 60 06 62 26
info-fr@festool.com
www.festool.fr



Georgia

LTD Electron
Agladze str. 7/a
0154 Tbilisi
Tel. 00995 32 2911121
Mobil: 00995 599 291122
contact@rcheuli.com
khaduri@gmail.com
www.rcheuli.com



Greece

Hellenic Tool Center
Driadon 4
141 22 Neo Heraklio (Attica)
Tel. 0030 21 02 81 10 72
Fax 0030 21 02 81 17 64
festool@otenet.gr
www.hellenictoolcenter.gr



Great Britain

Festool UK Ltd
Saxham Business Park, Saxham
Bury St. Edmunds, Suffolk
IP28 6RX
Tel. 0044 1284 760 791
Fax 0044 1284 702 156
info@festool.co.uk
www.festool.co.uk



India

Caple Industrial Solutions,
WEH, Malad E, Mumbai 97.
Delhi +91 9999394047
Mumbai +91 9930069906
Bengaluru +91 9148788500
Kolkata +91 9599487490
festool.cat@caple.in
www.caple.in



Ireland

TTS Tooltechnic Systems Ireland Ltd
C/O McCann Duffy Cleary, E12 Calmount Park
Ballymount
Dublin 12
Tel. 00353 18 64 22 40
Fax 00353 18 64 22 47
sales@festool.ie
www.festool.ie



Iceland

ISOL Ltd.
P.O. Box 8436
Armuli 17
128 Reykjavik
Tel. 00354 53 31 234
Fax 00354 56 80 499
isol@isol.is
www.isol.is



Iceland

Husasmidjan Ehf
Holtvegur 10
104 Reykjavik
Tel. 00354 525 3000
jono@husa.is
www.husa.is



Israel

A. Sherizly & Son Ltd.
Shderot Hamiktsot, 15
Einav Center
Modiin - 7177849
Tel. 00972 89 23 37 77
Fax 00972 89 23 44 77
sherizly@sherizly.com
www.festool.com



Italy

Festool Italia S.r.l.
Agente per l'Italia del marchio Festool
Via Galileo Galilei 16
20090 Assago MI
Tel. 0039 02 457851
Fax 0039 02 45785320
marketingit@festool.com
www.festool.it



Japan

Häfele Japan K.K.
14-17, Kami-Shinano, Totsuka-ku
244-0806 Yokohama
Tel. 0081 45 82 83 111
Fax 0081 45 82 83 110
festool@hafele.co.jp
www.festool.jp



Jordan

Equipment plus sarl
Mkales street 41
Beirut
Tel. 00961 16 92 136
Fax 00961 99 25 993
info@equipment-plus.com
www.equipment-plus.com



Canada

Tooltechnic Systems, LLC
400 N. Enterprise Blvd
Lebanon, IN 46052
Tel. 001 88 83 37 86 00
Fax 001 76 54 83 09 03
sales@festoolcanada.com
www.festoolcanada.com



Kazakhstan

Voronin I.V.
Mikrorayon Aksay 3 a, dom 80
050031 Almaty
Tel. 007 727 242 94 55
ritm@ritm.asia
www.ritm.ttd.kz



Qatar

Equipment plus sarl
Mkales street 41
Beirut
Tel. 00961 16 92 136
Fax 00961 99 25 993
info@equipment-plus.com
www.equipment-plus.com



Columbia

Ferreteria Al-Diaz
Cra. 50 No. 71C-31
Bogotá, D.C.
Tel. 0057 1 660 0083
Fax 0057 231 4350
gerencia@ferreteriadiaz.com
www.ferreteriadiaz.com



Croatia

ALAGO d.o.o.
Horvati 112
10436 Rakov Potok
Tel. 00385 1 653 93 92
Fax 00385 1 653 93 93
info@alago.hr
www.alago.hr



Latvia

UAB „TTS Tooltechnic Systems“
Ašigalio g. 6
LT-49142, Kaunas, Lietuva
Tel. 00370 37 308 414
Fax 00370 37 323 848
info@tts-company.lt
www.festool.lv



Lebanon

Equipment plus sarl
Mkales Street 41
Beirut, Lebanon
Tel. 00961 1 692136
Mobile 00961 71 861234
info@equipment-plus.com
www.equipment-plus.com



Lithuania

UAB „Festool LT“
Ašigalio g. 6
LT-49142, Kaunas, Lietuva
Tel. 00370 37 308 414
Fax 00370 37 323 848
info@festool.lt
www.festool.lt



Luxembourg

Festool Belgium SA/NV
Agent Festool
Rue Colonel Bourgstraat 101
B - 1030 Bruxelles/Brussel
Tel. 0032 2 893 36 36
Fax 0032 2 726 98 81
info-be@festool.com
www.festool.be



Malta

PIOVE HOLDINGS Ltd.
C&C Technik
Profs Carmelo Coliero Street
Handaq Industrial Estate
Handaq
QRM4005 Qormi
Tel. 00356 21 44 67 98
Info@cctechnikmalta.com
www.cctechinikmalta.com



Macedonia

Rosa Doool
st. Jadranska Magistrala 90
1000 Skopje
Tel. 00389 022 602 092
Fax 00389 022 602 093
info@rosa.com.mk
contact@rosa.com.mk
www.rosa.com.mk



Moldova

UAB „TTS Tooltechnic Systems“
Ašigalio g. 6
LT-49142, Kaunas, Lietuva
Tel. 00370 37 308 414
Fax 00370 37 323 848
info@tts-company.lt
www.tts-company.lt



New Zealand

Hindin Marquip Ltd.
1012 Great South Road
1061 Penrose - Auckland
Tel. 0064 9 9131661
hamish@hml.co.nz
www.hml.co.nz



The Netherlands

Festool Nederland B.V.
Coenecoop 2 G
2741 PG Waddinxveen
Tel. 0031 18 26 21 940
Fax 0031 18 26 21 949
info-nl@festool.com
www.festool.nl



Norway

MOTEK AS
Alf Bjerkesvei 22 B
BOX 81 Oekern
0508 Oslo
Tel. 0047 23 05 25 00
Fax 0047 22 64 00 63
odd-arve.rygh@motek.no
www.motek.no



Austria

Festool Österreich GmbH
Schloss Glanegg 2
5082 Grödig
Tel. 0043 (0)810/95 53 14
Fax 0043 (0)810/95 53 12
vertrieb-at@festool.com
www.festool.at



Panama

Formica Distribution Center, S.A.
City of Panama, Panama, street
85, Urb. Ind. Los Angeles
0832-2532 WTC PANAMA
Tel. 00507 260 5503
Fax 00507 260 1440
grettel.amores@bacosa.com
www.renpar.com.py



Paraguay

Renpar S.A.
Juan Leopardi N° 1879 c/ Pedro Peña
2160 San Lorenzo
Tel. 00595 21 51 13 29
Fax 00595 21 51 13 29
nlopes@renpar.com.py
www.formicadistributioncenter.com



Peru

EURO TOOLS MASCHINEN E.I.R.L.
Costa Rica N° 513
J. Hunter, Arequipa
Tel. 0051 54 65 7454 / 0051 54 65 7455
Mob. 958370884 / 997375706
euroimportacion@hotmail.com
eurotoolsmaschinen@hotmail.com
www.euro-importacion.com



Poland

Festool Polska Sp. z o.o.
Sokotów, ul. Sokotowska 47a
05-806 Komorów
Tel. 0048 22 122 74 00
Fax 0048 22 122 74 01
info-pl@festool.com
www.festool.pl



Portugal

Tooltechnic Systems Unipessoal, Lda
Zona Industrial Pau Queimado
E.N. 5, Armazém 25
2870-500 Montijo
Tel. 0034 93 264 30 30
Fax 0034 93 264 30 31
info-pt@festool.com
www.festool.pt



Romania

Tooltechnic System Kft.
Lakatos út 40.
1184 Budapest
Tel. 0036 12 97 13 50
Fax 0036 12 97 13 59
info@festool.hu
www.festool.ro



Russia

TTS Tooltechnic Systems 000
Russia, Moscow region
Noginsk district, 142400 Noginsk,
Noginsk-Technopark area, 13
Tel. 007 49 57 75 83 54
Fax 007 49 56 41 23 72
info@festool.ru
www.festool.ru



Saudi Arabia

Equipment plus sarl
Mkales street 41
Beirut
Libanon
Tel. 00961 1 692136
bejjanizad@equipment-plus.com
www.equipment-plus.com



Sweden

Festool Sverige AB
Stenåldersgatan 3
213 76 Malmö
Tel. 0046 40 670 10 00
info-se@festool.com
www.festool.se



Switzerland

Festool Schweiz AG
Moosmattstr. 24
8953 Dietikon
Tel. 0041 44 744 27 27
Fax 0041 44 744 27 28
info-ch@festool.com
www.festool.ch



Serbia

MAKSAL LINE D.O.O.
Pavla Pavlovića 11
office: Radojke Lakić 6
11000 BEOGRAD
Mob. 00381 64 127 7581
Tel. 00381 11 407 8421
Fax 00381 11 2412 266
maksal.bg@gmail.com
www.maksal-line.rs



Singapore

Hiap Huat Chemicals & Industrials Co.
19 Tanjong Penjuru
609021 Singapore
Tel.: 0065 67 45 4111
Fax: 0065 67 46 29 77
chem@hiaphuat.com.sg
www.hiaphuat.com.sg



Slovakia

Festool CZ s.r.o.
Chelčického 1932
CZ - 470 37 Česká Lípa
Tel. 00420 48 16 45 162
festool.info@festool.com
www.festool.cz



Slovenia

MAJO D.O.O.
Goričica pri Ihanu 2
1230 Domžale
Tel. 00386-17 248 216
Fax 00386-17 241 107
majo.doo@siol.net
www.majo.si



Spain

Festool Spain, S.L.U.
Parque Empresarial Cityparc - Edificio Lisboa.
Carretera de L'Hospitalet 147-149
CP 08940 Cornellà de Llobregat
Tel. 0034 93 264 30 30
Fax 0034 93 396 95 27
info-es@festool.com
www.festool.es



South Africa

Vermont Sales (Pty) Ltd
192 Tsessebe Crescent,
Corporate Park South, Old Pretoria Road,
Randjespark, Midrand, South Africa
PO Box 264, Halfway House, 1685
Tel. 0027 (0)11 314 7711
Fax 0027 (0) 866 88 66 33
orders@vermontsales.co.za
www.festool-powertools.co.za



South Korea

Festool Korea Ltd.
501-2ho, 67, Malgeunnae-gil, Uiwang-si,
Gyeonggi-do, 16071,
Republic of Korea
Tel. 0082 02 6002 6740
Fax 0082 02 6022 6799
info-kr@festool.com



Taiwan

Bestor Trading Corp.
No.12, Chung-Yang Lane
Kuang-Fu Village Shetou
Hsiang Chang-Hua Hsien
Tel. 00886 48 72 66 97
Fax 00886 48 72 52 09
bestor.steven@msa.hinet.net
www.bestor.com.tw



Thailand

Häfele (Thailand) Ltd.
57 Soi Sukhumvit 64
Bangjak Prakhonong
10260 Bangkok
Tel. 0066 27 41 71 71
Fax 0066 27 41 72 72
festool@hafele.co.th
www.hafele.com/th/en



Czech Republic

Festool CZ s.r.o.
Chelčického 1932
CZ - 470 37 Česká Lípa
Tel. 00420 48 16 45 162
festool.info@festool.com
www.festool.cz



Turkey

www.festool.com.tr



Ukraine

UAB „TTS Tooltechnic Systems“
Ašigalio g. 6
LT-49142, Kaunas, Lietuva
Tel. 00370 37 308 414
Fax 00370 37 323 848
info@tts-company.lt
www.festool.ua



Hungary

Tooltechnic System Kft.
Lakatos út 40.
1184 Budapest
Tel. 0036 12 97 13 50
Fax 0036 12 97 13 59
info@festool.hu
www.festool.hu



Uruguay

Luganer S.A.
Martín C. Martínez 2126
Montevideo 11800
Tel. 00598 24 090 100
centroventas@luganer.com.uy
www.luganer.com.uy



USA

Tooltechnic Systems, LLC
400 N. Enterprise Blvd
Lebanon, IN 46052
Tel. 001 88 83 37 86 00
Fax 001 76 54 83 09 03
sales@festoolusa.com
www.festoolusa.com



Venezuela

Materiales Manzanillo c. a
Juan Baustista arismendi
001 Porlamar. Isla de Margarita
Tel. 0058 295 2744 601
Fax 0058 295 2744 783
Jou37@hotmail.com



United Arab Emirates

POLIMAR
Unit D-8 Sharjah Furniture Complex
Al Wahda Street
P.O. Box 433 Sharjah
Tel. 00971 65 33 41 47
Fax 00971 65 33 00 09
polimar@emirates.net.ae
www.polimar.com



Belarus

UAB „TTS Tooltechnic Systems“
Ašigalio g. 6
LT-49142, Kaunas, Lietuva
Tel. 00370 37 308 414
Fax 00370 37 323 848
info@tts-company.lt
www.festool.by



Cyprus

K and S Industrial Supplies Ltd.
31, Vasilissis Frederikis street
P.O. Box 27147
1642 - Nicosia
Tel. 00357 22 67 46 64
Fax 00357 22 67 22 40
seraphim@cytanet.com.cy
www.festool.com

FESTOOL

Festool UK Ltd

Saxham Business Park
Saxham
Bury St Edmunds
Suffolk
IP28 6RX
Great Britain
Phone: +44 (0) 1284 760 791
Fax: +44 (0) 1284 702 156
E-mail: info@festool.co.uk

Registered office address:

TTS Tooltechnic Systems Ltd

c/o Duffy Cleary
E12 Calmount Park
Ballymount
Dublin 12
Place of registration: Ireland
Company No.: 133724

Phone: +353 1 8642240
Fax: +353 1 8642247
E-Mail: sales@festool.ie
Web www.festool.ie

www.festool.co.uk

Art. no. 067 253 GB/en



Festool catalogue 2018

As at: 01/2018, replaces all previous catalogues.

Subject to alterations and errors.
Products may differ from those pictured.

Product performance features



Antistatic function

Mobile dust extractors and tools with the antistatic function to prevent static charge from accumulating when working.



LED spotlight

LED light for simple and precise placement against the scribe mark.



Dual-line laser

Two laser lines for simple, precision positioning along the scribe mark from the left or right.



Torque shut-off

Intelligent technology ensures the optimum screwdriving force for every material.



Jigsaw with precision guidance

Long-wearing carbide jaws guide the saw blade directly over the cutting location. For precise work results.



AUTOCLEAN

AUTOCLEAN automatic main filter cleaning system with infinitely adjustable cleaning intervals.



FlowDetect

Health protection: The flow sensor checks for a minimum air speed of 20 m/sec and issues a warning if the air speed falls below this value.



Spir-O-Cut

single-edged planer head offers crucial advantages: No need to adjust cutting circle diameter after blade replacement, and oblique shearing for high surface quality



Electronic

Speed control for adjusting to all types of materials.



MMC electronics

"Multi Material Control" power electronics with constant adjustable speed and temperature monitor for work on all types of material.



MMC digital electronics

Processor controlled "Multi Material Control" power electronics provide adjustable and constant speeds as well as temperature monitoring for work on all types of material.



PoliStick

Fast fixing concept for attaching polishing felt, polishing sponges or sheepskins – for greater efficiency.



IAS 3 system

Hose system incorporates compressed air, dust extraction and exhaust air.



IAS 3 light

Dust extraction, compressed air with external exhaust air dissipation.



IAS 3-SD

For connecting a Festool compressed air sander directly to a compressed air line (without dust extraction).



IAS 2 system

Combines three functions in one hose: compressed air supply, exhaust air extraction and dust extraction.



Smooth suction hose

With a smooth exterior which allows it to slide over surfaces perfectly.



Standard connection

Standard connection for dust extractors.



EC-TEC

The EC-TEC drive concept generates an extraordinary amount of power while consuming extremely low amounts of energy.



StickFix

Quick, economical fastening system for abrasives – no adhesives, no clamping.



MPE sanding pad

Sanding pads and sanding discs made from extremely durable materials for long service life.



Lithium-ion (Li)

Fitted with high-performance lithium ion battery pack.



Jetstream principle

The 9-hole principle for reduced dust accumulation, less heat and less clogging. Up to a 30% longer service life.



MULTI-JETSTREAM 2 principle

Sanding system with integral dust conveying concept. With the patented MULTI-JETSTREAM 2 principle.



SDS-plus

Tool holder for quick tool changes.



AIRSTREAM battery

Faster charging of battery packs thanks to AIRSTREAM technology (cooling function for faster charging) and significantly increased charging capacity.



High torque

Tool with high torque.



Protector

Protects the sanding pad and material when working close to edges.



Impact stop

Allows manual deactivation of the impact function when drilling into wood or brittle materials.



Electronic monitoring

Electronic monitoring of the coil temperature protects against damage to the motor.



Splinter guard

Patented splinterguard for splinter-free cuts on both sides when sawing.



Safety sliding clutch

Mechanical sliding clutch provides protection if the tool suddenly seizes or tilts.



Start/stop function

AUTO mode, also without having to press the main switch.



Guide system

Patented guide system for safe guidance of saws and router bits.



Trimming rails

Compound mitre saw system which securely joins machine and cross cutting guide rails together for precisely accurate repeat cuts.



ErgoFix adapter

For holding a M14 stirring rod.



Quick-acting brake

For safe work when planing, sawing and routing.



FastFix

Makes changing routing, sawing, planing, sanding, drilling and screwdriving tools easier.



Starting current limiter

Simple start for household fuses.



plug it

Removable, replaceable mains cable with safety lock for quick conversion.



CLEANTEC dust extraction

Standard connector (27/36/50 mm) for dust extraction to safeguard the operator and the environment.



CLEANTEC connecting system

Integrated bayonet fitting as the connecting element between the extractor and the tool.



Electronic overload protection

Protects the motor with blocking tool.



Vibration stop

Patented VS balancing so that tools run smoothly during sanding, which makes working less hazardous.



Groove in saw table

lever clamps on the saw table fix the workpiece securely and prevent it from shifting accidentally



Electro-dynamic run-down brake

The chainsaw will stop immediately once the speed controller is released.



Turbo dust extraction

Turbo dust extraction ensures clean, dust-free air and a clear view of the workpiece.



Bluetooth interface

Use of mobile devices via the Bluetooth standard.



Hands-free function

Telephone conversations (in full duplex) via feedback.



USB port

For charging external devices.



DAB+

Playback with the DAB+ standard.



Forward/Reverse rotation

For screwing and unscrewing screws.



Tip:

Are you already familiar with myFestool?
You can find all the important information
about your Festool products and the entire
range of Festool services in your personal
online area.

www.festool.co.uk/myfestool

Product identification key

Product type	Performance class	Equipment variants	Packed in a SYSTAINER	Also included in delivery
RO	150	FEQ	Plus	Set
	Pad Ø, container volume, etc.	F Tool change system E Electronic B Quick-acting brake CE CENTROTEC Q plug it SG Hose holder EW Electric tool DW Compressed air tool LE Compressed air variant	with a SYSTAINER	Extensive range of accessories included with the product

In self-service display pack Accessory is positioned in the retailer for self-operation