

POWERMATIC®

Operating Instructions and Parts Manual 25-inch Planer Model WP2510



WMH TOOL GROUP, Inc.

2420 Vantage Drive
Elgin, Illinois 60124
Ph.: 800-274-6848
www.wmhtoolgroup.com

Part No. M-1791303

Revision C 6/07

Copyright © 2007 WMH Tool Group, Inc.

Warranty and Service



WMH Tool Group, Inc., warrants every product it sells. If one of our tools needs service or repair, one of our Authorized Service Centers located throughout the United States can give you quick service. In most cases, any of these WMH Tool Group Authorized Service Centers can authorize warranty repair, assist you in obtaining parts, or perform routine maintenance and major repair on your POWERMATIC® tools. For the name of an Authorized Service Center in your area call 1-800-274-6848.

MORE INFORMATION

WMH Tool Group is consistently adding new products to the line. For complete, up-to-date product information, check with your local WMH Tool Group distributor, or visit powermatic.com.

WARRANTY

POWERMATIC products carry a limited warranty which varies in duration based upon the product.

	Industrial Products Horizontal Panel Saws Cut Off Saws Rip Saws Bandsaws Jointers Planers Oscillating Edge Sanders	Belt Sanders Shapers Power Feeders Mortisers Dovetailers		Non-Industrial Products Tablesaws Vertical Panel Saws Bandsaws Jointers Planers Planer/Molder Dust Collection	Disc Sanders Edge Sanders Drum Sanders Shapers Drill Press's Mortisers Dovetailers
---	--	--	--	---	--

Warranty reverts to 1 Year if above products are used for commercial, industrial or educational purposes

WHAT IS COVERED?

This warranty covers any defects in workmanship or materials subject to the exceptions stated below. Cutting tools, abrasives and other consumables are excluded from warranty coverage.

WHO IS COVERED?

This warranty covers only the initial purchaser of the product.

WHAT IS THE PERIOD OF COVERAGE?

The general POWERMATIC warranty lasts for the time period specified in the product literature of each product.

WHAT IS NOT COVERED?

The Five Year Warranty does not cover products used for commercial, industrial or educational purposes. Products with a Five Year Warranty that are used for commercial, industrial or education purposes revert to a One Year Warranty. This warranty does not cover defects due directly or indirectly to misuse, abuse, negligence or accidents, normal wear-and-tear, improper repair or alterations, or lack of maintenance.

HOW TO GET SERVICE

The product or part must be returned for examination, postage prepaid, to a location designated by us. For the name of the location nearest you, please call 1-800-274-6848.

You must provide proof of initial purchase date and an explanation of the complaint must accompany the merchandise. If our inspection discloses a defect, we will repair or replace the product, or refund the purchase price, at our option.

We will return the repaired product or replacement at our expense unless it is determined by us that there is no defect, or that the defect resulted from causes not within the scope of our warranty in which case we will, at your direction, dispose of or return the product. In the event you choose to have the product returned, you will be responsible for the handling and shipping costs of the return.

HOW STATE LAW APPLIES

This warranty gives you specific legal rights; you may also have other rights which vary from state to state.

LIMITATIONS ON THIS WARRANTY

WMH TOOL GROUP LIMITS ALL IMPLIED WARRANTIES TO THE PERIOD OF THE LIMITED WARRANTY FOR EACH PRODUCT. EXCEPT AS STATED HEREIN, ANY IMPLIED WARRANTIES OR MERCHANTABILITY AND FITNESS ARE EXCLUDED. SOME STATES DO NOT ALLOW LIMITATIONS ON HOW LONG THE IMPLIED WARRANTY LASTS, SO THE ABOVE LIMITATION MAY NOT APPLY TO YOU.

WMH TOOL GROUP SHALL IN NO EVENT BE LIABLE FOR DEATH, INJURIES TO PERSONS OR PROPERTY, OR FOR INCIDENTAL, CONTINGENT, SPECIAL, OR CONSEQUENTIAL DAMAGES ARISING FROM THE USE OF OUR PRODUCTS. SOME STATES DO NOT ALLOW THE EXCLUSION OR LIMITATION OF INCIDENTAL OR CONSEQUENTIAL DAMAGES, SO THE ABOVE LIMITATION OR EXCLUSION MAY NOT APPLY TO YOU.

WMH Tool Group sells through distributors only. The specifications in WMH catalogs are given as general information and are not binding. Members of WMH Tool Group reserve the right to effect at any time, without prior notice, those alterations to parts, fittings, and accessory equipment which they may deem necessary for any reason whatsoever.

Table of Contents

Warranty and Service	2
Table of Contents	3
Warning.....	5
Introduction	7
Specifications	7
Unpacking	8
Contents of the Shipping Container	8
Installation and Assembly	9
Dust Hood.....	9
Grounding Instructions.....	10
230 Volt Operation	10
Converting from 230 Volt to 460 Volt	11
Test Run	11
Controller Set-Up	11
Adjustments	11
Depth of Cut.....	11
Feed Rate.....	12
Belt Tension.....	12
Opening Hood.....	12
Replacing or Rotating Knife Inserts	12
The Planer's Feed System.....	13
Table Adjustments	16
Test Cutting and Troubleshooting	17
Operation	19
Maintenance.....	19
Lubrication	19
Controller (M15S) Operating Instructions	20
1. Front Panel Overview.....	20
2. Operation Modes.....	21
3. Fast Program (10 sets).....	24
4. Select Counting direction.....	26
5. Select Positioning Mode.....	26
6. Set Software Limit (Hi/Lo End)	27
7. Set Tolerances	27
8. Set Low Speed Limit	28
9. Set Linear Correction	29
10. Enter Parameter Settings Mode.....	29
11. Check Software Version	30
12. Load Datum Values.....	30
13. IN/MM Conversion.....	32
14. Set Device Resolution	32
15. Calibration.....	33
16. M15S Troubleshooting	33
17. M15S Specifications.....	35
Troubleshooting: Planer Operating Problems.....	36
Troubleshooting: Mechanical and Electrical Problems.....	37
Replacement Parts	38
Column Assembly	39
Parts List: Column Assembly.....	40
Gearbox Assembly.....	42
Parts List: Gearbox Assembly	43
Parts List: Cutterhead Assembly	44
Table Assembly	46
Parts List: Table Assembly	47
Base Assembly	48
Parts List: Base Assembly.....	49
Parts List: Top Cover Assembly	52

Parts List: Top Cover Assembly	52
Parts List: Electrical Box Assembly.....	53
Electrical Connections – 230Volt.....	54
Electrical Connections – 460Volt.....	55



Warnings

1. Read and understand the entire owners manual before attempting assembly or operation.
2. Read and understand the warnings posted on the machine and in this manual. Failure to comply with all of these warnings may cause serious injury.
3. Replace the warning labels if they become obscured or removed.
4. This planer is designed and intended for use by properly trained and experienced personnel only. If you are not familiar with the proper and safe operation of a planer, do not use until proper training and knowledge have been obtained.
5. Do not use this planer for other than its intended use. If used for other purposes, WMH Tool Group disclaims any real or implied warranty and holds itself harmless from any injury that may result from that use.
6. Always wear approved safety glasses/face shields while using this planer. Everyday eyeglasses only have impact resistant lenses; they are not safety glasses.
7. Before operating this planer, remove tie, rings, watches and other jewelry, and roll sleeves up past the elbows. Remove all loose clothing and confine long hair. Non-slip footwear or anti-skid floor strips are recommended. Do **not** wear gloves.
8. Wear ear protectors (plugs or muffs) during extended periods of operation.
9. Some dust created by power sanding, sawing, grinding, drilling and other construction activities contain chemicals known to cause cancer, birth defects or other reproductive harm. Some examples of these chemicals are:
 - Lead from lead based paint.
 - Crystalline silica from bricks, cement and other masonry products.
 - Arsenic and chromium from chemically treated lumber.Your risk of exposure varies, depending on how often you do this type of work. To reduce your exposure to these chemicals, work in a well-ventilated area and work with approved safety equipment, such as face or dust masks that are specifically designed to filter out microscopic particles.
10. Do not operate this machine while tired or under the influence of drugs, alcohol or any medication.
11. Make certain the machine is properly grounded.
12. With the exception of feed rate adjustment, make all machine adjustments or maintenance with the machine disconnected from the power source. A machine under repair should be RED TAGGED to show it should not be used until the maintenance is complete.
13. Remove adjusting keys and wrenches. Form a habit of checking to see that keys and adjusting wrenches are removed from the machine before turning it on.
14. Keep safety guards in place at all times when the machine is in use. If removed for maintenance purposes, use extreme caution and replace the guards immediately.
15. Check damaged parts. Before further use of the machine, a guard or other part that is damaged should be carefully checked to determine that it will operate properly and perform its intended function. Check for alignment of moving parts, binding of moving parts, breakage of parts, mounting and any other conditions that may affect its operation. A guard or other part that is damaged should be properly repaired or replaced.
16. Provide for adequate space surrounding work area and non-glare, overhead lighting.
17. Keep the floor around the machine clean and free of scrap material, oil and grease.
18. Keep visitors a safe distance from the work area. **Keep children away.**



Warnings

19. Make your workshop child proof with padlocks, master switches or by removing starter keys.
20. Give your work undivided attention. Looking around, carrying on a conversation and “horse-play” are careless acts that can result in serious injury.
21. Maintain a balanced stance at all times so that you do not fall or lean against moving parts. Do not overreach or use excessive force to perform any machine operation. Stand to the side out of line with the table and make sure no one else is standing in line with the table.
22. Use the right tool at the correct speed and feed rate. Do not force a tool or attachment to do a job for which it was not designed. The right tool will do the job better and safer.
23. Maintain tools with care. Keep knife inserts sharp and clean for the best and safest performance. Follow instructions for lubricating machine and changing accessories. Use recommended accessories; improper accessories may be hazardous.
24. Do not attempt to plane boards shorter than 10” in length without butting a board of equal thickness behind it to help it through the planer. Be sure the last board of a butted sequence is 12” or longer.
25. Do not feed stacked boards through a planer; a kickback may occur causing severe or fatal injury.
26. Do not plane boards with loose knots or with nails or any foreign material on its surface. Twisted, warped, or wind-in stock should first be jointed on one surface before attempting to plane a parallel surface on the planer. Serious stock flaws cannot be removed by use of a planer alone.
27. Disconnect machine from power source before cleaning. Use a brush or compressed air to remove chips or debris — do not use your hands.
28. Do not stand on the machine. Serious injury could occur if the machine tips over.
29. Never leave the machine running unattended. Turn the power off and do not leave the machine until it comes to a complete stop.
30. Remove loose items and unnecessary work pieces from the area before starting the machine.

Familiarize yourself with the following safety notices used in this manual:



This means that if precautions are not heeded, it may result in minor injury and/or possible machine damage.



This means that if precautions are not heeded, it may result in serious injury or possibly even death.

- - SAVE THESE INSTRUCTIONS - -

Introduction

This manual is provided by WMH Tool Group covering the safe operation and maintenance procedures for a Powermatic Model WP2510 Planer. This manual contains instructions on installation, safety precautions, general operating procedures, maintenance instructions and parts breakdown. This machine has been designed and constructed to provide years of trouble free operation if used in accordance with instructions set forth in this manual. If there are any questions or comments, please contact either your local supplier or WMH Tool Group. WMH Tool Group can also be reached at our web site: www.wmhtoolgroup.com.

Specifications

Model Number.....	WP2510
Stock Number.....	1791303
Main Drive Motor	TEFC, 15HP, 3Ph, 230/460V (pre-wired 230V)
Table Hoist Motor	TEFC, 1/2HP, 3Ph
Maximum Cutting Width (in.).....	25
Maximum Cutting Thickness (in.).....	9
Full Width Cutting Depth (in.).....	1/8
Maximum Cutting Depth (in.)	1/4
Minimum Planing Length (in.)	10
Number of Knives, Helical Head	174 (four-sided carbide inserts)
Segmented Infeed Roll Diameter (in.)	3
Steel Outfeed Roll Diameter (in.)	2-1/2
Cutterhead Speed (RPM)	5,000
Cutterhead Diameter (in.)	3-3/8
Feed Rate (FPM).....	30-25-20
Table Size (L x W)(in.)	32-3/16 x 26
Dust Port Diameter (in.)	5
Shipping Weight (lbs.).....	1,760
Net Weight (lbs.).....	1,585
Overall Dimensions (L x W x H)(in.)	42 x 53-1/2 x 60

The above specifications were current at the time this manual was published, but because of our policy of continuous improvement, WMH Tool Group reserves the right to change specifications at any time and without prior notice, without incurring obligations.

Unpacking

Open shipping container and any smaller boxes and check for shipping damage. Report any damage immediately to your distributor and shipping agent. Do not discard any shipping material until the planer is installed and running properly.

Compare the contents of your container with the following parts list to make sure all parts are intact. Missing parts, if any, should be reported to your distributor. Read the instruction manual thoroughly for assembly, maintenance and safety instructions.

NOTE: To remove the box from atop the planer table, loosen the table lock handle, push in the elevating handwheel (see Figure 3) and rotate the handwheel to lower the table.

Contents of the Shipping Container

- 1 Planer
- 1 Dust Hood – (A)
- 1 RA-30E 460V Overload Relay – (B)
- 1 Handle with Knob – (C)
- 3 Open End Wrenches, 17-19, 22-24, and 12-14 mm – (D)
- 4 Foot Pads – (E)
- 4 Hex Wrenches, 3, 4, 5, and 8mm – (F)
- 1 Reversible Screwdriver – (G)
- 2 Star Point Screwdrivers – (H)
- 10 Replacement Knife Inserts – (J)
- 8 Lock Washers, M6 – (K)
- 8 Flat Washers, M6 – (L)
- 8 Button Head Socket Screws, M6x12 – (M)
- 10 Knife Insert Screws, #10-32 x 1/2" (N)
- 1 Operating Instructions and Parts Manual
- 1 Warranty Card

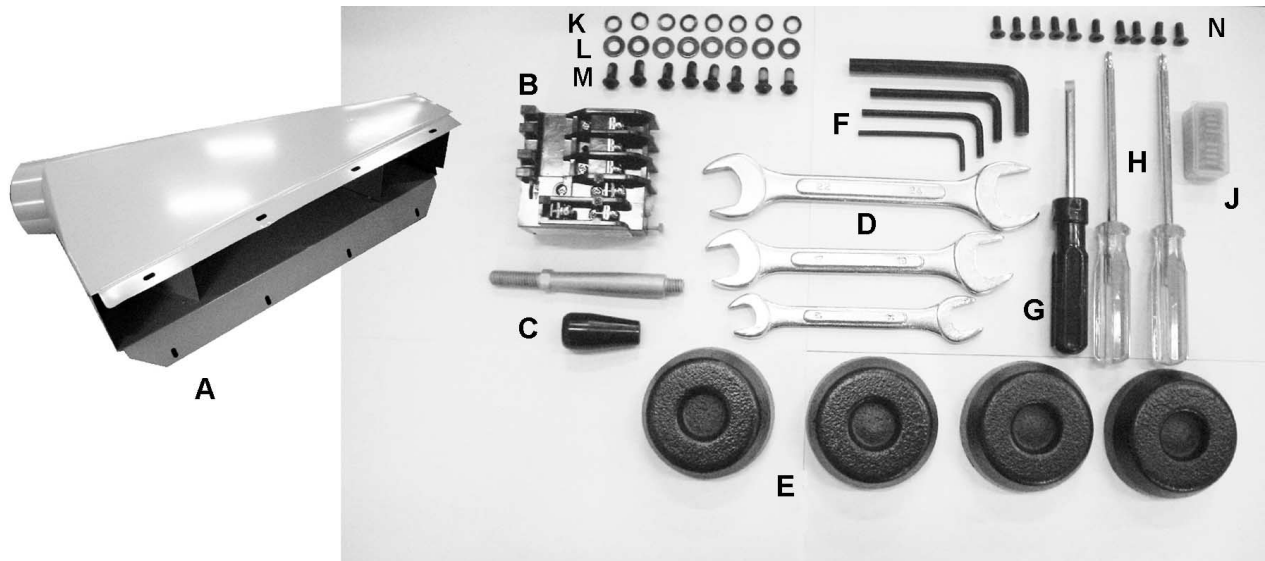

⚠ WARNING

Read and understand the entire contents of this manual before attempting set-up or operation! Failure to comply may cause serious injury.

Installation and Assembly

Tools Required for Installation:

Forklift or hoist, with lifting straps
4mm hex wrench (provided)
22mm combination wrench (provided)

Remove any straps or boards holding the planer to the pallet. Place straps under the four lifting hooks at front and back to raise the planer off the pallet and move it to location.

CAUTION Make sure the straps will not damage buttons or levers on the front of the planer.

The planer should be installed on a solid foundation, preferably a concrete floor. The machine area should be clean, dry, well ventilated, and well lit. Since planers can create noise problems, the site selection should be one which minimizes reverberant sound from walls, ceilings and other equipment. Electricals should be installed so that they are protected from damage and exposure. Be sure to properly ground the machine.

Lower the leveling screws, and place the four foot pads beneath the leveling screws. See Figure 1. Lower the machine slowly onto the foot pads. The screws can be turned as necessary until the planer table is level. Tighten the hex nuts against the base to secure the screw settings.

Exposed metal parts have been coated with a rust preventative. This should be removed with a soft cloth moistened with kerosene or a good commercial cleaner/degreaser. Do not use an abrasive pad, and do not get solvents near plastic parts or painted areas.

Dust Hood

Use a 4mm hex wrench to mount the dust hood to the planer with eight M6 x 12 button head socket screws, eight M6 lock washers and eight M6 flat washers, as shown in Figure 2.

It is strongly recommended that a dust collection system be used with this machine. It should be of sufficient volume for this size planer. If a dust collector is not used, the user is cautioned against the health hazard and the limitations in the OSHA regulation for employee or student exposure to dust particles.

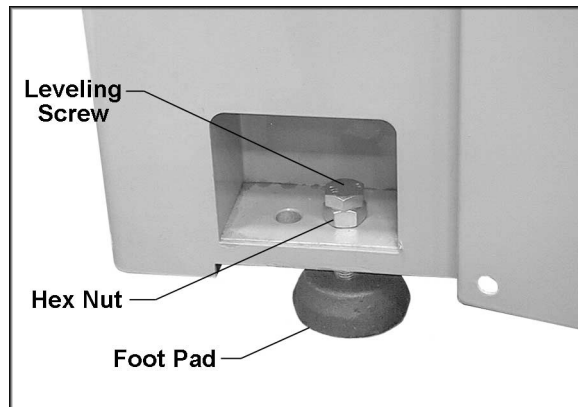

Figure 1

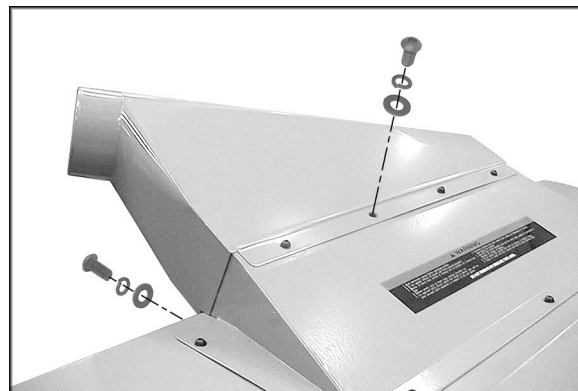

Figure 2

Grounding Instructions

⚠WARNING Electrical connections must be made by a qualified electrician in compliance with all relevant codes. This machine must be properly grounded to help prevent electrical shock and possible fatal injury.

This machine must be grounded. In the event of a malfunction or breakdown, grounding provides a path of least resistance for electric current to reduce the risk of electric shock.

Improper connection of the equipment-grounding conductor can result in a risk of electric shock. The conductor with insulation having an outer surface that is green with or without yellow stripes, is the equipment-grounding conductor. If repair or replacement of the electric cord or plug is necessary, do not connect the equipment-grounding conductor to a live terminal.

Check with a qualified electrician or service personnel if the grounding instructions are not completely understood, or if in doubt as to whether the tool is properly grounded.

Repair or replace a damaged or worn cord immediately.

Make sure the voltage of your power supply matches the specifications on the motor plate of the Planer. The machine should be connected to a dedicated circuit.

The use of an extension cord is not recommended for the WP2510 Planer.

230 Volt Operation

The Planer is factory wired for 230 volt, but can be converted to 460 volt if so desired (see "Converting From 230 Volt to 460 Volt"). You may either install a plug or "hard-wire" the Planer directly to a control panel.

If you are connecting a plug, use a proper UL/CSA listed 3-pole, 4-wire grounding plug suitable for 230 volt operation.

If the Planer is to be hard-wired to a panel, make sure a disconnect is available for the operator.

During hard-wiring of the Planer, make sure the fuses have been removed or the breakers have been tripped in the circuit to which the Planer will be connected. Place a warning placard on the fuse holder or circuit breaker to prevent it being turned on while the machine is being wired.

Converting from 230 Volt to 460 Volt

Consult the diagrams on pages 54 and 55 for specific information on the following changes.

1. Disconnect machine from power source.
2. Change the lead connections to the main motor and to the table hoist motor.
3. Replace the RA-30 (230V) overload relay with the provided RA-30E (460V) overload relay.
4. Switch the “R” wire on the transformer from the 230V to the 460V terminal.
5. If using a plug, install a proper UL/CSA listed plug suitable for 460V operation.

Test Run

After wiring has been completed, confirm that the wires have been connected properly:

1. Connect machine to power source and press the “Main Motor” button for just an instant, then press the Stop button.
2. The cutterhead should rotate clockwise as viewed from the handwheel side of the machine. If cutterhead rotation is incorrect, **disconnect machine from power source** and switch any two of the three wires at “R,S,T” (see “Electrical Connections”, pages 54 and 55).
3. Re-connect machine to power source.

Controller Set-Up

To program settings in the Controller for table movement, refer to the section beginning on page 20.

Adjustments

Depth of Cut

Depth of cut is adjusted by raising or lowering the table using the elevating handwheel or the push buttons for rough positioning; or the keypad on the Controller. The Controller is used for very precise positioning and for remembering your settings (for more information on the Controller see the section beginning on page 20).

To move the table with the elevating handwheel (Figure 3), push the handwheel *in* to engage the sprocket on the table elevating mechanism. One revolution of the handwheel equals 1/32” change in table height. Use the scale or digital readout to determine distance from the cutterhead.



Figure 3

Feed Rate

The planer is equipped with selectable feed rate rollers that feed stock at 20, 25 or 30 feet per minute. To adjust speed, rotate the lever shown in Figure 4.

IMPORTANT: Change feed rate only while the machine is running.

Belt Tension

1. Disconnect machine from power source.
2. Remove the lower rear panel and use the four hex nuts on the motor mount to adjust belt tension. See Figure 5. Adjust motor plate up or down until correct belt tension is achieved. To lower the motor plate, loosen lower nuts and tighten upper nuts. To raise the motor plate, do the opposite.
3. Correct tension is obtained when there is approximately 1/4" deflection in the center span of the belt using light finger pressure.
4. Re-tighten hex nuts and install lower rear panel.

Opening Hood

To open the hood for access to the cutterhead, remove the two shoulder screws (Figure 4).

NOTE: The planer has a limit switch which prevents operation while the hood is open.

Replacing or Rotating Knife Inserts

⚠WARNING Knife inserts are extremely sharp. Use caution when working with or around the cutterhead.

The knife inserts on the model 15HH are four-sided. When dull, simply remove each insert, rotate it 90° for a fresh edge, and re-install it.

Use the provided star point screwdrivers to remove the knife insert screw. See Figure 6. One screwdriver can be used to help hold the cutterhead in position while the other one is used to remove the screw.

It is advisable to rotate all inserts at the same time to maintain consistent cutting. However, if one or more knife inserts develops a nick, rotate only those inserts that are affected.

Each knife insert has an etched reference mark so you can keep track of the rotations.

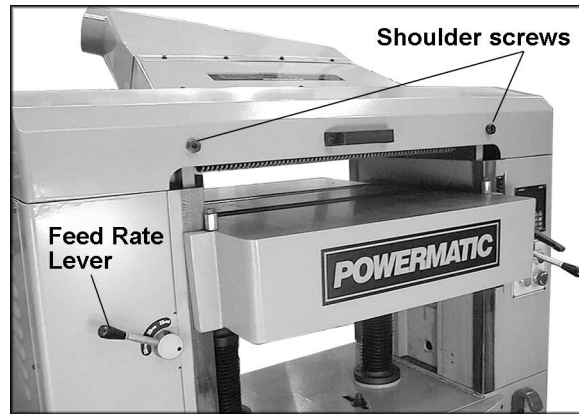

Figure 4

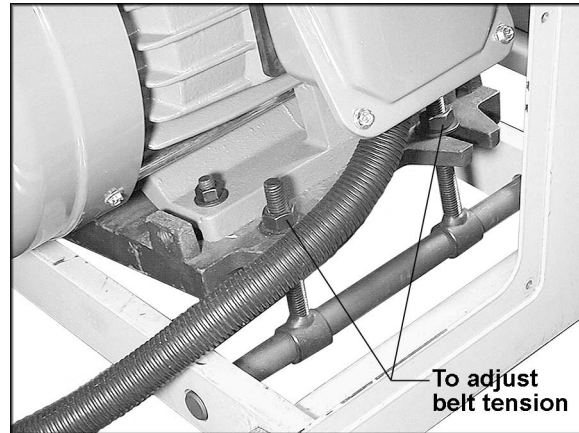

Figure 5

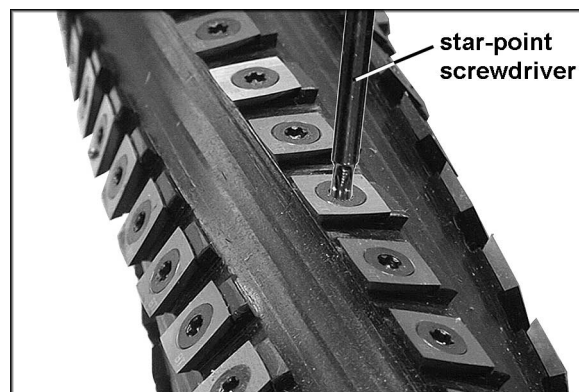

Figure 6

IMPORTANT: When removing or rotating inserts, clean saw dust from the screw, the insert, and the cutterhead platform. Dust accumulation between these elements can prevent the insert from seating properly, and may affect the quality of the cut.

Before installing each screw, lightly coat the screw threads with machine oil and wipe off any excess.

Securely tighten each screw which holds the knife inserts before operating the planer!

⚠WARNING Make sure all knife insert screws are tightened securely. Loose inserts can be propelled at high speed from a rotating cutterhead, causing injury.

The Planer's Feed System

(Figure 8)

1. Anti-Kickback Fingers
2. Infeed Roller
3. Chipbreaker
4. Cutterhead
5. Pressure Bar
6. Outfeed Rollers

Anti-Kickback Fingers

Anti-kickback fingers help prevent stock from being thrown from the machine. These fingers operate by gravity and should be inspected for pitch or gum buildup before each day's use. The fingers must operate freely and move independently for correct operation.

Infeed Roller

The function of the infeed roller is to feed the material into the machine. It is a corrugated, sectional roller with approximately 1/4" independent movement of each section to accommodate multiple board surfacing.

To provide proper drive, the infeed roller should be set so that the bottom of its arc is 1/16" below the arc of the cutterhead knife inserts. The infeed roller is under spring tension and this tension must be sufficient to feed the stock uniformly through the planer without slipping but should not be so tight that it causes damage to the boards. The tension should be equal at both ends of the roller.

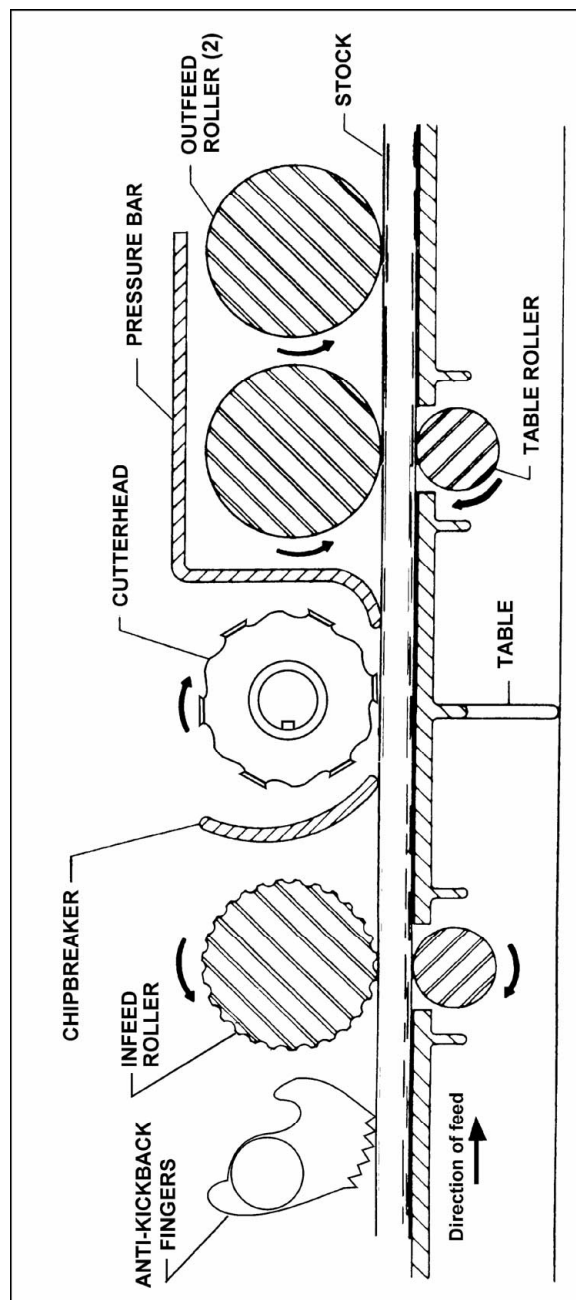

Figure 8

To adjust the infeed roller:

1. Disconnect machine from power source.
2. Place a dial gauge under a knife insert in the cutterhead. (Figure 9 shows a Bed and Feed Roll Gauge – accessory #2230002 – which can be purchased from your dealer.)

If a dial gauge is not available, use a finished block of wood with notches cut out for the table rollers, in conjunction with a feeler gauge. See Figure 10 for an example of a wood block you can make and use as a gauge.

3. Raise the table with the handwheel until the gauge contacts a knife insert at the apex of its curve. Zero the gauge at that position.
4. Move the gauge to the extreme left side of the infeed roller and check the measurement. It should be $1/16$ " below the knife measurement.
5. If it is not $1/16$ ", correct by loosening the hex nut (A, Figure 11) and turning the adjustment screw (B, Figure 11) with a hex wrench.
6. Move the gauge to the extreme opposite end of the infeed roller and check. Make necessary adjustments. Tighten hex nuts (A, Figure 11) when finished.

IMPORTANT: The setting on both sides of the infeed roller must be the same to avoid skewing of the material as it is fed through the machine.

Chipbreaker

The chipbreaker (C, Figure 11) is a sectionalized type made of spring-loaded sections mounted on a bar, which complements the sectional infeed roller. The functions of the chipbreaker are to break chips into small pieces, help avoid splintering of the wood, help avoid board bounce on thinner boards, to direct the flow of chips out of the machine, and to permit multiple board surfacing.

The chipbreaker has been factory set at $1/32$ " below the cutting arc of the knives, and has been spring-tensioned properly.

CAUTION A chipbreaker set too low or with excessive tension may prevent stock from feeding into the machine.

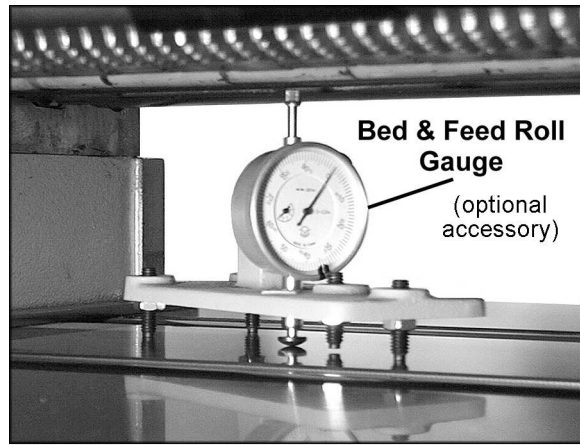

Figure 9

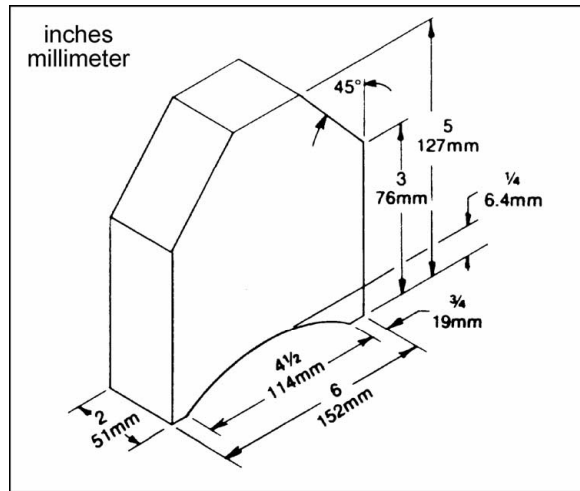

Figure 10

User-made Gauge Block

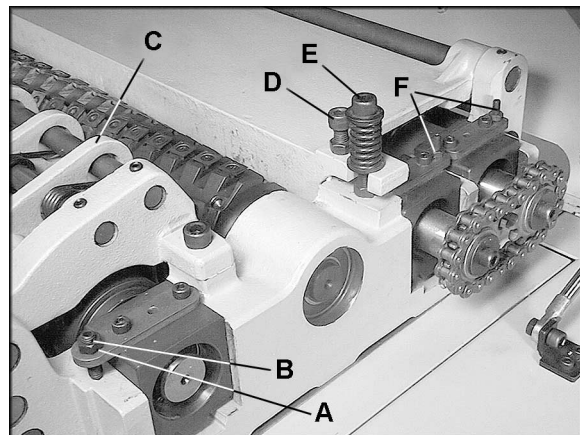

Figure 11

Pressure Bar

Most planing problems can be traced to improper setting of the pressure bar. Its function is to hold down the material after it passes under the cutterhead and throughout the remainder of the cut. Its basic setting is to be in line with the arc of the cutterhead knives.

If it is too high, a shallow “clip” will occur at each end of the board. If it is too low, stock will not feed through.

Use a gauge to set the full length of the pressure bar to be .000-.001” (.02mm) below the arc of the cutterhead. Figure 11 shows the height adjustment screw (D) and the spring tension adjustment screw (E) for the pressure bar. This initial setup is a starting point and final adjustment may have to be made during a test cut.

Outfeed Rollers

The two outfeed rollers are of smooth, one-piece construction to help avoid marring the finished surface of the material being cut. Their function is to continue to feed the material through the machine after it leaves the infeed roller. The correct free position setting is 1/32” (.8mm) below the arc of the cutterhead knives.

Use a gauge, such as a bed and feed roll gauge or wood gauge block, to check the outfeed rollers in the same manner as the infeed roller.

Adjust as necessary using the screws (F, Figure 11). When finished adjusting, tighten the hex nuts on the screws (F, Figure 11).

Table Rollers

The Planer has two table rollers which help reduce friction of the stock on the table as it feeds through the machine. It is not possible to give exact height setting of the table rollers because each type of wood behaves differently. As a general rule, however, the table rollers should be set high when planing rough stock, and set low for finish cuts.

The planer is equipped with a quick-set table roller adjustment. With a single lever, you can raise the rollers from their finishing board height to a roughing board height. See Figure 12. The range is 0.00 to 0.05”.

To adjust the height of the table rollers, loosen the lock handle (Figure 12) and turn the quick-set lever. Re-tighten the lock handle to lock the setting.

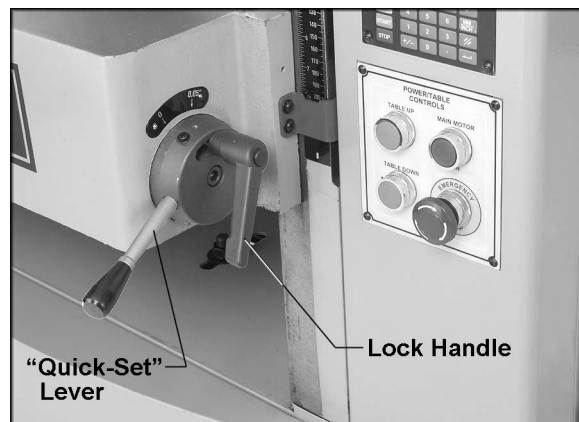

Figure 12

The table rollers are adjusted at the factory. If they should need further or “fine” adjustment:

1. Disconnect machine from power source.
2. Loosen lock handle and position the quick-set lever (Figure 12) to zero.
3. Use a dial gauge (not provided) to find the distance from table top to the apex of the table roller. Zero the gauge at this position.
4. Place the gauge over the extreme right side of the table roller and find the high point of the table roller arc. The gauge should still read zero.
5. If the gauge reading is greater or less than zero, reach beneath the table with a wrench and loosen the hex nut (C, Figure 13) which is above the cam (D, Figure 13) near the end of the roller that needs adjusting. Rotate the hex cap screw (E, Figure 13) until the gauge reads zero.
6. Repeat the process for the left side of the table roller, and then recheck the right side. It is important that both ends of the table rollers be the same height to help prevent skewing of the board as it feeds through the machine.
7. Re-tighten the hex nuts (C, Figure 13) on both ends of the table roller.
8. Repeat the procedure for the second table roller.

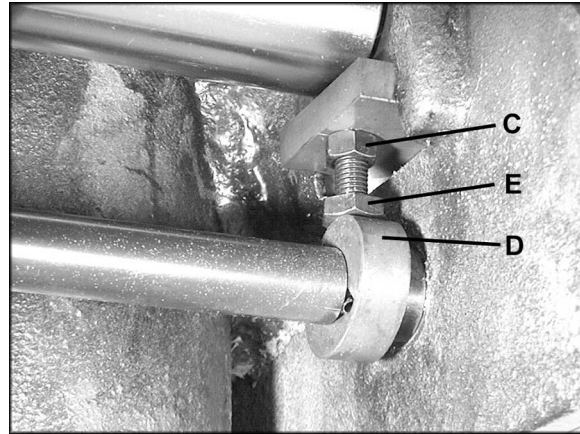

Figure 13

Table Adjustments

The planer table is raised and lowered by twin screws supported on bearings, and is guided by machined surfaces on the side panels. The fit-up to prevent the table from rocking is controlled by gibs. See Figure 14. These gibs should be adjusted individually using the three gib screws provided so that the ways are lightly contacting on all four surfaces. The gibs should be tight enough to prevent rocking or movement of the table when the planer is in operation.

To perform accurate planing the table must be parallel with the cutterhead. Lack of parallelism results in a taper over the width of the board. To check parallelism do the following:

1. Place a gauge on the table and contacting a knife insert at the apex of its arc, Do this at each end of the cutterhead and compare the measurements.
2. If the table is not parallel to the cutterhead, place the gauge at the end that needs to be raised.

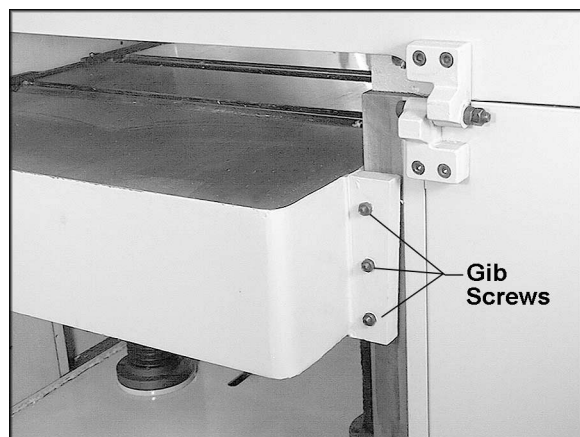

Figure 14

3. Loosen the three socket head cap screws (A, Figure 15) beneath the table.
4. Place a rod-like object (such as a hex wrench) into one of the open holes (B, Figure 15) and turn the shaft (C, Figure 15) to raise the table until the gauge reads the proper measurement. Or, the same effect can be achieved by lowering the other side of the table.
5. Re-tighten the socket head cap screws (A, Figure 15).

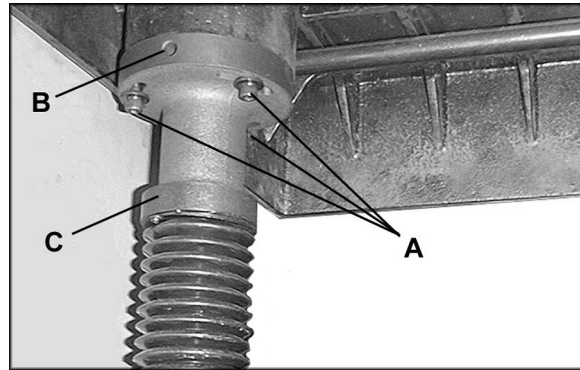

Figure 15

Test Cutting and Troubleshooting

Using a piece of semi-finished stock, set up for a 1/16" (1.59mm) deep cut with the quick-set table roller setting at zero. Start the machine and, standing to one side of the table, begin feeding the stock into the machine.

⚠WARNING Never stand directly behind stock or allow anyone else to do so, and do not bend down to see how stock is feeding. Should a kickback occur, serious or fatal injury could result.

The infeed roller should take the material and force it under the chipbreaker and cutterhead. If the material feeds through effortlessly, examine the finished cut carefully for imperfections.

Learning to read a board for imperfections will save hours in adjusting a planer to operate properly.

Following are some problems that may arise and their probable remedies. The illustrations are exaggerated for clarity. (Pages 36-38 also contain Troubleshooting remedies).

Feed Restriction

This is caused either by the table rollers being set too low for roughing operations or from a low pressure bar. About 90 percent of the time, the pressure bar is too low. As the sharp edge of the knife inserts wear, you must compensate for this wear by slightly raising the pressure bar an equal amount on each side. Your first indication of knife wear is hesitation in feed of the material through the machine after it leaves the corrugated infeed roller on its way out of the machine. **Disconnect machine from power** and adjust the pressure bar accordingly. The material will free up and feed through smoothly when the planer is restarted.

⚠CAUTION Never attempt pressure bar adjustment while the machine is connected to power.

Feed restriction can also occur due to pitch buildup on the table. Be sure the table surface is clean. Dusting the surface with talc occasionally will aid in smoother feeding and help prevent pitch buildup.

Clip Marks

If clip marks occur 6" (152mm) in from each end of the board, the pressure bar is too high. See Figure 16. Turn both right and left hand adjusting screws (see Figure 11) the same amount, 1/4 turn clockwise or less, and take another 1/16" (1.59mm) deep cut. Re-examine the board.

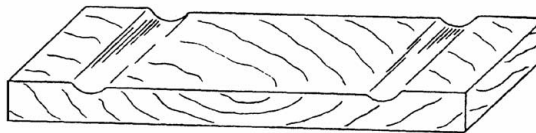

Figure 16
(clip marks)

Continue the operate-adjust procedure until the clip marks disappear. Should the board fail to feed through, back off slightly on both adjusting screws until feeding is smooth and the imperfections do not re-appear. Lock the pressure bar adjusting screws with the jam nuts provided.

Snipe

Some amount of snipe may be inevitable with many planer operations, but proper planer adjustments can so minimize snipe as to make it negligible.

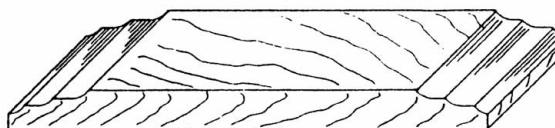

Figure 17
(snipe)

If noticeable snipes appear on each end of the material, as shown in Figure 17, a table roller is too high causing a slight lift of the material as it passes through the machine. Normally these snipes are more noticeable on the trailing end of the board than on the lead end, and most often occur during planing of rough lumber.

Table rollers must be elevated for running rough or resaw lumber through the machine. When material is turned over to surface the other side, and you neglect to lower the table rollers for a finish cut, then definite snipes will appear on the ends of the material.

Chatter

Chatter marks usually appear on thin material. See Figure 18. Even at their lowest point, the table rollers are too high to handle thin material. Solve the problem by either using a slave board or making an auxiliary table out of Formica countertop material with cleating at each end of the table to keep it stationary over the planer table.

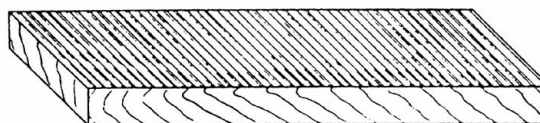

Figure 18
(chatter)

Tapers

If the machine planes a taper across the full width of the board, as shown in Figure 19, the table is not parallel with the cutterhead. First check that all knife inserts are properly installed. If they are, then the table itself must be adjusted. See "Table Adjustments" on page 16.

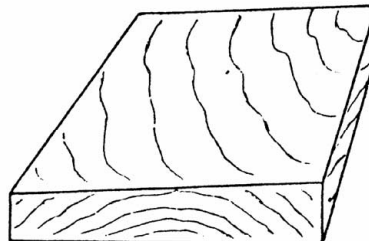

Figure 19
(taper)

Twisting

If material twists while feeding through the planer, either the table rollers, pressure bar, or outfeed roller may be out of level. Refer to adjustment settings on pages 14 and 15.

Halted Feeding

If the infeed roller takes the stock, the chipbreaker lifts, and just as you hear the knives contact the material, the workpiece stops feeding; then the pressure bar is too low. Re-set the pressure bar (see page 15).

Operation

NOTE: For detailed explanation of the Controller, refer to the section beginning on page 20.

The emergency stop button shuts down all operations on the planer. To re-start the planer, twist the knurled ring on the stop button until it pops back out.

Maintenance

Periodic inspections are required to ensure that the machine is in proper adjustment, that all screws are tight, that belts are in good condition, that dust has not accumulated in the electrical enclosures, and that there are no loose or worn electrical connections.

Buildup of sawdust and other debris can cause your machine to plane inaccurately. Periodic cleaning is not only recommended but mandatory for accurate planing.

Close fitting parts, such as the link plates below the table and the platforms on the cutterhead which seat the knife inserts, should be cleaned with a rag or brush and non-flammable solvent and freed from clinging foreign matter.

⚠WARNING Use caution when working with or around the cutterhead.

Remove resin and other accumulations from feed rollers and table with a non-flammable solvent.

Lubrication

The gear box oil should be changed at least once a year. Remove the drain plug (A, Figure 20) to drain the oil into an appropriate container. Replace the drain plug and fill the gear box with 60-90 weight gear oil through the fill hole (B, Figure 20). The sight glass (C, Figure 20) should be checked periodically and oil topped off as necessary.

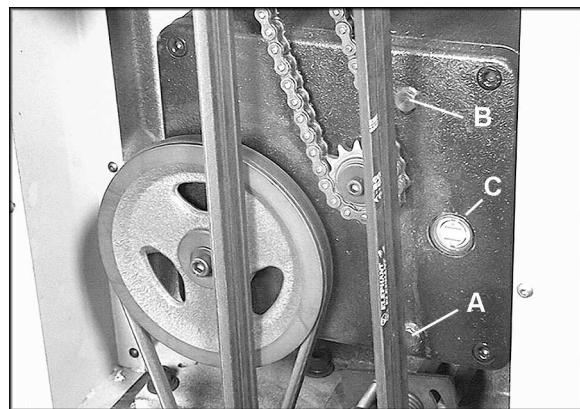

Figure 20

The recommended lubrication for roller chains used in medium to slow speed operation is to simply wipe the chain clean. When there is an appreciable buildup of dust, dirt or wood shavings, use an oil cloth but never pour the oil directly on the chain. Over-oiling defeats the purpose of the lubrication, since it tends to invite the collection of dust, shavings, etc. and works into members of the chain. This hastens wear and leads to premature replacement.

The bearings on the cutterhead and feed rollers are factory lubricated and sealed. They require no further attention.

Controller (M15S) Operating Instructions

1. Front Panel Overview

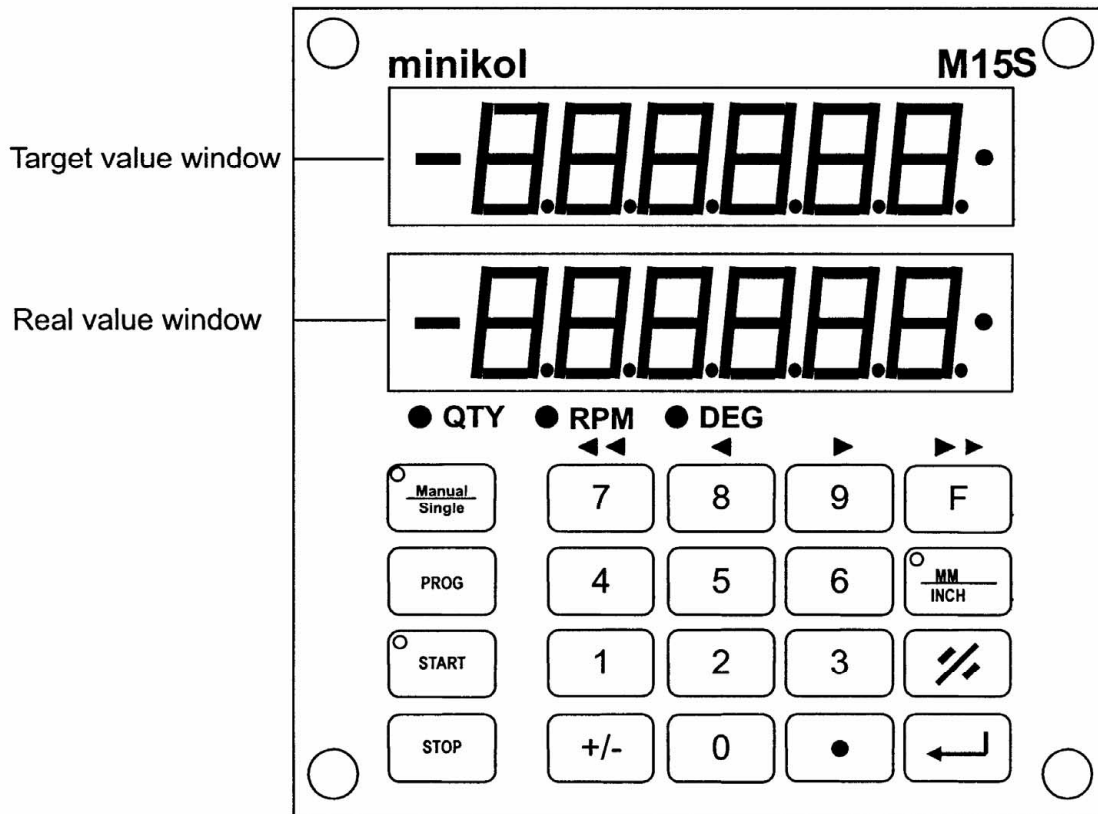

2. Operation Modes

There are two base operating modes – MANUAL and SINGLE.

In MANUAL mode, the operator can raise or lower the table using the Controller keypad.

In SINGLE mode, the table will move to the pre-set value when you push the “Table Up” or “Table Down” buttons on the planer’s control panel.

Press  to select Manual mode or Single mode:

When  LED lamp is on – Manual mode.

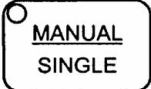
When  LED lamp is off – Single mode.

MANUAL MODE

Keyboard Function:

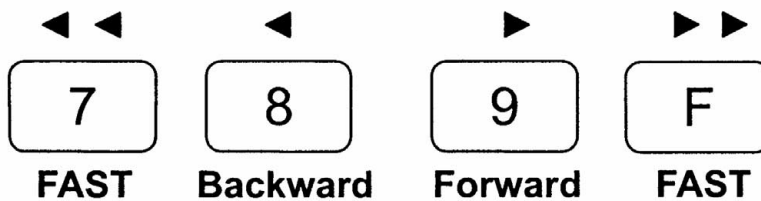

For planer table operations, the fast forward and fast backward keys have the same function as the forward and backward keys.

When the forward key is pressed, the planer table moves down. (This is also achieved using the “Table Down” push button on the planer).

When the backward key is pressed, the planer table moves up. (This is also achieved using the “Table Up” push button on the planer).

In Manual Mode, the planer table moves as long as a key is pressed and held. When the key is released, the table stops.

This mode can be used for manual positioning, or adjusting procedures.

SINGLE MODE

In single mode, the device performs automatic positioning of the table to the programmed target position. The “Table Up” or “Table Down” button on the planer should be pushed and held; when the table has fully adjusted to the target position, the table will automatically stop in position. Release the push button.

Setting Target Value

Step 1: Press  (Target window LED starts blinking)

Step 2: Enter the target value using numerical keypad.

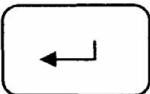



Step 3: Press  to complete.

 LED lamp starts blinking – the device is ready to start the positioning.

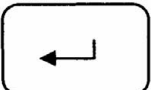

Start/Stop/Cancel

Press  to start the positioning. The LED lamp now stops blinking and remains on during the procedure.

Press  to cancel the positioning. The LED lamp is turned off.

If the  key is pressed while the positioning is running, the procedure is interrupted, the machine is stopped, and the  LED is turned off. To repeat the positioning of the same target, press   .

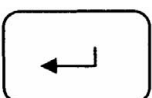
To program another target value, press

 - enter new value -  .

Example:

Assume:

target value on display = 100.00mm

real value on display = 100.00mm

To change the target value to 20.25mm,

Step 1: Press , the LED lamp on Target window is blinking.

Display	1 0 0.0 0 	Target value
	1 0 0.0 0	Current value



Step 2: Enter new target value (example: 20.25mm)

Press     

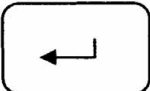
Display	2 0.2 5 	Target value
	1 0 0.0 0	Current value

Step 3: Press  to complete.

The  LED lamp is blinking – ready for positioning.

Press  to start the positioning or press  to cancel.

3. Fast Program (10 sets)

To facilitate frequently used positions, such as different board thicknesses, the keys 0 to 9 have associated preset target values. By pressing one of these keys, its target value is loaded automatically, and the positioning can be started immediately.

Entering preset target values:

Step 1: Press    

Step 2: Select a key 0 to 9 (total of 10 values).

Step 3: Enter the target value.

Step 4: Press  to confirm.



Follow the same procedure for entering the other preset target values.

Press  to exit.

Example: Program 0 = 10.00mm; Program 1 = 20.00mm

Step 1: Press    

Display

P r o G	—	
		

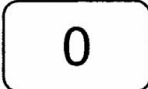
Step 2: Press  [select program key 0]

Step 3: Press   [enter value]

Step 4: Press  [complete]

Step 5: Press [select program key 1]

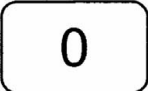
Step 6: Press  [enter value]

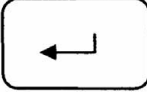
Step 7: Press [complete]

Step 8: Press  to exit.

Execute:

Step 1: Enter single mode,  LED lamp is off.

Step 2: Press a key 0 to 9.

 LED lamp is blinking, ready for start.

Example: Program 0 = 10.00mm; Program 1 = 20.00mm.

Step 1: In Single Mode,  LED lamp is off.

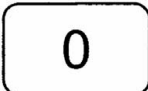
Step 2: Press [Program 0]

Now you will see the preset value: 10.00mm (Program 0)

 LED lamp is blinking, complete.

Press  to begin positioning.

4. Select Counting direction

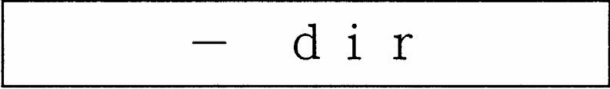

You can select the counting direction according to the table movement.

Step 1: Press   

Display [default]

Step 2: Press  to change the direction.

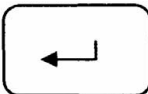
“-dir” numbers decrease as table rises (accords with scale on planer).
“dir-“ numbers increase as table rises.



Step 3: Press  to confirm or press  to clear.

5. Select Positioning Mode

Step 1: Press   

Step 2: Press  to select.

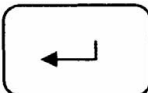
- a. ---| |--- both directions
- b. ---| left
- c. |--- right

Step 3: Press  to confirm or press  to clear.

6. Set Software Limit (Hi/Lo End)

There are High and Low software limits. If these are exceeded, the display will give an error message.

To set the Lo_End press    

To set the Hi_End press    

7. Set Tolerances

The tolerance defines the accuracy of the positioning.



Step 1: Press    

Display

t o l l
0.30

.....[default]

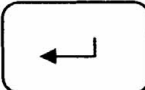
Step 2: Enter the value for tolerance.

Step 3: Press  to confirm or press  to clear.

8. Set Low Speed Limit

This function defines the speed level which is considered abnormal for the machine.

When the Controller starts the table movement up or down, and the table does not move, or moves with a speed lower than defined, it stops the machine and displays:

E n G i n E
F A u l t

Press  to clear.

To set low speed limit:

Step 1: Press    



Display

F A u l t
5 5

[default]

Step 2: Enter the low speed level 0 to 99

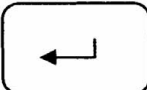
0 = Machine test is disabled
1 = very low
:
:
99 = high

Step 3: Press  to confirm or press  to clear.

9. Set Linear Correction



NOTE: Setting Linear Correction should be done in MM (metric) mode, not inches. This will ensure accurate readings for table movement.

Step 1: Press    

Display

l i n C o r
1 . 0 0 0 0 0

Step 2: Enter the value between 0.0001 and 9.9999



Step 3: Press  to confirm or press  to clear.

10. Enter Parameter Settings Mode

With this function, you can select each parameter to be locked or unlocked. When a parameter is locked, then the end-user can only see the value, but can not change it.

Step 1: Press    

Display

P A S S	
— — — —	

Step 2: Enter the password.

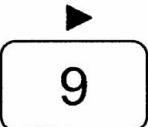
Step 3: Use  to scroll through the parameters.

Step 4: Press  to lock or unlock.

On = unlock
Off = lock

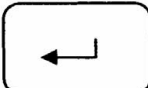
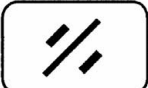
Step 5: Press  to confirm or press  to clear.

11. Check Software Version



To check the released version of the M15S Controller program:

Step 1: Press    

Display

S O U R C E
A C - 1 . 0 0

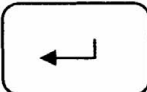
In the real value window, you will see the released version.

Step 2: Press  to confirm or press  to clear.

12. Load Datum Values

The real value refers to the distance between the machine table and the cutterhead. Thus, the cutterhead defines the zero point of the machine. It is, however, difficult or impossible to move the planer table to this point. Therefore, the zero point should be identified by either placing a gauge between table and cutterhead knife insert, or by planing a test board then measuring the board thickness with calipers. Program this real value into the Controller as follows.

Preset the real value:

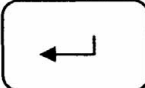
Step 1:   

Step 2: Enter the value.

Step 3: Press 

Load the real value:

Step 1: Press   

Display

CHAnGE	
OrG ??	



Step 2: Press  to confirm or press  to cancel.

Example:

The current value is 10.00mm but the actual thickness is 10.50mm.

Step 1: Press   

Display

Or i G i n	
0.00	

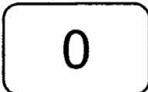
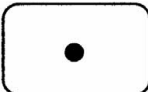
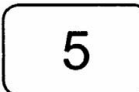
Step 2: Press    

Step 3: Press 

Step 4: Press   





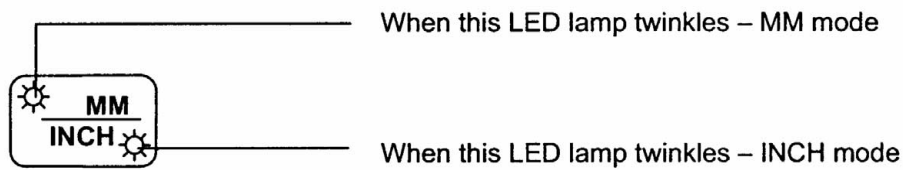



13. IN/MM Conversion



The dedicated mm/inch key allows for immediate switch of the units between millimeters and inches. The LEDs on the key indicate the selected unit. Switching between MM and INCHES has no effect on the control functions.



14. Set Device Resolution

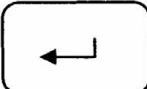

Step 1: Press    







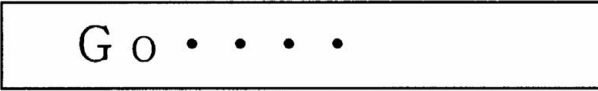

Step 2: Use          to select resolution.

Step 3: Press  to confirm or press  to clear.

15. Calibration

Step 1: Press    

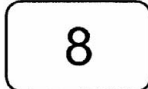
Display 

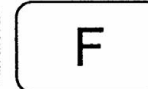

Step 2: Use          to move the planer table until

M15S terminates the calibration and restarts.

16. M15S Troubleshooting

Display 

“Change RST” message appears when the Controller detects a motion in the wrong direction. For example, the Controller switches the outputs to move upward but the table starts moving in the reverse direction. Usually this is caused by the wrong wiring of the three phase motor.

Press  to clear.

Check the wiring and change if necessary.

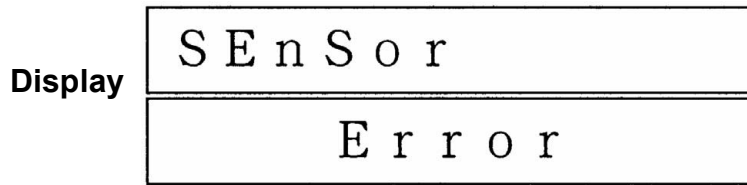

Possible cause:

- a. no sensor
- b. 9-pin connector is loose
- c. wire broken
- d. the gap between sensor and tape is too large

Excluding: Check the sensor, sensor cable and sensor connector.

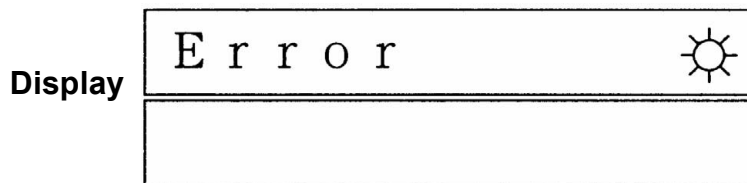

Possible cause: Incorrect operation.

Excluding: Press  to clear.

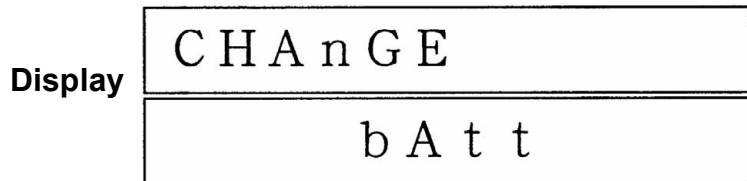

This message appears after power-on and indicates battery discharged. The C-type battery MUST be replaced to resume the operation of the device. Change as follows:

1. Open the planer's top right side panel to access the rear of the Controller.
2. Turn the power off. Be careful not to move the table during power off. Replace the battery and turn the power on. The device will resume normal operation.

17. M15S Specifications

Feature	Technical data	Additional information
Supply voltage	24 VDC 50mA	C type battery × 1
Battery voltage control	Yes	Low power alarm via display
Display	15mm LED × 6 digits × 2 line	
Output	4 digital output	AC250V / 7A AC110V/7A DC24V/10A
Input	4 digital input	24VDC
Operating elements	20 button keyboard	
Travel speed	1.5m/s	
System accuracy	± (0.025+0.02L)mm L: Meter	
Repeatability	0.01mm	
Temperature range	Working temperature 0+ 50°C	storage temperature -20+70°C
Humidity	max. 95% rF	Condensation not permitted

Troubleshooting: Planer Operating Problems

Trouble	Probable Cause	Remedy
Snipe.	Table rollers not set properly.	Adjust table rollers to proper height.
	Inadequate support of long boards.	Support long boards with a roller stand.
	Uneven feed roller pressure front to back.	Adjust feed roller tension.
	Dull knife inserts.	Rotate or replace knife inserts.
	Lumber not butted properly.	Butt end-to-end each piece of stock as they pass through.
Fuzzy grain.	Planing wood with a high moisture content.	Remove high moisture content from wood by drying, or use different stock.
	Dull knife inserts.	Rotate or replace knife inserts.
Torn grain.	Too heavy a cut.	Adjust proper depth of cut.
	Knife inserts cutting against grain.	Try to cut with the grain for finish cut.
	Dull knife inserts.	Rotate or replace knife inserts.
Rough/raised grain.	Dull knife inserts.	Rotate or replace knife inserts.
	Excessive depth of cut.	Decrease cutting depth.
	Moisture content too high.	Remove high moisture content from wood by drying, or use different stock.
Rounded, glossy surface.	Dull knife inserts.	Rotate or replace knife inserts.
Poor feeding of lumber.	Inadequate feed roller pressure.	Adjust feed roller tension. If proper tension cannot be achieved, replace feed rollers.
	Planer bed rough or dirty.	Clean off pitch and residue; apply light coat of paste wax to planer bed.
	V-belts are slipping.	Check V-belt tension and make any needed adjustments.
	Surface of feed rollers has been worn too smooth.	Lightly roughen the feed roller surface with sandpaper.

Troubleshooting: Mechanical and Electrical Problems

Trouble	Probable Cause	Remedy
Uneven depth of cut side to side.	Knife inserts not set correctly.	Make sure knife inserts are set correctly and securely in cutterhead.
	Planer table not level with cutterhead.	Level the table. See pages 16-17.
Board thickness does not match depth of cut scale.	Depth of cut scale is incorrect.	Adjust depth of cut scale. Use LED control panel for greater precision.
Chain is jumping.	Inadequate chain tension.	Adjust chain tension.
	Sprockets misaligned.	Align sprockets.
	Sprockets worn.	Replace sprockets.
Machine will not start/restart or repeatedly trips circuit breaker or blows fuses.	No incoming power.	Verify machine is connected to power.
	Stop button is still engaged.	Rotate stop button to disengage.
	Overload automatic reset has not reset.	When the planer overloads on the circuit breaker built into the motor starter, it takes time for the machine to cool down before restart. Allow machine to adequately cool before attempting restart. If problem persists, check amp setting on the motor starter inside the electrical box.
	Planer frequently trips.	One cause of overload trips which are not electrical in nature is too deep a cut. The solution is to take a lighter cut. If too deep a cut is not the problem, check the amp setting on the overload relay. Match the full load amps on the motor as noted on the motor plate. If amp setting is correct, then there is probably a loose electrical lead or a failed component. See items below.
	Building circuit breaker trips or fuse blows.	Verify that planer is on a circuit of correct size. If circuit size is correct, there is probably a loose electrical lead. Check amp setting on motor starter.
	Loose electrical connections.	Go through all of the electrical connections on the planer including motor connections, verifying the tightness of each. Look for any signs of electrical arcing which is a sure indicator of loose connections or circuit overload.

Trouble	Probable Cause	Remedy
Machine will not start/restart or repeatedly trips circuit breaker or blows fuses.	Motor starter failure.	<p>Examine motor starter for burned or failed components. If damage is found, replace motor starter. If motor starter looks okay but is still suspect, you have two options: have a qualified electrician test the motor starter for function, or purchase a new starter and establish if that was the problem on changeout.</p> <p>If you have access to a voltmeter, you can separate a starter failure from a motor failure by first, verifying incoming voltage at 220+/-20 and second, checking the voltage between starter and motor at 220+/-20.</p> <p>If incoming voltage is incorrect, you have a power supply problem.</p> <p>If voltage between starter and motor is incorrect, you have a starter problem.</p> <p>If voltage between starter and motor is correct, you have a motor problem.</p>
	Motor failure.	If electric motor is suspect, you have two options: Have a qualified electrician test the motor for function or remove the motor and take it to a quality electrical motor repair shop and have it tested.
	Miswiring of the machine.	Double check to confirm all electrical connections are correct. Refer to appropriate wiring diagrams on pages 54 and 55 to make any needed corrections.
	Switch failure.	If a start, stop, or table movement switch is suspect, you have two options: Have a qualified electrical test the switch for function, or purchase a new switch and establish it that was the problem on changeout.
Planer does not come up to speed.	Low current.	Contact a qualified electrician.

Replacement Parts

Replacement parts are listed on the following pages. To order parts or reach our service department, call 1-800-274-6848 Monday through Friday (see our website for business hours: www.wmhtoolgroup.com). Having the Model Number and Serial Number of your machine available when you call will allow us to serve you quickly and accurately.

Column Assembly

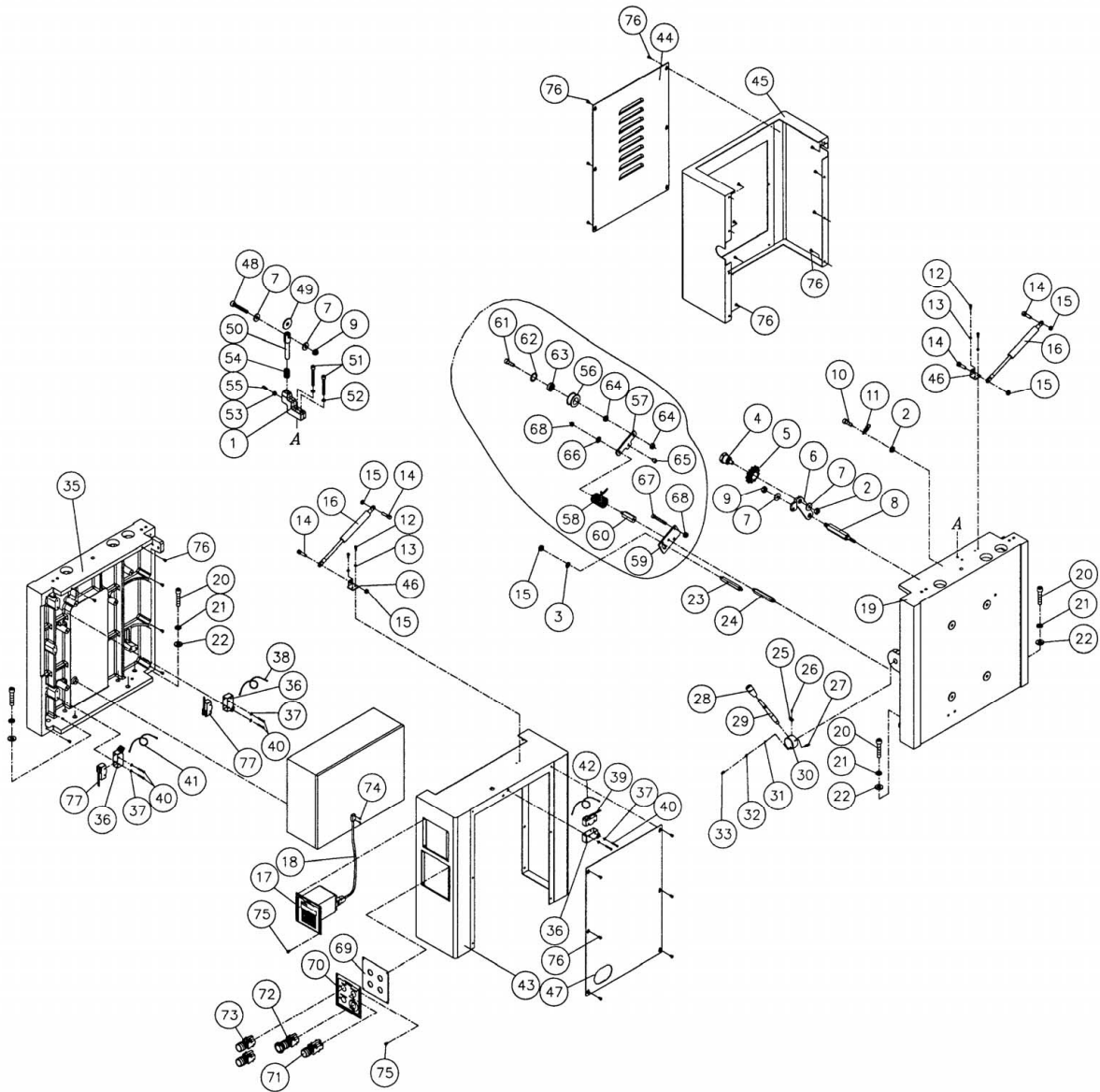

Parts List: Column Assembly

Index No.	Part No.	Description	Size	Qty
1	WP2510-401	Idler Support Base		1
2	TS-1540071	Hex Nut	M10	2
3	TS-1550061	Flat Washer	M8	1
4	6012082	Shaft		1
5	6012286	Sprocket		1
6	6012287	Sprocket Bracket		1
7	TS-1550071	Flat Washer	M10	4
8	WP2510-408	Shaft		1
9	TS-1541041	Nylon Insert Lock Nut	M10	2
10	TS-1505071	Socket Head Cap Screw	M10x45	1
11	WP2510-411	Spring		1
12	TS-1502031	Socket Head Cap Screw	M5x12	4
13	TS-1551031	Lock Washer	M5	4
14	WP2510-414	Shoulder Screw		4
15	TS-1541031	Nylon Insert Lock Nut	M8	4
16	WP2510-416	Cylinder		2
17	WP2510-417	Controller		1
18	WP2510-418	Cord		1
19	WP2510-419	Left Column		1
20	TS-1506051	Socket Head Cap Screw	M12x40	12
21	TS-1551081	Lock Washer	M12	12
22	TS-2360121	Flat Washer	M12	12
23	WP2510-423	Shaft		1
24	WP2510-424	Shaft		1
25	WP2510-425	Pointer		1
26	TS-2171012	Pan Head Screw	M4x6	1
27	WP2510-427	Pin		1
28	6012214	Handle Knob		1
29	6012213	Handle Shaft		1
30	WP2510-430	Shift Hub		1
31	WP2510-431	Steel Ball		1
32	WP2510-432	Spring		1
33	TS-1524031	Set Screw	M8x12	1
35	WP2510-435	Right Column		1
36	WP2510-436	Plastic Cover		3
37	TS-1550021	Flat Washer	M4	6
38	WP2510-438	Limit Switch Cord	18AWG x 2C x 750mm	1
39	WP2510-439	Limit Switch		1
40	TS-2284302	Pan Head Screw	M4x30	6
41	WP2510-441	Limit Switch Cord	18AWG x 2C x 400mm	1
42	WP2510-442	Limit Switch Cord	18AWG x 2C x 900mm	1
43	WP2510-443	Right Cover		1
44	WP2510-444	Left Panel		1
45	WP2510-445	Left Cover		1
46	WP2510-446	Cylinder Bracket		2
47	WP2510-447	Right Panel		1
48	TS-1505061	Socket Head Cap Screw	M10x40	1
49	WP2510-449	Washer		1
50	WP2510-450	Shaft		1
51	TS-1504081	Socket Head Cap Screw	M8x40	2
52	TS-1551061	Lock Washer	M8	2
53	TS-1540041	Hex Nut	M6	1
54	WP2510-454	Spring		1
55	TS-1523061	Set Screw	M6x20	1
	WP2510-IA	Idler Assembly (Items 56 thru 68)		1
56	WP2510-456	Idler		1
57	WP2510-457	Idler Bracket		1

58.....	WP2510-458.....	Spring.....	1
59.....	WP2510-459.....	Plate.....	1
60.....	WP2510-460.....	Bolt.....	1
61.....	TS-1505041.....	Socket Head Cap Screw.....	M10x30..... 1
62.....	WP2510-462.....	C-Ring.....	1
63.....	BB-6200ZZ.....	Ball Bearing.....	6200ZZ..... 1
64.....	TS-1540071.....	Hex Nut.....	M10..... 2
65.....	WP2510-465.....	Socket Head Cap Screw.....	M8x8..... 1
66.....	TS-1550061.....	Flat Washer.....	M8..... 1
67.....	TS-1504121.....	Socket Head Cap Screw.....	M8x60..... 1
68.....	TS-1540061.....	Hex Nut.....	M8..... 1
69.....	WP2510-469.....	Inner Plate.....	1
70.....	WP2510-470.....	Outer Plate (Controls).....	1
71.....	WP2510-471.....	Main Motor Pushbutton Switch.....	1
72.....	WP2510-472.....	Emergency Stop Pushbutton Switch.....	1
73.....	WP2510-473.....	Table Pushbutton Switch.....	2
74.....	WP2510-474.....	Screw.....	M3x15..... 2
75.....	TS-2244102.....	Button Head Socket Screw.....	M4x10..... 8
76.....	TS-2246102.....	Button Head Socket Screw.....	M6x10..... 28
77.....	WP2510-477.....	Limit Switch.....	2

Gearbox Assembly

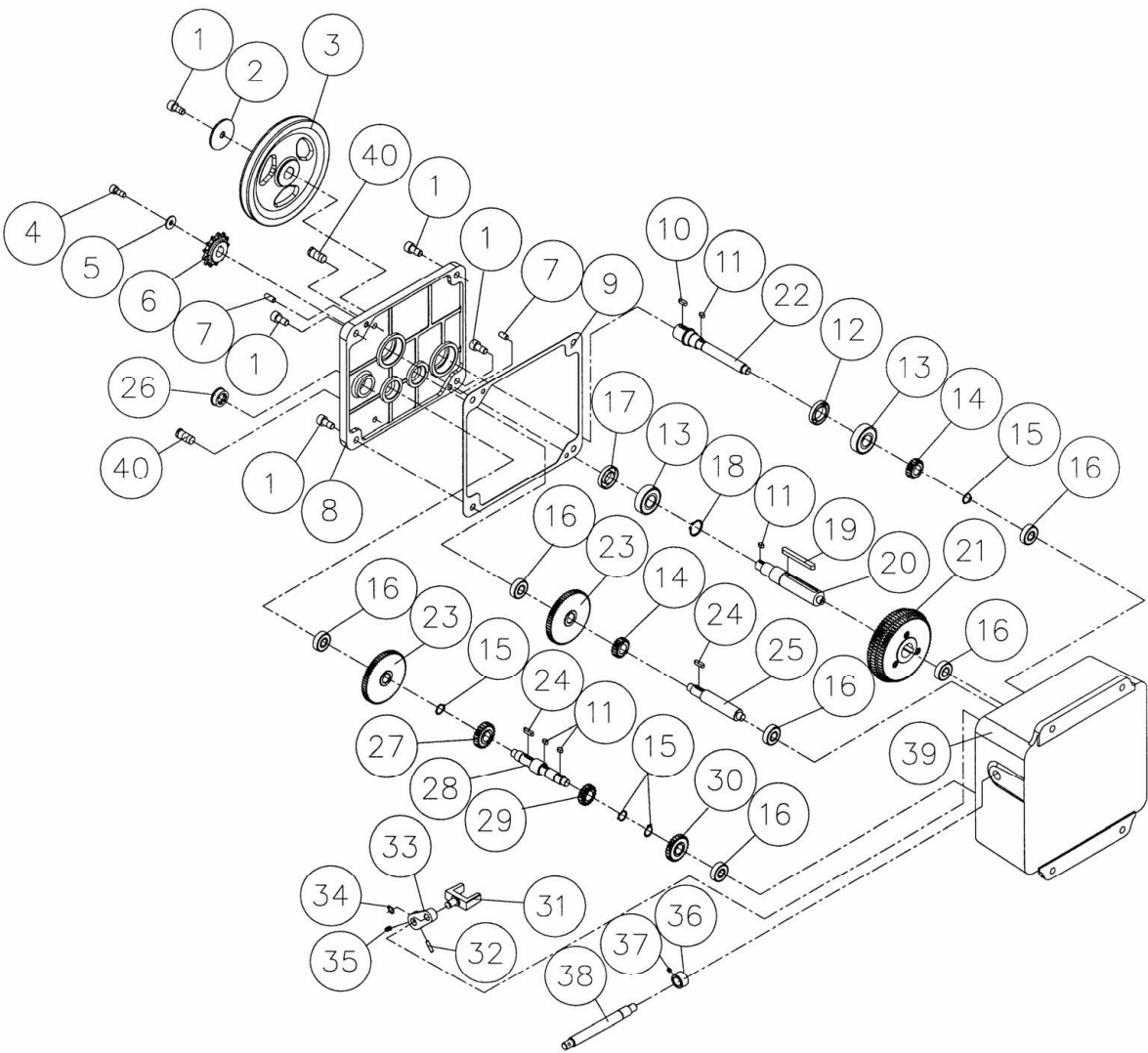

Parts List: Gearbox Assembly

Index No.	Part No.	Description	Size	Qty
	WP2510-100	Gearbox Assembly (index nos. 1 through 40)		1
1	TS-1505021	Socket Head Cap Screw	M10x20	5
2	6012047	Washer		1
3	6012046	Pulley		1
4	TS-1504041	Socket Head Cap Screw	M8x20	1
5	TS-1550061	Flat Washer	M8	1
6	6012050	Sprocket		1
7	WP2510-107	Pin		2
8	WP2510-108	Gearbox Cover		1
9	WP2510-109	Gasket		1
10	WP2510-110	Key	5x5x16	1
11	WP2510-111	Key	5x5x10	4
12	WP2510-112	Oil Seal		1
13	BB-6204VV	Ball Bearing	6204VV	2
14	6012037	Gear	20T	2
15	WP2510-115	S-Ring		4
16	BB-6201VV	Ball Bearing	6201VV	6
17	WP2510-117	Oil Seal		1
18	WP2510-118	S-Ring		1
19	WP2510-119	Key	8x7x72	1
20	WP2510-120	Shaft		1
21	WP2510-121	Gear		1
22	WP2510-122	Shaft		1
23	6012041	Gear	60T	2
24	WP2510-124	Key	5x5x20	2
25	WP2510-125	Shaft		1
26	WP2510-126	Oil Level Sight Glass		1
27	WP2510-127	Gear		1
28	WP2510-128	Shaft		1
29	WP2510-129	Gear		1
30	WP2510-130	Gear		1
31	WP2510-131	Shift Fork		1
32	WP2510-132	Pin		1
33	6012061	Lever		1
34	WP2510-134	S-Ring		1
35	TS-1523021	Set Screw	M6x8	1
36	WP2510-136	Bushing		1
37	TS-1523011	Set Screw	M6x6	1
38	WP2510-138	Shift Shaft		1
39	WP2510-139	Gearbox		1
40	WP2510-140	Oil Plug		2

Parts List: Cutterhead Assembly

Index No.	Part No.	Description	Size	Qty
1	WP2510-201	Socket Head Cap Screw	M10x75	2
2	TS-1550071	Flat Washer	M10	12
3	6012132	Spring		2
4	WP2510-204	Wave Washer		1
5	TS-1505061	Socket Head Cap Screw	M10x40	4
6	WP2510-206	Pressure Bar		1
7	TS-1540071	Hex Nut	M10	10
8	WP2510-208	Needle Bearing	NA-6906	6
9	WP2510-209	Set Screw	M6x30	6
10	TS-1540041	Hex Nut	M6	6
11	6012141	Bearing Housing		6
12	TS-1503041	Socket Head Cap Screw	M6x16	12
13	WP2510-213	Plate		6
14	WP2510-214	Rear Outfeed Roller		1
15	WP2510-215	Key	5x5x12	2
16	WP2510-216	C-Ring		6
17	6012177	Spacer		79
18	WP2510-218	C-Ring		6
19	WP2510-219	Sprocket		2
20	TS-1550061	Flat Washer	M8	3
21	TS-1504041	Socket Head Cap Screw	M8x20	2
22	WP2510-222	Key	8x7x35	2
23	WP2510-223	Front Outfeed Roller		1
24	WP2510-224	Socket Head Cap Screw (Left Thread)	M8x20	1
25	WP2510-225	Sprocket	22T	2
26	WP2510-226	S-Ring		1
27	WP2510-227	Ball Bearing	6210VV	2
28	WP2510-228	Bushing		1
29	WP2510-HCA	Helical Cutterhead Assembly (includes #29, 68, 69)		1
29	WP2510-829	Helical Cutterhead		1
30	BB-6008VV	Ball Bearing	6008VV	1
31	BB-6007VV	Ball Bearing	6007VV	1
32	WP2510-232A	S-Ring		1
33	WP2510-233	Chain	#40 x 58P	1
34	WP2510-234	Chain	#40 x 74P	1
35	TS-1505081	Socket Head Cap Screw	M10x50	4
36	TS-1551071	Lock Washer	M10	6
37	WP2510-237	Pin		4
38	TS-1505021	Socket Head Cap Screw	M10x20	7
39	WP2510-239	Spring Support Shaft		2
40	TS-1524021	Set Screw	M8x10	12
41	WP2510-241	Left Cutterhead Base		1
42	WP2510-242	Cutterhead Base Support Shaft		2
43	WP2510-243	Chipbreaker Support Shaft		1
44	6012167	Infeed Roller		24
45	6012168	Shaft		144
46	6012169	Spring		144
47	WP2510-247	Anti-Kickback Finger Support Shaft		2
48	6012164	Infeed Roller Spacer		2
49	WP2510-249A	Right Cutterhead Base		1
50	6012116	Washer		1
51	WP2510-251	Cutterhead Pulley		1
52	WP2510-252	Socket Head Cap Screw (Left Thread)	M10x20	1
53	TS-1550071	Flat Washer	M10	1
54	WP2510-254	Sprocket	26T	1
55	6012178	Anti-Kickback Finger		70
56	6012161	Washer		12

57.....	6012163.....	Shaft.....	6
58.....	6012162.....	Spring.....	6
59.....	WP2510-259.....	Right Bracket.....	1
60.....	WP2510-260.....	Key.....	8x7x16 1
61.....	6012175.....	Spring.....	11
63.....	WP2510-263.....	Infeed Roller Shaft.....	1
64.....	TS-1505041.....	Socket Head Cap Screw.....	M10x30 2
65.....	WP2510-265.....	Left Bracket.....	1
66.....	6012174.....	Chipbreaker.....	11
67.....	WP2510-267.....	Chain.....	#40 x 24P 1
68.....	JWP208HH-111.....	Knife Insert Screw.....	#10-32 x 1/2" 174
69.....	1791212.....	Knife Insert (sold as set of 10).....	174
70.....	JJ6HH-113.....	Star Point Screwdriver (not shown).....	2

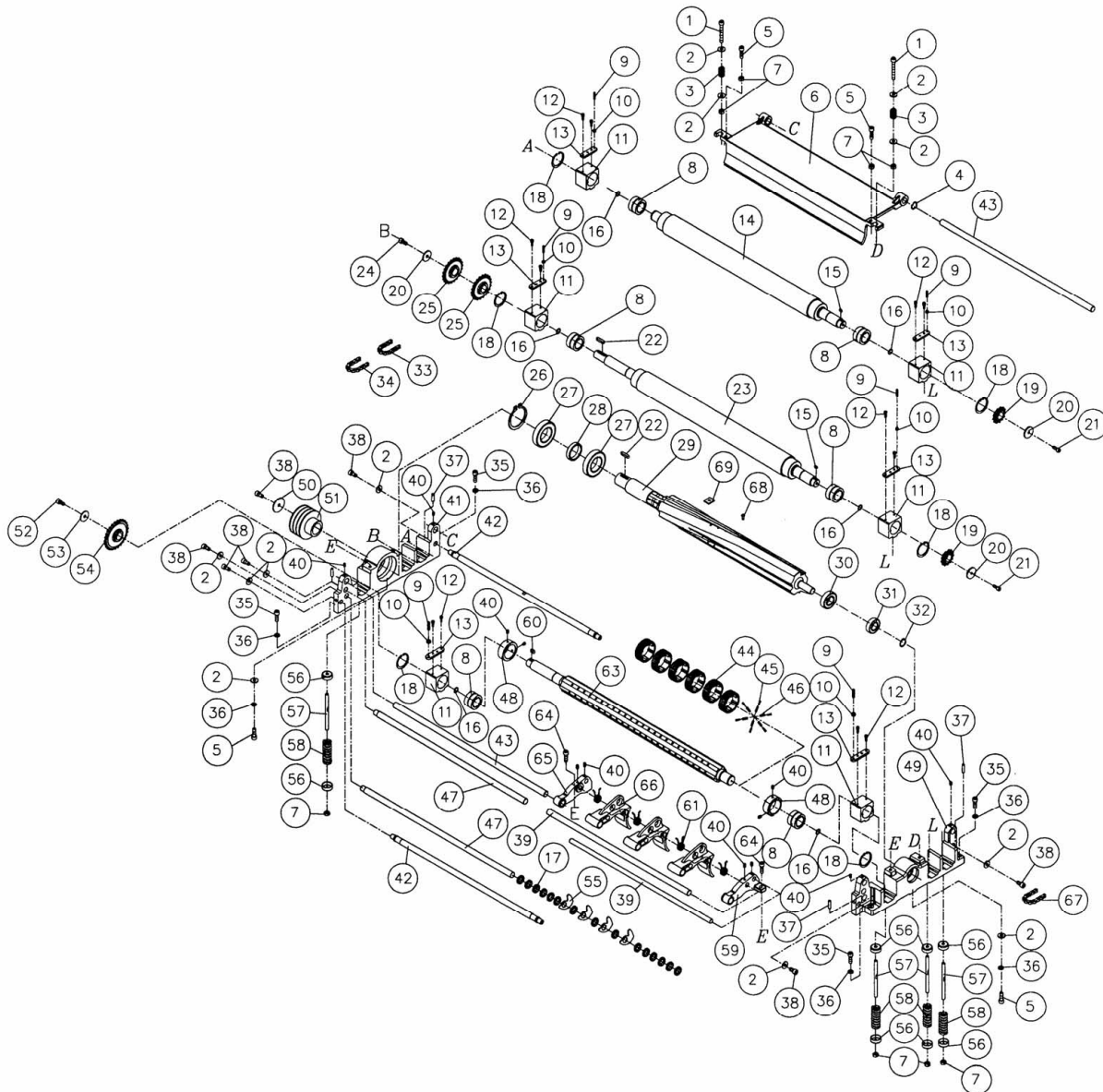
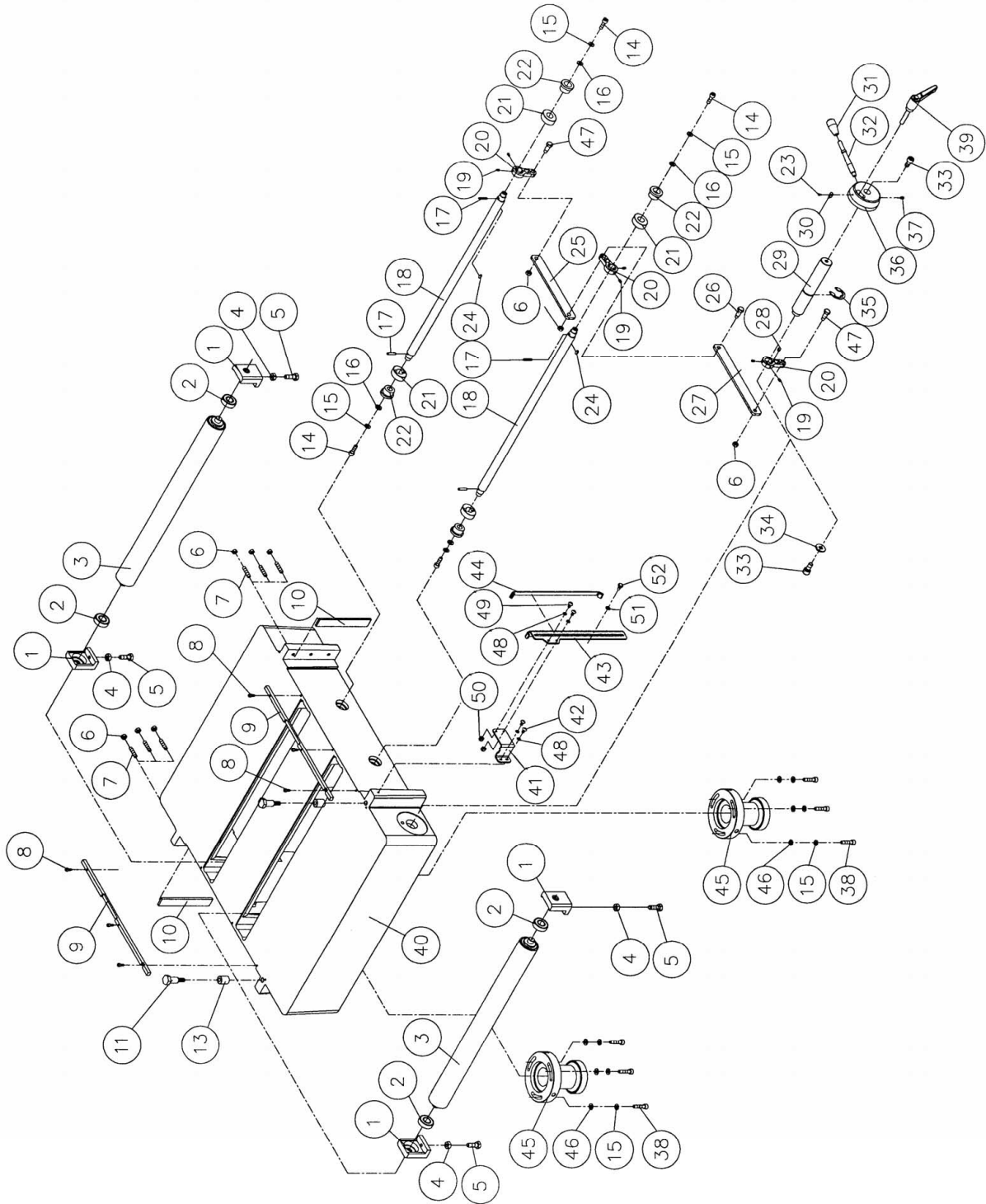

Table Assembly



Parts List: Table Assembly

Index No.	Part No.	Description	Size	Qty
1	WP2510-501	Roller Bracket		4
2	BB-6203VV	Ball Bearing	6203VV	4
3	WP2510-503	Roller		2
4	TS-1540071	Hex Nut	M10	4
5	TS-1491041	Hex Cap Screw	M10x30	4
6	TS-1540061	Hex Nut	M8	9
7	WP2510-507	Set Screw	M8x40	6
8	TS-1502091	Socket Head Cap Screw	M5x40	6
9	WP2510-509	Guide		2
10	6012241	Plate		2
11	WP2510-511	Shoulder Screw		2
13	6012239	Sleeve		2
14	TS-1504051	Socket Head Cap Screw	M8x25	4
15	TS-1551061	Lock Washer	M8	10
16	TS-1550061	Flat Washer	M8	4
17	WP2510-517	Pin		4
18	WP2510-518	Transfer Roller		2
19	TS-1522021	Set Screw	M5x8	6
20	6012248	Linking Plate		3
21	6012261	Eccentric Cam		4
22	6012260	Shaft		4
23	TS-2171012	Pan Head Screw	M4x6	1
24	WP2510-111	Key	5x5x10	2
25	WP2510-525	Rear Linking Plate		1
26	6012258	Shoulder Screw		1
27	WP2510-527	Front Linking Plate		1
28	WP2510-528	Key	5x5x8	1
29	6012249	Shaft		1
30	WP2510-530	Pointer		1
31	6012214	Handle Knob		1
32	6012213	Handle Shaft		1
33	TS-1505021	Socket Head Cap Screw	M10x20	2
34	TS-1550071	Flat Washer	M10	1
35	WP2510-535	E-Clip		1
36	6012252	Hub		1
37	TS-1523021	Set Screw	M6x8	1
38	TS-1504081	Socket Head Cap Screw	M8x40	6
39	6012253	Locking Handle		1
40	WP2510-540	Table		1
41	WP2510-541	Pointer		1
42	TS-2245102	Button Head Socket Screw	M5x10	2
43	WP2510-543	Slide Bracket		1
44	WP2510-544	Magnetic Bar		1
45	6012244	Table Adjusting Hub		2
46	TS-1550061	Flat Washer	M8	6
47	6012247	Shoulder Screw		1
48	TS-2361051	Lock Washer	M5	4
49	WP2510-549	Screw	M5x15	2
50	TS-1541011	Lock Nut	M5	2
51	WP2510-551	Wave Washer	M5	1
52	WP2510-552	Shoulder Screw		1

Base Assembly

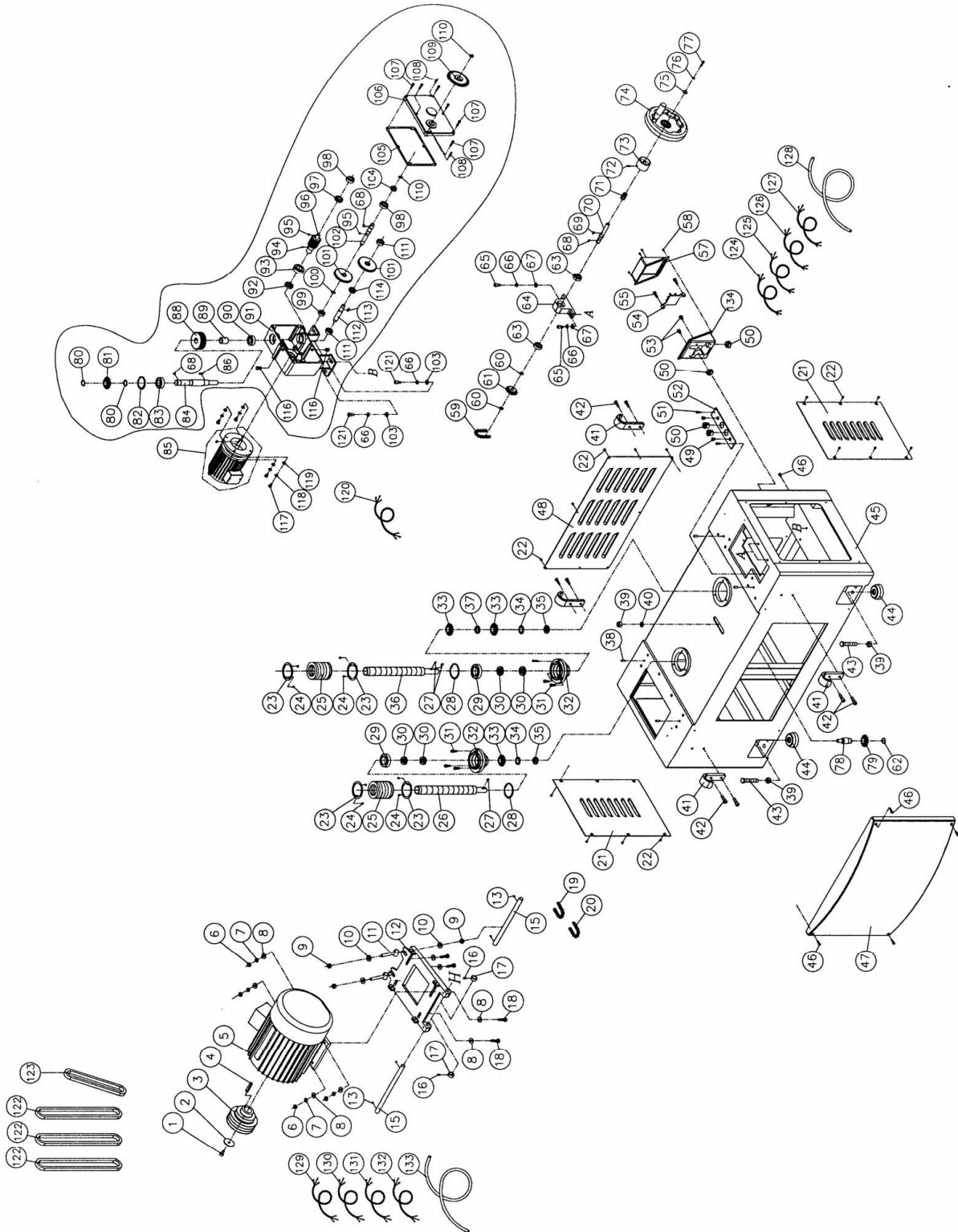

Parts List: Base Assembly

Index No.	Part No.	Description	Size	Qty
1	TS-1504031	Socket Head Cap Screw	M8x16	1
2	TS-1550061	Flat Washer	M8	1
3	WP2510-603	Motor Pulley		1
4	WP2510-604	Key	10x8x56	1
5	WP2510-605	Main Motor	15HP, 230/460V, 3Ph	1
6	TS-1540071	Hex Nut	M10	4
7	TS-2361101	Lock Washer	M10	4
8	TS-1550071	Flat Washer	M10	8
9	TS-1540081	Hex Nut	M12	4
10	TS-2360121	Flat Washer	M12	4
11	6012123	Adjusting Bolt		2
12	WP2510-612	Motor Plate		1
13	TS-1523051	Set Screw	M6x16	4
15	6012126	Shaft		2
16	TS-1524021	Set Screw	M8x10	2
17	6012125	Spacer		2
18	TS-1491081	Hex Cap Screw	M10x50	4
19	WP2510-619	Chain	#40 x 54P	1
20	WP2510-620	Chain	#40 x 84P	1
21	WP2510-621	Side Cover		2
22	TS-2246102	Button Head Socket Screw	M6x10	20
23	6012071	Bushing		4
24	6012070	Washer Head Screw	M4x8	8
25	6012068	Rubber Boot		2
26	6012069	Driven Lead Screw		1
27	WP2510-111	Key	5x5x10	3
28	WP2510-628	C-Ring		2
29	BB-6008VV	Ball Bearing	6008VV	2
30	BB-51105	Thrust Bearing	51105	4
31	TS-1504041	Socket Head Cap Screw	M8x20	6
32	6012075	Bracket		2
33	WP2510-633	Sprocket		3
34	WP2510-634	Star Washer	M25	2
35	WP2510-635	Special Nut		2
36	WP2510-636	Drive Lead Screw		1
37	WP2510-637	Washer		1
38	WP2510-638	Pin		4
39	TS-154010	Hex Nut	M16	5
40	TS-155010	Flat Washer	M16	1
41	WP2510-641	Hanger		4
42	TS-1505041	Socket Head Cap Screw	M10x30	4
43	WP2510-643	Leveling Screw	M16x80	4
44	6012095	Pad		4
45	WP2510-645	Base		1
46	TS-1503021	Socket Head Cap Screw	M6x10	5
47	WP2510-647	Front Cover		1
48	WP2510-648	Rear Cover		1
49	WP2510-649	Strain Relief		2
50	WP2510-650	Strain Relief		4
51	TS-1503041	Socket Head Cap Screw	M6x16	2
52	WP2510-652	Plate		1
53	TS-1504011	Socket Head Cap Screw	M8x10	2
54	WP2510-654	Terminal Plate		1
55	TS-1504051	Socket Head Cap Screw	M8x25	2
57	WP2510-657	Junction Box Cover		1
58	TS-1533032	Pan Head Screw	M5x10	4
59	WP2510-233	Chain	#40 x 58P	1

60	WP2510-660	S-Ring		2
61	WP2510-661	Sprocket		1
62	WP2510-662	S-Ring		1
63	BB-6203VV	Ball Bearing	6203VV	2
64	WP2510-664	Housing		1
65	TS-1505021	Socket Head Cap Screw	M10x20	2
66	TS-1551071	Lock Washer	M10	6
67	TS-1550071	Flat Washer	M10	2
68	WP2510-215	Key	5x5x12	2
69	WP2510-669	Key	5x5x15	1
70	WP2510-670	Hand Wheel Shaft		1
71	WP2510-671	Spring		1
72	TS-1523051	Set Screw	M6x16	1
73	WP2510-673	Bushing		1
74	WP2510-674	Hand Wheel Assembly		1
75	TS-1550041	Flat Washer	M6	1
76	TS-1551041	Lock Washer	M6	1
77	TS-1503051	Socket Head Cap Screw	M6x20	1
78	WP2510-678	Shaft		1
79	WP2510-679	Sprocket		1
	WP2510-GBA	Gearbox Assembly (#68, #80-#84, #86, #88-#102, #104-#114, #116)		1
80	WP2510-680	S-Ring		2
81	WP2510-681	Sprocket		1
82	WP2510-682	C-Ring		1
83	BB-6205ZZ	Ball Bearing	6205ZZ	1
84	WP2510-684	Shaft		1
85	WP2510-685	Motor	1/2HP, 230/460V, 3Ph	1
86	WP2510-686	Key	5x5x22	1
88	WP2510-688	Gear		1
89	WP2510-689	Bushing		1
90	BB-6204ZZ	Ball Bearing	6204ZZ	1
91	WP2510-691	Gearbox		1
92	WP2510-692	Oil Seal		1
93	BB-6205ZZ	Ball Bearing	6205ZZ	1
94	TS-1524011	Set Screw	M8x8	1
95	WP2510-111	Key	5x5x10	2
96	WP2510-696	Worm		1
97	WP2510-697	Gear	24T	1
98	BB-6203ZZ	Ball Bearing	6203ZZ	2
99	BB-6201ZZ	Ball Bearing	6201ZZ	1
100	WP2510-6100	S-Ring		1
101	WP2510-6101	Gear	60T	1
102	WP2510-6102	Shaft		1
103	TS-1550071	Flat Washer	M10	4
104	WP2510-6104	Oil Seal		1
105	WP2510-6105	Gasket		1
106	WP2510-6106	Gearbox Cover		1
107	TS-1503061	Socket Head Cap Screw	M6x25	6
108	WP2510-6108	Pin		2
109	WP2510-6109	Sprocket		1
110	WP2510-6110	S-Ring		2
111	BB-6202ZZ	Ball Bearing	6202ZZ	1
112	WP2510-6112	Shaft		1
113	WP2510-124	Key	5x5x20	1
114	WP2510-6114	Gear	20T	1
116	WP2510-6116	Oil Plug		2
117	TS-1490041	Hex Cap Screw	M8x25	4
118	TS-2361081	Lock Washer	M8	4
119	TS-1550061	Flat Washer	M8	4
120	WP2510-6120	Motor Cord		1
121	TS-1505041	Socket Head Cap Screw	M10x30	4

122	VB-A86	V-Belt	A86	3
123	VB-A57	V-Belt	A57	1
	WP2510-PCA	Power Cord Assembly (#124 - #128)		1
124	WP2510-6124	Red Cord		1
125	WP2510-6125	White Cord		1
126	WP2510-6126	Black Cord		1
127	WP2510-6127	Grounding Cord		1
128	WP2510-6128	Casing		1
	WP2510-MCA	Main Motor Cord Assembly (#129 - #133)		1
129	WP2510-6129	Red Cord		1
130	WP2510-6130	White Cord		1
131	WP2510-6131	Black Cord		1
132	WP2510-6132	Grounding Cord		1
133	WP2510-6133	Casing		1
134	WP2510-6134	Junction Box		1

Parts List: Top Cover Assembly

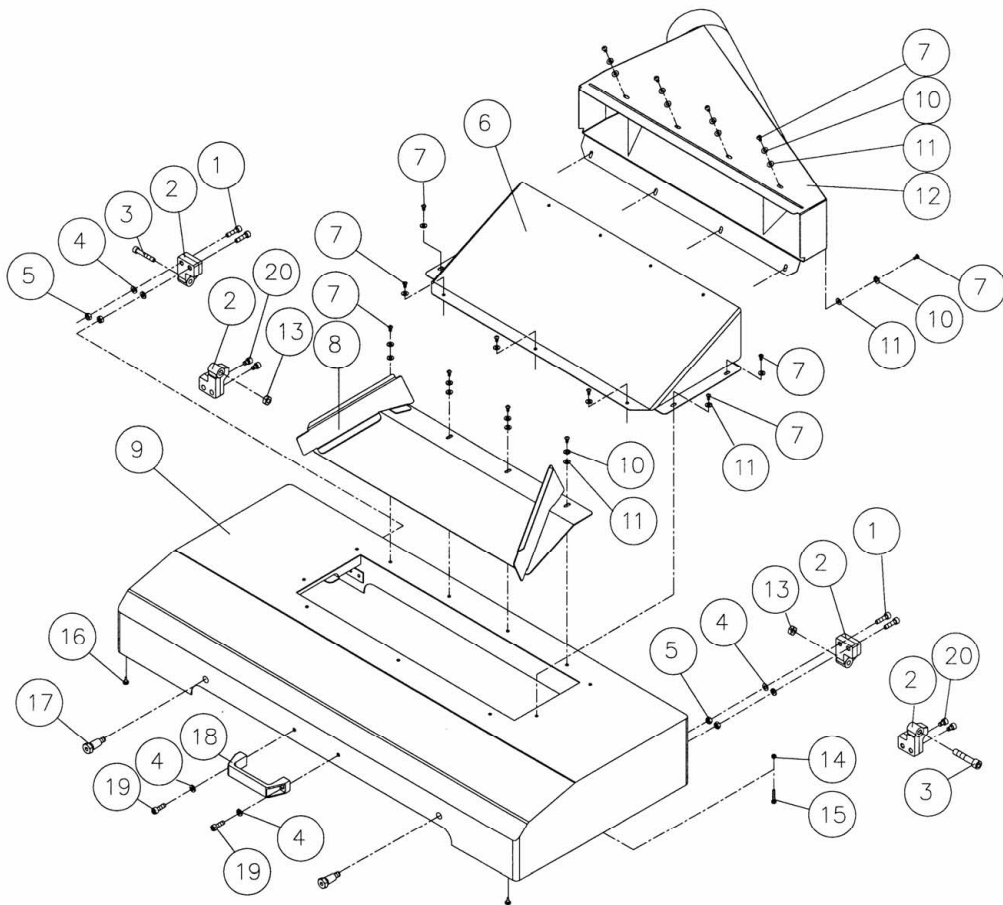

Index No.	Part No.	Description	Size	Qty
1	TS-1504061	Socket Head Cap Screw	M8x30	4
2	WP2510-302	Hinge		4
3	TS-1505111	Socket Head Cap Screw	M10x70	2
4	TS-1551061	Lock Washer	M8	6
5	TS-1540061	Hex Nut	M8	4
6	WP2510-306	Upper Cover		1
7	TS-2246122	Button Head Socket Screw	M6x12	19
8	WP2510-308	Deflection Plate		1
9	WP2510-309	Top Cover		1
10	TS-2361061	Lock Washer	M6	19
11	TS-1550041	Flat Washer	M6	19
12	6012181	Dust Chute		1
13	TS-1541041	Nylon Insert Lock Nut	M10	2
14	TS-1540031	Hex Nut	M5	4
15	TS-1481061	Hex Cap Screw	M5x25	2
16	WP2510-316	Pad		2
17	6012190	Shoulder Screw		2
18	6012189	Handle		1
19	TS-1504051	Socket Head Cap Screw	M8x25	2
20	TS-1504071	Socket Head Cap Screw	M8x35	4

Parts List: Electrical Box Assembly

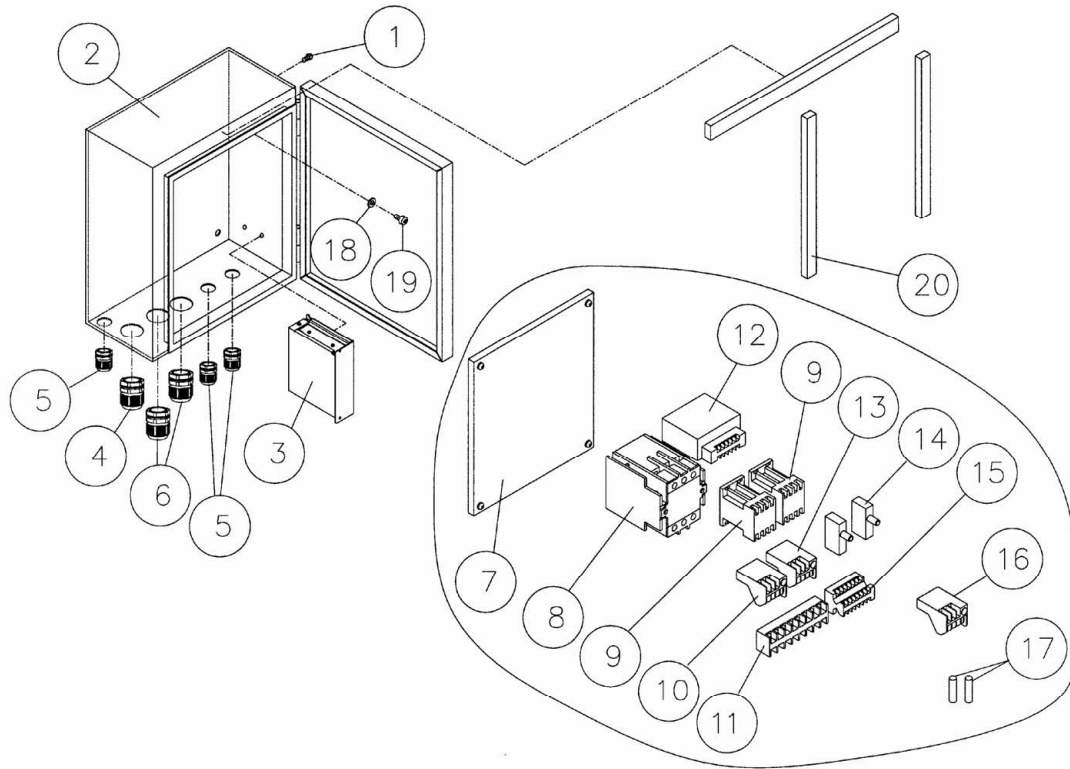

Index No.	Part No.	Description	Size	Qty
1	TS-1531012	Screw	M3x6	2
2	WP2510-702	Electrical Box		1
3	WP2510-703	Power Supply		1
4	WP2510-704	Strain Relief		1
5	WP2510-705	Strain Relief		3
6	WP2510-706	Strain Relief		2
	WP2610-EBA	Electrical Board Assembly (#7 - #17)		1
7	WP2510-707	Electrical Board		1
8	WP2510-708	Contactor (for 15HP Motor)		1
9	WP2510-709	Contactor (for 1/2HP Motor)		2
10	WP2510-710	Overload (for 230V, Big Conductor)	RA-30 (32-50A)	1
11	WP2510-711	Terminal Board		1
12	WP2510-712	Transformer		1
13	WP2510-713	Overload (for Small Conductor)	RA-20 (1.6-2.5A)	1
14	WP2510-714	Fuse Support Base		2
15	WP2510-715	Terminal Board		1
16	WP2510-716	Overload (for 460V, Big Conductor)	RA-30E (18-26A)	1
17	WP2510-717	Fuse	250V, 2A	4
18	TS-1550041	Flat Washer	M6	4
19	TS-1503031	Socket Head Cap Screw	M6x12	4
20	WP2510-720	Padding		3

Electrical Connections – 230Volt

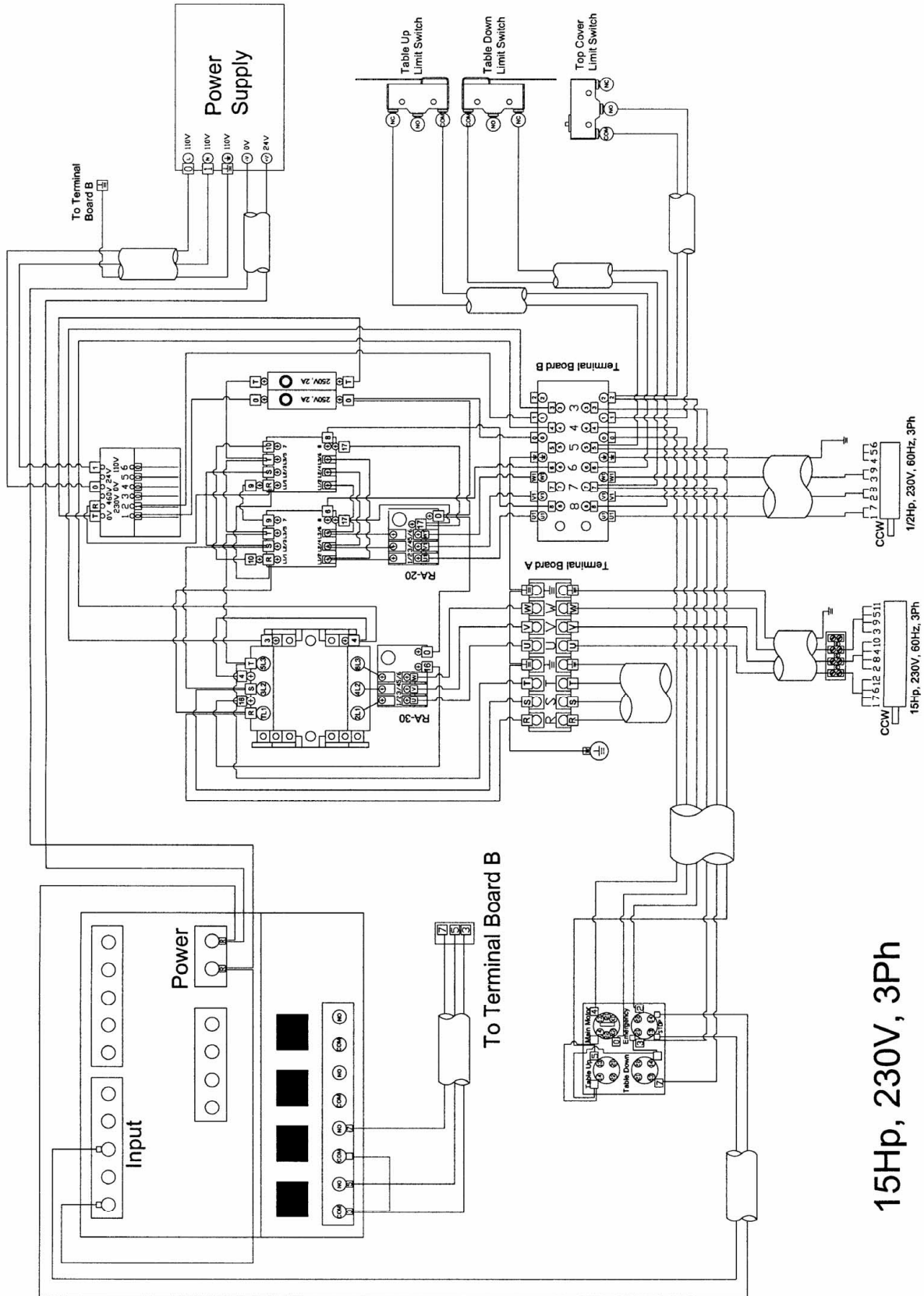

15Hp, 230V, 3Ph

Electrical Connections – 460Volt

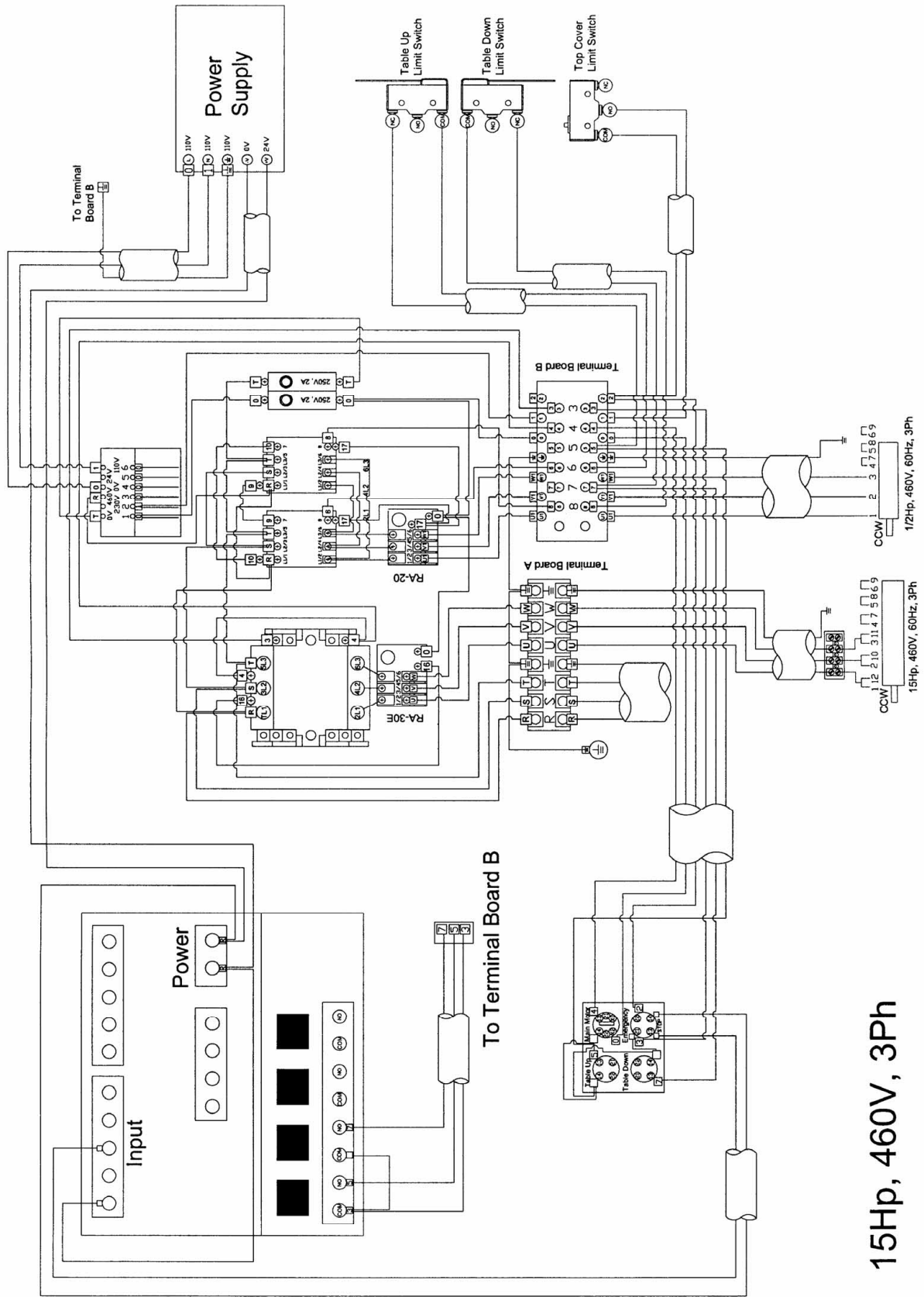

15Hp, 460V, 3Ph

POWERMATIC[®]

WMH Tool Group
2420 Vantage Drive
Elgin, Illinois 60124
Phone: 800-274-6848
www.wmhtoolgroup.com