

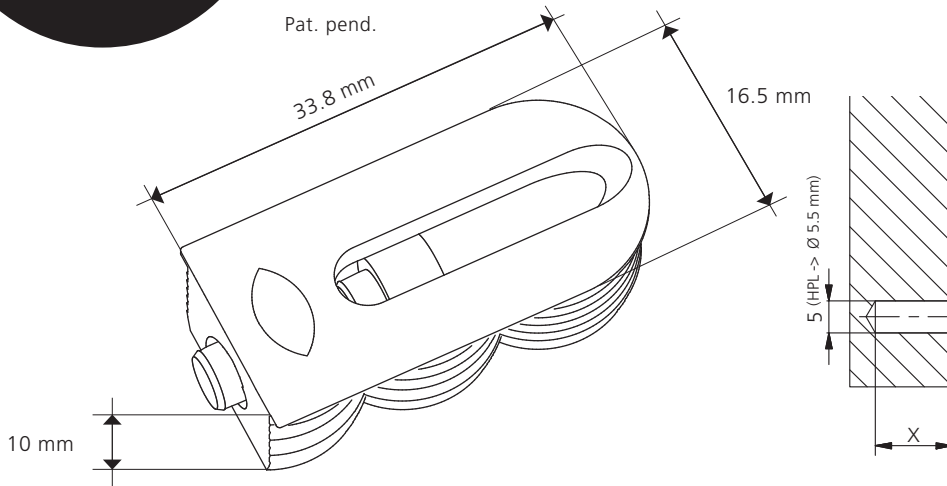

Cabineo

Pat. pend.



Bearbeitung: Seite

Machining: Side panel

Bohrer / Drill \varnothing 5 mm
(HPL -> \varnothing 5.5 mm)

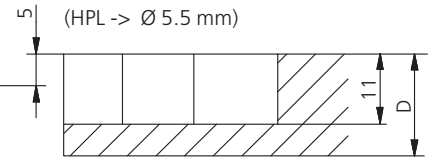

Cabineo 8: X = 8 mm, schwarze Schraube / black screw

Cabineo 12: X = 12 mm, vernickelte Schraube / nickel-plated screw

Bearbeitung: Boden, Zwischenboden oder Deckel / Machining: Bottom, top or fixed shelf

Alle Angaben in mm / All details in mm
Download CAD: www.lamello.com

Variante / Option 1:

Bohrer \varnothing 15 mm

Drill \varnothing 15 mm

Variante / Option 2:

Fräser \varnothing 10 mm oder kleiner

Cutter \varnothing 10 mm or smaller

Variante / Option 3:

Fräser \varnothing 12 mm

Cutter \varnothing 12 mm

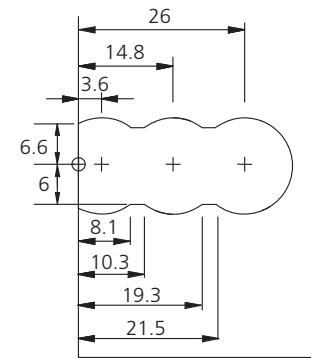
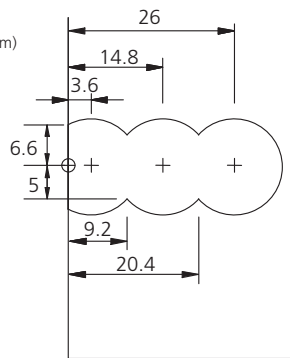
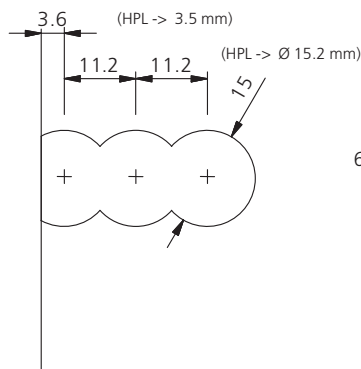
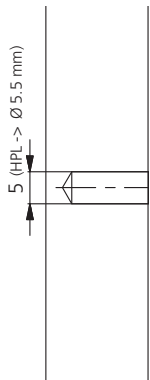

Bearbeitung mit allen CNC-Maschinen / Machining with all CNC machines:

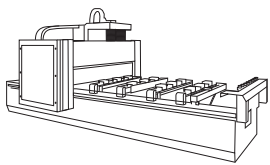

CNC-Bearbeitungszentren mit **Konsolen**

CNC processing centres with **consoles**

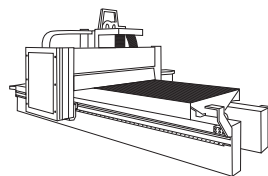

CNC-Bearbeitungszentren mit **Nesting-Technologie**

CNC processing centres with **nesting technology**

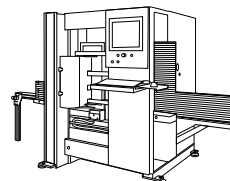

Vertikale
CNC-Bearbeitungszentren

Vertical CNC
processing centres

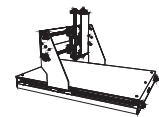

CNC **Oberfräse**
CNC **router**

Montage / Assembly:

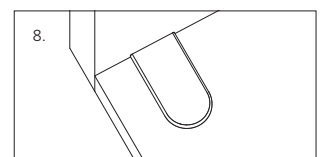
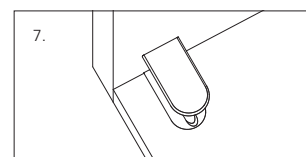
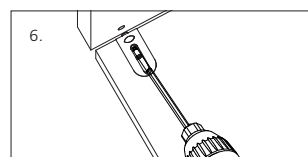
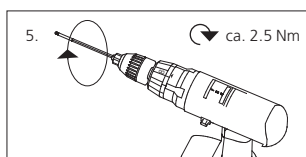
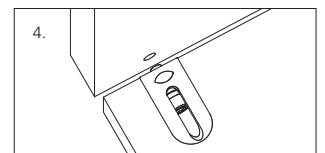
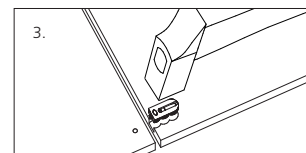
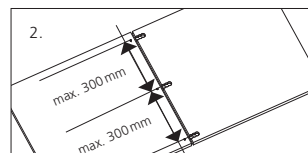
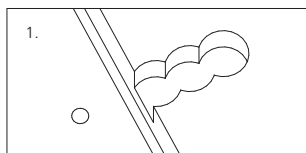

Keine Holzdübel notwendig! / No dowel necessary!

keine Kantenbearbeitung / weniger Bohrungen / weniger Werkzeugwechsel / keine Dübelmontage
No edge drilling / less drill holes / less tool change / no pre-assembly of dowel



Anwendungen / Applications:

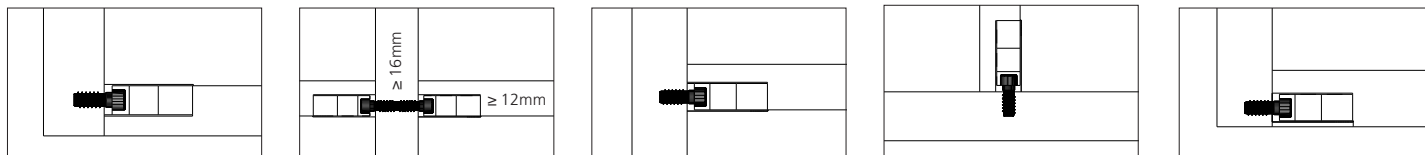

Technische Informationen / Technical information:

Festigkeit pro Verbinder ohne Dübel / Technical values without dowel (N)

in Spanplatte / in particule board	Cabineo 12	Cabineo 8	Exzenter
19 mm			
Zugfestigkeit / Tensile strength (F1)	900	500	500
Scherfestigkeit / Shear strength (F2)	850	550	550
Scherfestigkeit / Shear strength (F3) [Var.3]	400 [-13%]	400 [-13%]	450
Spannkraft / Clamping force (F4)	900	500	-

Zugfestigkeit / Tensile strength (N)

Div. Material	Cabineo 8
12 mm	
HPL	900
Multiplex	900
CDF	600
MDF	400

10 N ~ 1kg

10 N ~ 1kg

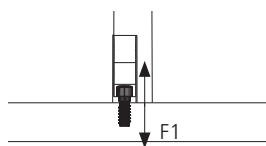

Zugfestigkeit / Tensile strength

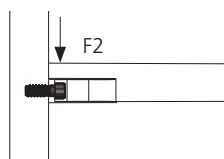

Scherfestigkeit / Shear strength

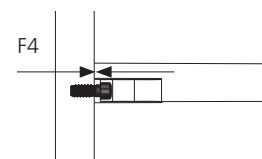
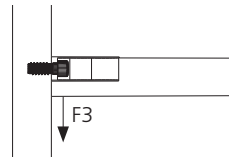

Spannkraft / Clamping force

Technische Daten

Grösse	33.8 x 16.5 x 10.8 mm
Fräser	Ø 12 mm oder kleiner
Bohrer	Ø 5 mm und Ø 15 mm
Material Gehäuse	Glasfaserverstärkter Kunststoff
Einbautoleranz	Längs ± 0.1 mm

Technical data

Size	33.8 x 16.5 x 10.8 mm
Cutter	Ø 12 mm or smaller
Drill	Ø 5 mm and Ø 15 mm
Material housing	Fibre-glass reinforced plastic
Installation tolerace	Longitudinal ± 0.1 mm

Artikel / Articles:

	Art.Nr.
Cabineo Starterset, Cabineo 8 + 12 (je 40 Stk), inkl. Cabineo Sechskant-Bit und Abdeckkappen (40 Stk).....	186305
Cabineo 8, für Mittelwände, 500 Stück	186310
Cabineo 8, für Mittelwände, 2000 Stück	186311
Cabineo 12, 500 Stück	186320
Cabineo 12, 2000 Stück.....	186321

	Art.No.
Cabineo Starter Set, Cabineo 8 + 12, 40 pcs each, Cabineo hex bit, set of cover caps	186305
Cabineo 8, for dividing panels, 500 pcs	186310
Cabineo 8, for dividing panels, 2000 pcs	186311
Cabineo 12, 500 pcs	186320
Cabineo 12, 2000 pcs	186321

Zubehör / Accessories:

Cabineo Werkzeug	Art.Nr.
Cabineo Werkzeug mit Griff.....	256300
Cabineo Sechskant-Bit	276312
Cabineo Bohrer Ø 15 mm mit Zentrierspitze 0.8 mm	136312
Cabineo Fräser Ø 10 mm.....	136310
Cabineo Fräser Ø 12 mm.....	136311

Cabineo Tool	Art.No.
Cabineo tool with handle	256300
Cabineo hex bit.....	276312
Cabineo drill Ø 15 mm with short centering point 0.8 mm..	136312
Cabineo cutter Ø 10 mm.....	136310
Cabineo cutter Ø 12 mm.....	136311

Cabineo Abdeckkappe	Art.Nr.	100 Stk.	2000Stk.
Signalweiss RAL 9003	186350S		186351S
Reinweiss RAL 9010	186350W		186351W
Papyrusweiss RAL 9018	186350P		186351P
Hellelfenbein RAL 1015	186350H		186351H
Fenstergrau RAL 7040	186350F		186351F
Braunbeige RAL 1011	186350B		186351B
Rehbraun RAL 8007	186350R		186351R
Mausgrau RAL 7005.....	186350A		186351A
Tiefschwarz RAL 9005.....	186350T		186351T

Cabineo Cover caps	Art.Nr.	100 pcs.	2000 pcs.
Signal white RAL 9003	186350S		186351S
Pure white RAL 9010	186350W		186351W
Papyrus white RAL 9018.....	186350P		186351P
Light ivory RAL 1015.....	186350H		186351H
Window grey RAL 7040	186350F		186351F
Brown beige RAL 1011.....	186350B		186351B
Fawn brown RAL 8007.....	186350R		186351R
Mouse grey RAL 7005.....	186350A		186351A
Jet black RAL 9005.....	186350T		186351T